

User manual

K-BUS Waltz series

KNX Smart Touch with push button&Secure,3-gang_V1.3

CHTFB-3.0/6.S.0x (Plastic)

CHTFB-3.0/6.S.2x (Metal)

(x=0: White; x=1: Black; x=2: Silver; x=3: Gray; x=4: Golden)



KNX/EIB Home and Building Control System

Attentions

1. Please keep devices away from strong magnetic field, high temperature, wet environment;

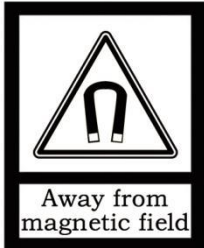

2. Do not fall the device to the ground or make them get hard impact;



3. Do not use wet cloth or volatile reagent to wipe the device;



4. Do not disassemble the devices.



Focus on the treatment of the following:

- (1) Under the process of software upgrade, interrupting the power supply may cause the system to fail to start;**
- (2) Make sure that the USB is completely empty before inserting, that is, no data with embedded system firmware is programmed, otherwise the system may be damaged;**
- (3) If the power supply needs to be interrupted after modifying the setting information, it is recommended that the power can be cut off after 6 seconds when complete modifying, otherwise the modification may not be successful;**
- (4) If the auxiliary power supply is power off when the screen is on, the screen may display with a tiny flashing after the power recovery in the next time. At this case, let the device continuously power on for a period of time (maximum around half an hour), the screen will automatically recover to the normal display state**

In the above (1), the device need to return to the factory for maintenance, please be careful to deal with.

Contents

Chapter 1 Summary	1
Chapter 2 Technical Data	3
Chapter 3 Dimension and Structural Diagram	4
3.1 Dimension Diagram	4
3.2 Structural Diagram	5
Chapter 4 Project Design and Programming	6
Chapter 5 Parameter setting description in the ETS	10
5.1. Parameter window "General"	14
5.1.1. Parameter window "General setting"	14
5.1.2. Parameter window "Screen saver setting"	19
5.1.3. Parameter window "Security setting"	23
5.1.4. Parameter window "Night mode setting"	25
5.1.5. Parameter window "Summer time setting"	29
5.1.6. Parameter window "Proximity setting"	31
5.1.7. Parameter window "Alarm setting"	32
5.1.8. Parameter window "Advanced setting"	34
5.2. Parameter window "Internal temperature measurement"	35
5.3. Parameter window "Input"	39
5.3.1. Temperature probe	40
5.3.2. Binary input	43
5.4. Parameter window "HVAC controller"	47
5.4.1. Parameter window "Controller x - RTC"(x=1~6)	48
5.4.1.1. Parameter window "Setpoint"	55
5.4.1.2. Parameter window "Heating/Cooling control"	62
5.4.1.3. Parameter window "Fan auto.control"	69
5.4.2. Parameter window "Controller x - Ventilation"(x=1~6)	73
5.5. Parameter window "Home page"	79
5.5.1. Parameter window "Function"	79
5.5.2. Parameter window "Icon x"(x=1~6)	81
5.6. Parameter window "Function page setting"	85
5.6.1. Parameter window "Page x"(x=1~6)	85

5.6.2. Parameter window "Icon x"(x=1~6)	86
5.6.2.1. Parameter of basic function	88
5.6.2.2. Parameter of air condition	106
5.6.2.3. Parameter of room temperature unit	113
5.6.2.4. Parameter of ventilation system	119
5.6.2.5. Parameter of audio control	123
5.6.2.6. LED indication function	127
5.7. Parameter window "Button"	129
5.7.1. Button function setting	130
5.7.1.1. Switch function	131
5.7.1.2. Dimming function	133
5.7.1.3. Value sender function	135
5.7.1.4. Scene function	136
5.7.1.5. Blind function	137
5.7.1.6. Shift register function	138
5.7.1.7. Multiple operation function	140
5.7.1.8. Delay mode function	142
5.7.1.9. RTC mode function	143
5.7.1.10. Sting function	145
5.7.1.11. LED indication function	146
5.7.2. Customized linking setting	150
5.7.3. Parameter window "Customized colour"	153
5.8. Parameter window "Logic"	153
5.8.1. Parameter window "AND/OR/XOR"	155
5.8.2. Parameter window "Gate forwarding"	157
5.8.3. Parameter window "Threshold comparator"	159
5.8.4. Parameter window "Format convert"	161
5.8.5. Parameter window "Gate function"	162
5.8.6. Parameter window "Delay function"	164
5.8.7. Parameter window "Staircase lighting"	165
5.9. Parameter window "Scene Group"	166
Chapter 6 Description of Communication Object	169
6.1. "General" Communication Object	169
6.2. "Internal sensor" Communication Object	174

6.3. "Input" Communication Object	175
6.4. "HVAC controller" Communication Object	178
6.4.1. "Room temperature controller" Communication Object	178
6.4.2. "Ventilation controller" Communication Object	184
6.5. "Home page" Communication Object	185
6.6. "Function page setting" Communication Object	187
6.6.1. Communication Object of Basic function	187
6.6.2. Communication Object of Air condition	199
6.6.3. Communication Object of Room temperature unit	202
6.6.4. Communication Object of Ventilation system	205
6.6.5. Communication Object of Audio control	208
6.7. "Button" Communication Object	211
6.8. "Logic" Communication Object	218
6.8.1. "AND/OR/XOR" Communication Object	218
6.8.2. "Gate forwarding" Communication Object	219
6.8.3. "Threshold comparator" Communication Object	220
6.8.4. "Format convert" Communication Object	221
6.8.5. "Gate function" Communication Object	223
6.8.6. "Delay function" Communication Object	225
6.8.7. "Staircase lighting" Communication Object	226
6.9. "Scene Group" Communication Object	227

Chapter 1 Summary

KNX Smart Touch with push button,3-gang not only supports screen touch operation, but also supports button operation, bringing a sense of dual experience while integrating functions such as Dimming, Curtain, Scene, Room temperature controller, Air conditioning, Ventilation system, Audio control, RGB and RGBW dimming, Colour temperature dimming, and Status display, and built-in temperature and humidity sensors to detect local environment temperature and humidity, meeting most daily applications.

In addition, the series products support Logic function and Scene Group function, and 2 external input interfaces (as Binary input detection or NTC detection), provide more possibilities for special and complex applications. Also support practical and convenient functions such as Proximity sense, Screen saver, Panel block, Password access and etc.

Specially, the button panel can be linked to the function devices on touch screen as shortcut button, or used as normal push button. When used as shortcut button, users can customize the linking, according to their requirements, flexible and changeable. When used as normal push button, individual functions can be configured independently, basic functions include Switch, Dimming, Curtain, Value sender, Shift register, Multiple operation, Delay mode, RTC operation mode and Send string.

KNX Smart Touch with push button,3-gang powered from KNX bus, and need a 12-30V DC auxiliary supply voltage. It is available to assign the physical address and configure the parameters by engineering design tools ETS with .knxprod (support edition ETS5.7 or higher).

Note: Do not use the physical address 15.15.254, which is used in production test mode.

The functions are summarized as followed:

- 3.0 inch colour IPS capacitive touch screen, resolution 854x480
- Home page function, support to display air quality information or scene function
- With basic control functions including switching, dimming, blinds, scenes,etc. And other control functions including colour and colour temperature control, audio control, HVAC control (Room temperature control, Air conditioner and Ventilation).
- Information and status indicator
- Scene Group functions, Logic functions
- Password access, Panel locking, and Screensaver
- Proximity sense, screen brightness setting
- Built-in temperature and humidity sensor
- Day/Night signal and summer time automatic adjustment
- Support customized image resource replacement
- Support 2 external input interfaces, used as dry contact detection or NTC temperature detection
- Push button as Customized linking to touch or Push button sensor, and with RGB indications
- KNX Data Secure

Chapter 2 Technical Data

Power Supply	Bus voltage	21-30V DC, via the KNX bus
	Bus current	<4mA, 24V <3.5mA, 30V
	Bus consumption	<105mW
Auxiliary Supply	Voltage	12-30V DC
	Current	<81.5mA, 24V; <66mA, 30V
	Consumption	<2W
Input	2 external inputs, as dry contact input or 10K NTC input	
Micro USB	Update UI firmware, or import background image or icon	
Proximity sensor	Approximately 30cm	
Connection	KNX	Bus connection terminal(Red/Black)
	Auxiliary Supply	Bus connection terminal(Yellow/White)
	Micro USB socket	
	Input	Screw terminals, Wire Range: 0.2-2.5mm ² Torque 0.4N-m Length <5m
Temperature	Operation	- 5 °C ... +45 °C
	Storage	- 25 °C ... +55 °C
	Transport	- 25 °C ... +70 °C
Environment	Humidity	<93%, except dewing
Dimension	86 × 115 × 34.7mm	
Weight	0.15kg	

Chapter 3 Dimension and Structural Diagram

3.1 Dimension Diagram

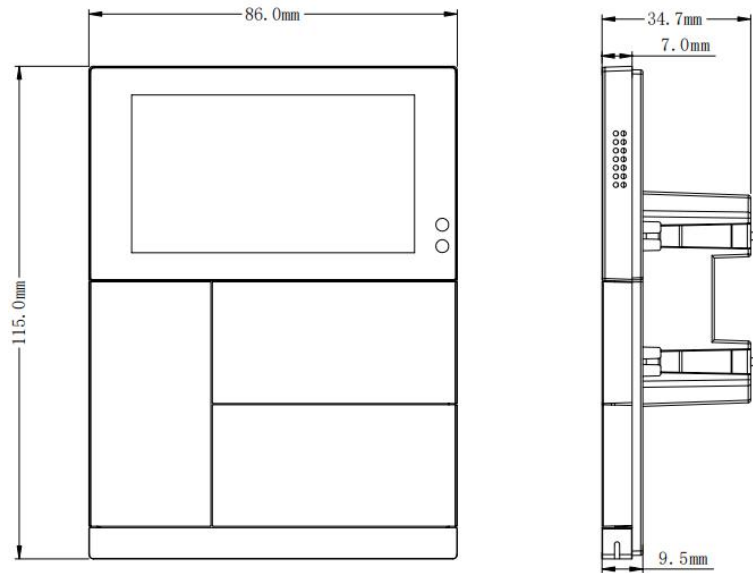

Panel dimension

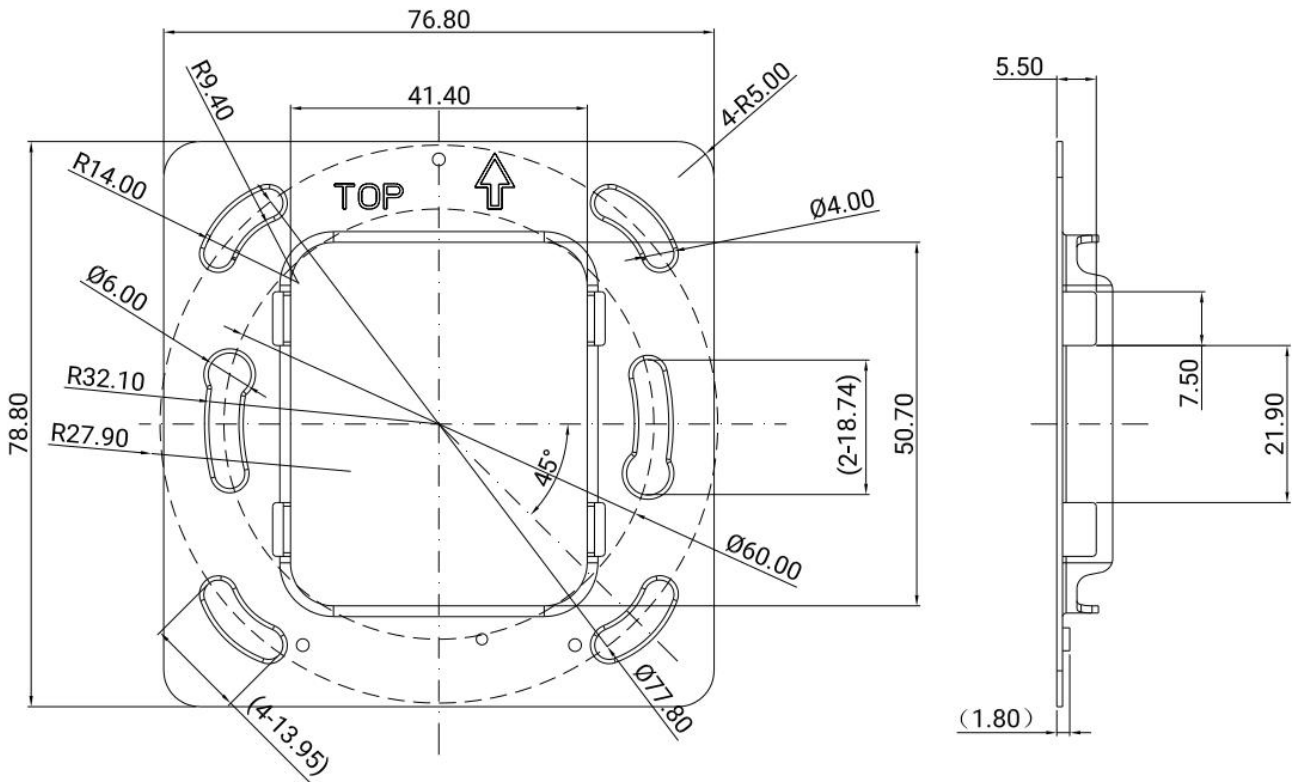

Metal plate dimension

3.2 Structural Diagram

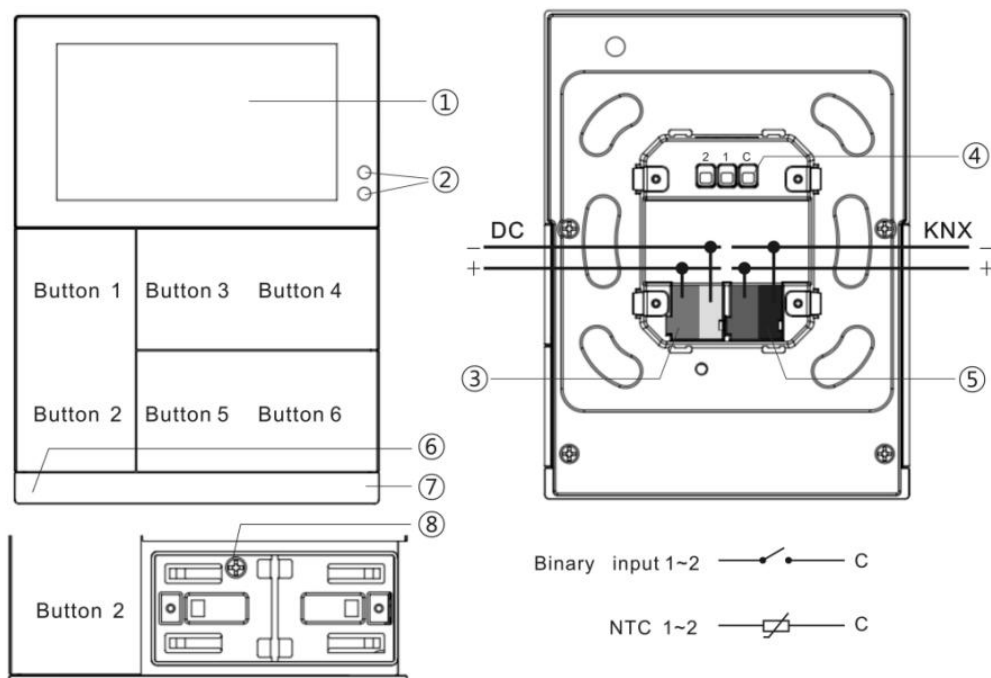

- ① Touch and display area
- ② Proximity sensor
- ③ Auxiliary supply connection terminal
- ④ Input terminals
- ⑤ KNX bus connection terminal
- ⑥ Micro USB socket
- ⑦ Internal temperature and humidity sensor
- ⑧ Fit bolt for anti-theft protection (included with the rocker cover)

Note: The programming of the physical address needs to be entered into the setting interface of

the screen, then click the icon  to turn on or off the programming mode.

(Note: First remove the four screws at the bottom of the panel, open the back cover, and then the programming button will be visible.)

Chapter 4 Project Design and Programming

Application	Maximum of communication objects	Maximum number of group addresses	Maximum number of associations	Secure group addresses
KNX Smart Touch with push button&Secure,3-gang/1.1	1023	2000	2000	1500

General function

General function includes device In operation setting, KNX telegrams delay time setting, date and time update, request device status after voltage recovery, delay exit function setting automatically, and supports to lock the whole device.

Support whether to enable extension functions, including security password, screen display, screen brightness, screen saver, normal/night mode, proximity sense and alarm function.

Homepage setting

Homepage has 2 display styles optionally. Display styles: 4 types of status display or 2 scene controls. There is also support for displaying the information about status bar of temperature and humidity, and date, time and day of the week. Support delay automatic return to homepage or a function page.

Status display includes temperature, humidity, PM2.5, PM10, CO2, VOC, AQI, brightness, wind speed, rain.

Device controls currently support only Scene, used for configuring common functions.

AQI, PM2.5, PM10, VOC, CO2 and brightness are detected by external sensor, temperature and humidity can be selected internal or external.

Function page setting

Adopt the grid display style. Each icon function is configurable to link to a specific function point,

up to support 6 function pages. Layout for each page supports 4 or 6 icons, and supports for locking/unlocking each icon device independently.

Function points include basic control functions, containing switching, dimming, blinds, scenes,etc. And other functions, containing colour and colour temperature control, audio control, HVAC control (Room temperature control, Air conditioner and Ventilation).

Switch, dimming, blinds, scenes, and colour and colour temperature can be selected with or without dynamic function and options.

External input interface function

Up to support 2 channels, enable/disable each channel functions. Optional dry contact detection or NTC temperature detection.

When selecting dry contact detection, only supports the basic functions, including switch, scene send strings (press/release, short/long, send after voltage recovery, disable function).

When selecting NTC temperature detection, the external temperature probe can be connected to detect the external temperature and the B value data of temperature sensing probe needs to be set.

Button function

Button can be configured as independent panel functions or linked to touch functions. Each button can activate disable function.

When configured to link to touch function, can preset the desired associated devices. And can set linked any security passwords to enter the advanced configuration.

When as independent panel functions, support basic functions, including switch, dimming, blind, scene, value sender, shift register, multiple operation, delay mode, RTC operation mode, send strings. Can be configured long and short operation to select common 1 object or separate 2 objects.

Indication LED function

Brightness level of indication LED is adjustable, and adjusted according to normal/night status. When screen is off, then LED will also be off, and it will be on at the same time when waking up. Indication LED setting according to button configuration:

When the button is configured as independent panel functions, support configuration as follow:

①Disable, Control by button switch object, Control by external object (1bit/1byte), Indicate button press (Flash and Always on), Always on.

②The LED indication colours can be set independently. When customized colours are used, Customized colour configuration is required.

When the button is configured as customized linking to touch, support configuration as follow:

①For the shortcut button with status feedback, LED indication responds according to the status:

a. For the function with switch status feedback, ON when switch status on, OFF when switch status off;

b. For curtain/blind function, ON when position status>0, OFF when position status=0;

c. For scene function, ON when recall/store the scene, otherwise OFF.

②For the shortcut button without status feedback, such as scene(without status), value sender, room temperature unit, Air conditioner, Ventilation system and Audio control, these functions support the LED indication is including Disable, Always on, According to Power on/off and Indicate press.

③The LED indication colours can be set independently. When customized colours are used, Customized colour configuration is required.

HVAC controller

Up to support 6 controllers that can be set independently, used for linkage with Room temperature controller (RTC) or ventilation controller.

RTC: support to functions, including control mode input, heating/cooling system, operation mode and setpoint temperature, fan speed, window contact, presence detector, temperature threshold, 2 points and PI control algorithm and etc; At relative adjustment, extra optional whether to enable setpoint temperature offset value, with threshold option (-10~10°C), send the offset value to bus when enable.

Ventilation controller: support auto control, it is linkage control with PM2.5/CO2/VOC. And support the output types of 1bit of 1byte.

Logic function

Up to support 8 channels of logic, each channel up to support 8 inputs and 1 logic result.

Logic function support functions, including AND, OR, XOR, Gate forwarding, Threshold comparator, Format convert, Gate function, Delay function and Staircase lighting.

Scene group function

Up to support 8 channels of scene group forward, each group up to support 8 configurable output, datatype is optional 1bit/1byte/2byte.

Chapter 5 Parameter setting description in the ETS

5.1. KNX Secure

KNX Smart Touch with push button&Secure,3-gang is a KNX device that complies with the KNX secure standard. That is, you can run the device in safe way.



Fig.5.1 (1) "KNX Secure" parameter window

The device with KNX secure will be displayed notes on ETS, as shown as Fig.5.1(1).

If secure commissioning is activated in ETS project, the following information must be considered during device debugging:



- ❖ It is essential to assign a project password as soon as a KNX Secure device is imported into a project. This will protect the project against unauthorized access.

The password must be kept in a safe place – access to the project is not possible without it (not even the KNX Association or device manufacturer will be able to access it)!

Without the project password, the commissioning key will not be able to be imported.

- ❖ A commissioning key is required when commissioning a KNX Secure device (first download). This key (FDSK = Factory Default Setup Key) is included on a sticker on the side of the device, and it must be imported into the ETS prior to the first download:

- ❖ On the first download of the device, a window pops up in the ETS to prompt the user to enter the key, as shown in Fig.5.1 (2) below.

The certificate can also be read from the device using a QR scanner (recommended).

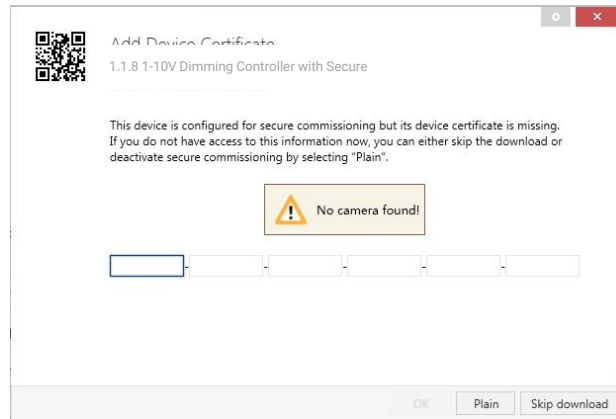

Fig.5.1(2) Add Device Certificate window

✧ Alternatively, the certificates of all Secure devices can be entered in the ETS beforehand.

This is done on the "Security" tab on the project overview page, as shown in Fig.5.1(3) below.

The certificates can be also added to the selected device in the project, as shown in Fig.5.1(4).

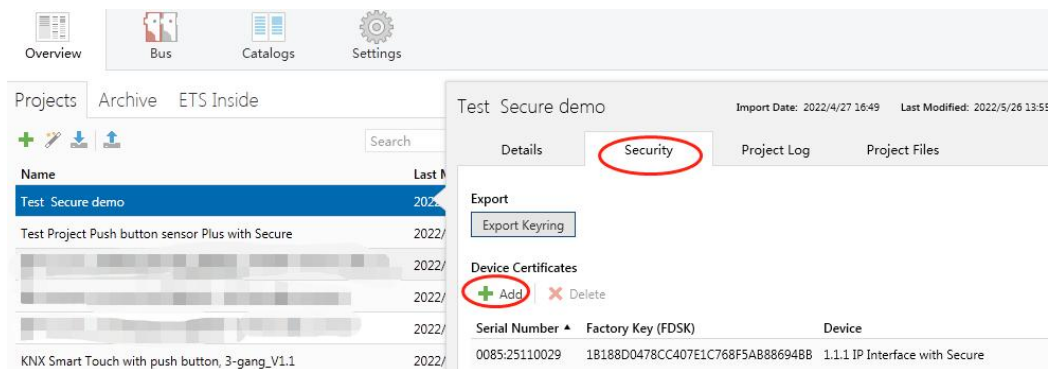

Fig.5.1(3) Add Device Certificate

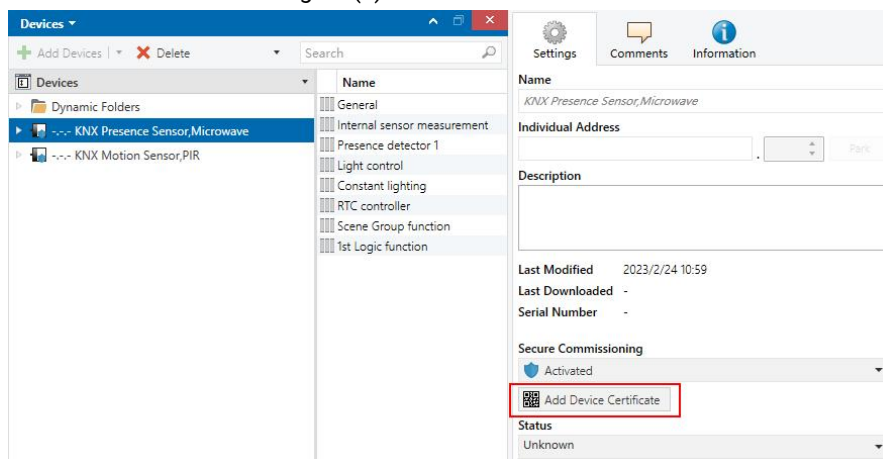

Fig.5.1(4) Add Device Certificate

✧ There is a FDSK sticker on the device, which is used for viewing FDSK number.

Without the FDSK, it will no longer be possible to operate the device in KNX Secure mode after a reset.

The FDSK is required only for initial commissioning. After entering the initial FDSK, the ETS will assign a new key, as shown in Fig.5.1(5) below.

The FDSK will be required again only if the device was reset to its factory settings (e.g. If the device is to be used in a different ETS project).

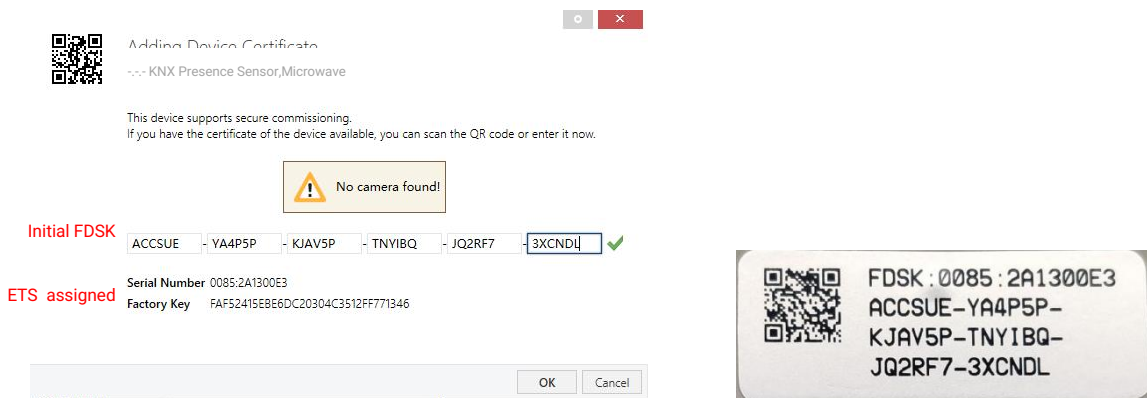

Fig.5.1(5)

Example:

If this application in the project needs to be tried with another device, it is no longer the original device. When the application is downloaded to a new device, the following prompt will appear on the left of Fig.5.1(6), click yes, the Add Device Certificate window will appear, then enter the initial FDSK of the new device, and you need to reset the device to the factory settings (it is not required if the device is still factory default; If it has been used, it will be required to reset, otherwise the following error message will appear on the right of Fig.5.1(6)), and then the device can be successfully downloaded again.

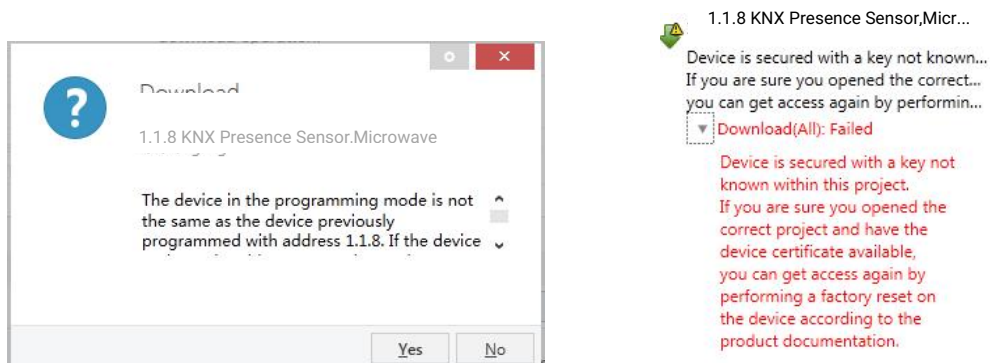

Fig.5.1(6) Example

Whether the device is replaced in the same project, or the device is replaced in a different project, the processing is similar: **Reset the device to the factory settings, then reassign the FDSK.**

After the device is downloaded successfully, the label Add Device Certificate turns gray, indicating that the key for this device has been assigned successfully, as shown in Fig.5.1(7) below.

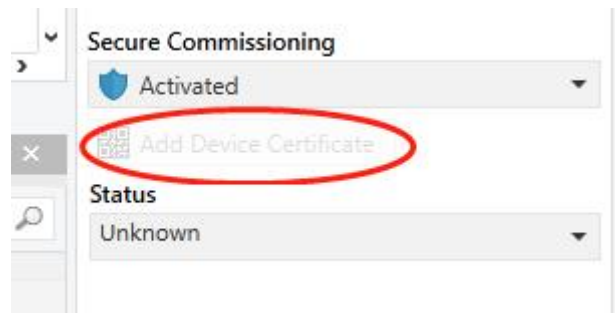

Fig.5.1(7)

ETS generates and manages keys:

Keys and passwords can be exported as needed to the use of security keys outside of the associated ETS projects. As shown in Fig.5.1(8) below, the file extension is .knxkeys.

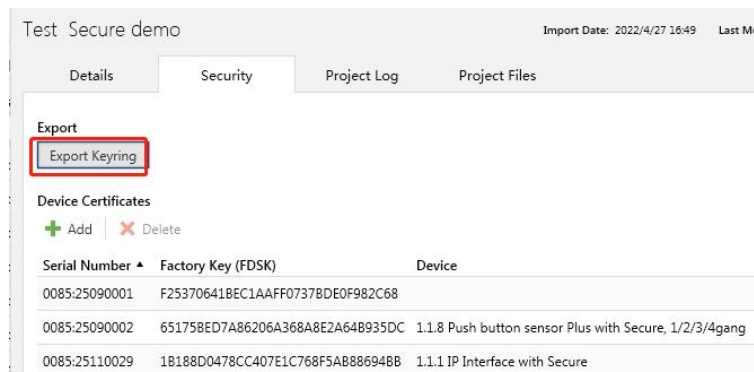

Fig.5.1(8)

Note: Any USB interface used for programming a KNX Secure device must support "long frames".

Otherwise ETS will report a download failure information, as shown below.

5.2.Parameter window “General”

5.2.1.Parameter window “General setting”

The screenshot displays the 'General setting' parameter window for a KNX Smart Touch with push button&Secure,3-gang device. The window is organized into several sections:

- General setting:**
 - Send delay after voltage recovery [0..15]: 5 s
 - Send cycle of In operation telegram [1..240,0=inactive]: 0 s
 - Delay time for exiting setting status: 3.0 s
 - Long operation for touch after: 0.5 s
- Screen display setting:**
 - Temperature display units: Celsius(°C) Fahrenheit(°F)
 - Interface Language: English
- Note:** The codepage option in the property of project must select the Unicode(UTF-8)
- UI theme is:** Dark style Light style
- Date display format:** yyyy/mm/dd dd/mm/yyyy
- Extension function:**
 - Screen saver:
 - Night mode:
 - Proximity function:
 - Alarm function:
- Brightness setting:**
 - Screen brightness in normal mode: 80 %
 - Screen brightness in night mode: 30 %
 - Status LED brightness in normal mode: 50 %
 - Status LED brightness in night mode: 5 %
 - Delay time for turn off LED&screen [0...255,0=inactive]: 20 s

Fig.5.2.1 “General setting” parameter window

Parameter “Send delay after voltage recovery [0..15]s”

This parameter is for setting the delay time to send to bus after the device voltage recovery.

Options: **0..15**

The setting dose not contain the device initialization time, and bus telegrams received during delay time will be recorded.

Parameter "Send cycle of In operation telegram [1..240,0=inactive]s"

This parameter is for setting the time interval when this device cycle send telegrams through the bus to indicate this module in normal operation. When set to "0", the object "in operation" will not send a telegram. If the setting is not "0", the object "In operation" will send a telegram according to the set period time with logic "1" to the bus. Options: **0...240s, 0= inactive**

As to reduce the bus load as much as possible, the maximum time interval should be selected according to actual needs.

Parameter "Delay time for exiting setting status"

This parameter is for setting the delay time to auto-exit setting status, mainly used for the sub function settings of RTC, Air-condition and Audio control. Telegrams are sent immediately, such as setpoint temperature, specific definition is according to the UI. Options:

0.5s

1.0s

2.0s

3.0s

Parameter "Long operation for touch after"

This parameter is for setting the trigger time of the long operation for touch on the screen. Options:

0.5s

1.0s

2.0s

3.0s

Screen display setting

Parameter "Temperature display units"

This parameter is for setting display units of temperature, optional Celsius and Fahrenheit.

Options:

Celsius(°C)

Fahrenheit(°F)

Parameter "Interface Language"

This parameter is for setting interface language of screen. Options:

Chinese(Simplified)	Spanish
Chinese(Traditional)	Russian
English	Italian
German	Greek
French	Other

Display the note when select non-Chinese:

Note:The codepage option in the property of project must select the Unicode(UTF-8)

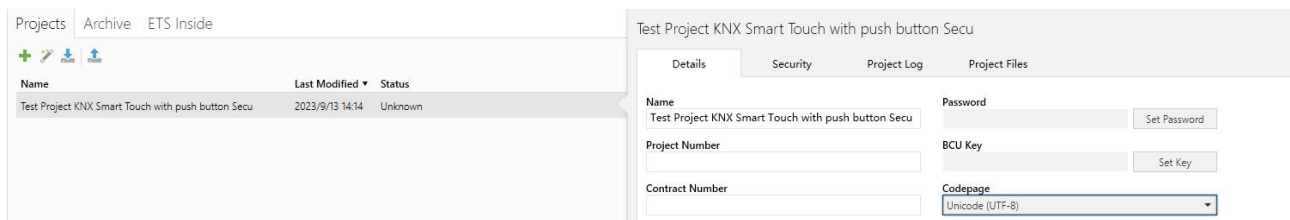

——Parameter "Language name"

This parameter is visible when interface language is selected "Other", used for input language name. The device will search for the corresponding language in the library according to the name and display it. When no corresponding language is searched, there will be displayed English by default. **Note:**

Please contact the manufacture for the support and input the information.

Parameter "UI theme is"

This parameter is for setting interface colour style of screen. Options:

Dark style

Light style

Parameter "Date display format"

This parameter is for setting date display style of screen. Options:

yyyy/mm/dd

dd/mm/yyyy

Extension function

Parameter "Screen saver"

Setting interface of screen saver will be visible when the parameter enabled.

Parameter "Night mode"

Setting interface of night mode will be visible when the parameter enabled.

Parameter "Proximity function"

Setting interface of proximity function will be visible when the parameter enabled.

Parameter "Alarm function"

Setting interface of alarm function will be visible when the parameter enabled.

Brightness setting

Parameter "Screen brightness in normal mode"

This parameter is for setting the screen brightness level when normal or day mode (some one proximity/operation). Options:

10%

20%

...

100%

Parameter "Screen brightness in night mode"

This parameter is visible when night mode enabled. Set the the screen brightness level when night mode (some one proximity/operation). Options:

10%

20%

...

100%

Unchanged

When normal/night mode, you can change the brightness via the object "Screen brightness" or the screen setting, it is not saved when voltage failure, and is restored to the parameter setting value after voltage recovery.

When night mode is selected "Unchanged", keep the brightness in normal mode, and at this time, you can not change the brightness via the object "Screen brightness" or the screen setting.

Parameter "Status LED brightness in normal mode"

This parameter is for setting the indicated LED brightness level with on the button panel when normal or day mode (some one proximity/operation). Options:

- 0%
- 5%
- 10%
- 20%
- ...
- 70%

Parameter "Status LED brightness in night mode"

This parameter is visible when night mode enabled. Set the indicated LED brightness level with on the button panel when night mode (some one proximity/operation). Options:

- 0%
- 5%
- 10%
- 20%
- ...
- 70%

Parameter "Delay time for turn off LED&screen {0...255,0=inactive}s"

This parameter is for setting the delay time that off screen and indication LED of button panel after no operation or enter screen saver. When the value is 0, it will not turn off the screen and the indication LED of button panel automatically.

Options: **0...255,0=inactive**

When set to 0, the following warning is prompted:

 Note: It is only recommend that this option is used for demonstration purpose,screen may be damaged when permanent on for long time

Parameter "Screen on/off function"

This parameter is visible when previous parameter value is 0. Control on/off screen via the 1bit object "Screen on/off" when not enable delay time for turn off screen function, and also set whether to control LED on/off status at the same time. When open the LED indication, according to the current

status to indicate. Options:

- Only apply to screen**
- Apply to Both Screen and Status LED**

5.2.2.Parameter window “Screen saver setting”

--- KNX Smart Touch with push button&Secure,3-gang > General > Screen saver setting

<ul style="list-style-type: none"> KNX Secure General General setting Screen saver setting Security setting Night mode setting Summer time setting Proximity setting Alarm setting Advanced setting Home page Function page setting Internal temperature meas... Button 	Screen saver display	<input type="text" value="Digital clock with air quality"/>
	Interface preview	
	Screen brightness in screen saver	<input type="text" value="50"/> %
	Delay time for normal to screen saver [5..255]	<input type="text" value="10"/> s
	Items 1 display function	<input type="text" value="Int. temperature"/>
	Function icon	50-Temperature 1
	Items 2 display function	<input type="text" value="Int. humidity"/>
	Function icon	52-Humidity
	Items 3 display function	<input type="text" value="None"/>

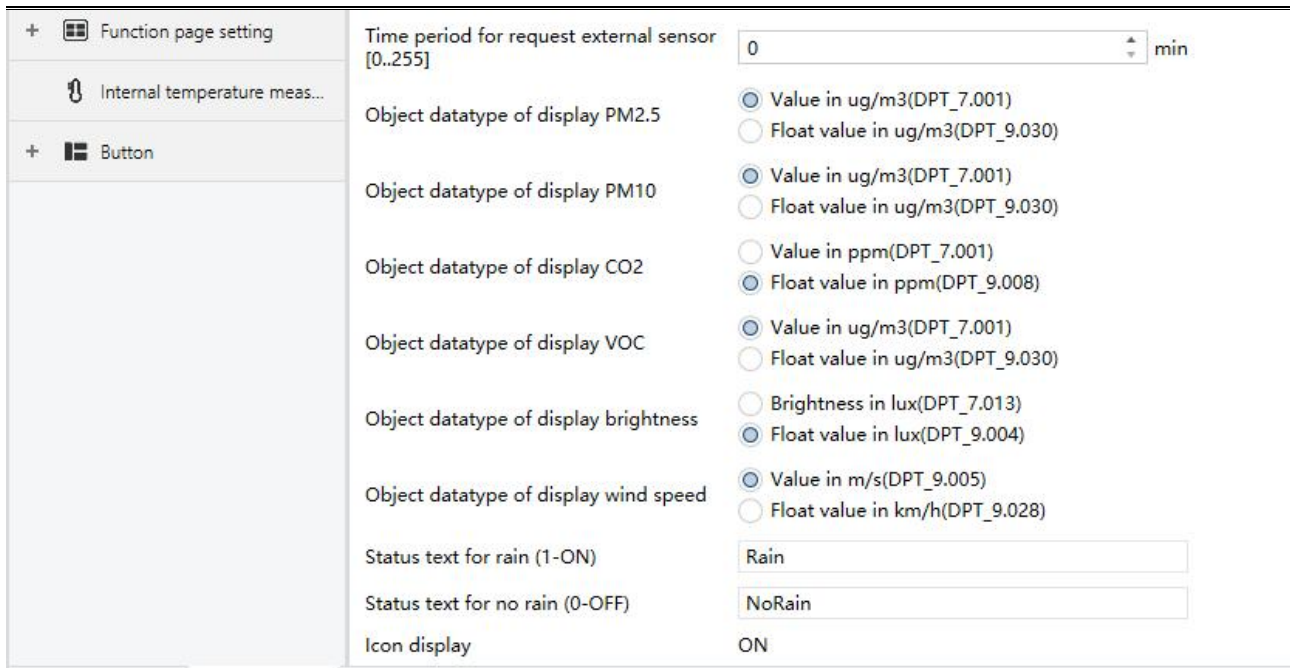

Fig.5.2.2 "Screen saver setting" parameter window

Parameter "Screen saver display"

This parameter is for setting the display style of screen saver. Below the parameter, display the interface interview according to the options:

Clock

Digital clock with air quality

Album(3 pictures)

Album(1 pictures)

Clock: Screen displays clock when enter the screen saver.

Digital clock with air quality: Screen displays digital clock with air quality when enter the screen saver.

Album(...): Screen displays pictures of the program when enter the screen saver, optional number of pictures. When select 3 pictures, switching in every 5 seconds.

Note: When album(...) is selected, screen-saver picture of the program can be replaced through USB. Details refer to the appendix.

Parameter "Screen brightness in screen saver"

This parameter is for setting screen brightness level in screen saver. Options:

10%

20%

...

50%

Parameter "Delay time for normal to screen saver [5..255]s"

This parameter is for setting the delay time for normal mode to screen saver. Options: **5..255**

Parameters as follow are visible when "Digital clock with air quality" is selected:

Parameter "Items x display function" (x=1~4)

This parameter is for setting the air quality information displayed in screen saver, up to 4 items.

Options:

None	VOC
Int. temperature	CO2
Int. humidity	AQI
Ext. temperature	Brightness
Ext. humidity	Wind speed
PM2.5	Rain
PM10	

Parameters as follow are not visible when "None" is selected.

Parameter "Function icon"

This parameter is for setting the icon for air quality information using. Options:

01-General light

02-Ceiling light

...

80-Floor light

The default icons corresponding to the function and the icons corresponding to the options are

described in the appendix.

Parameter "Time period for request external sensor [0..255]min"

This parameter is for setting the time period for device to send a control value read request to external sensor after bus recovery or finish programming. Not send when value is 0. Options: **0..255**

Parameter "Object datatype of display PM2.5/PM10/VOC"

This parameter is for setting the object datatype of display PM2.5/PM10/VOC. Options:

Value in ug/m3(DPT_7.001)

Float value in ug/m3(DPT_9.030)

Parameter "Object datatype of display CO2"

This parameter is for setting the object datatype of display CO2. Options:

Value in ppm(DPT_7.001)

Float value in ppm(DPT_9.008)

Parameter "Object datatype of display brightness"

This parameter is for setting the object datatype of display brightness. Options:

Brightness in lux(DPT_7.013)

Float value in lux(DPT_9.004)

Parameter "Object datatype of display wind speed"

This parameter is for setting the object datatype of display wind speed. Options:

Value in m/s(DPT_9.005)

Float value in km/h(DPT_9.028)

Parameter "Status text for rain (1-ON)"

Parameter "Status text for no rain (0-OFF)"

This parameter is for setting the status text for rain and no rain, and display the dynamic icon at the same time.

Parameter "Icon display"

This parameter is for setting the indication status of the icon on the screen. Default read-only **ON**

5.2.3.Parameter window “Security setting”

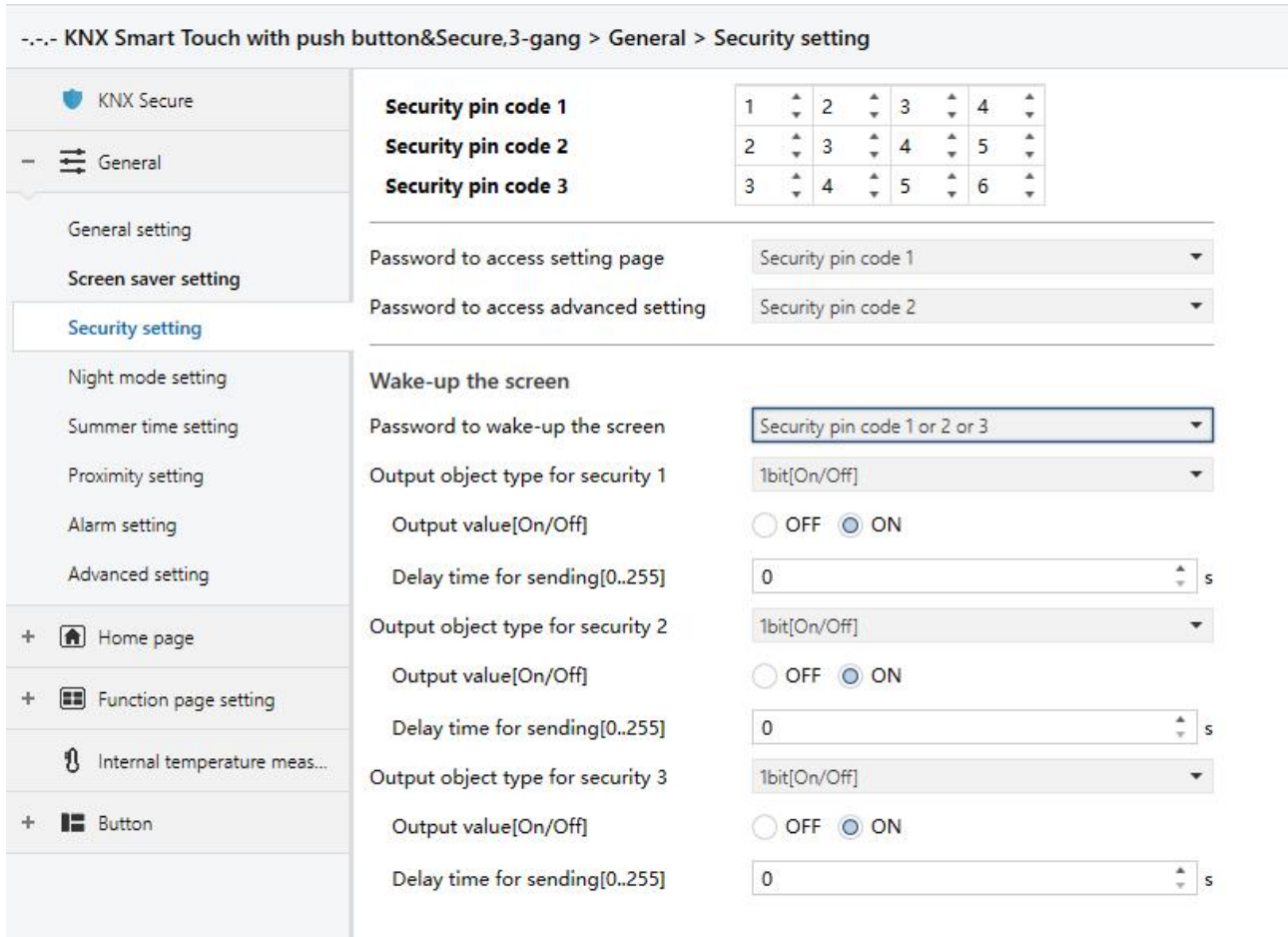

Fig.5.2.3 “Security setting” parameter window

Parameter “Security pin code x”(x=1~3)

These parameters are for setting security password. Up to support 3 passwords, used for activating other functions (Screen saver and advanced setting).

Each password is defined by a separate 4 bytes, range of each byte: **0..9**

Parameter “Password to access setting page”

This parameter is for setting password to access setting page. Options:

- None
- Security pin code 1
- Security pin code 2
- Security pin code 3

Parameter "Password to access advanced setting"

This parameter is for setting password to access advanced setting. Options:

- None
- Security pin code 1
- Security pin code 2
- Security pin code 3

Wake-up the screen setting

Parameter "Password to wake-up the screen"

This parameter is for setting whether the password is required when the screen wakes up from the screen saver or screen off status. If required, set a or multiple passwords as reference. **Note: When multiple passwords are set to the same, only response previous one output setting.**

Options:

- None
- Security pin code 1
- Security pin code 2
- Security pin code 3
- Security pin code 1 or 2
- Security pin code 1 or 3
- Security pin code 2 or 3
- Security pin code 1 or 2 or 3

These three parameters as follow display one or multiple password settings according to previous parameter:

—Parameter "Output object type for security x"(x=1~3)

This parameter is for setting whether to send telegrams to bus when user inputs security password

x. Options:

No reaction

1bit[On/Off]

1byte[scene control]

1byte[0..255]

1byte[0..100%]

—Parameter “Output value...”

This parameter is for setting the specific sent telegram value according to previous parameter.

Options: **OFF/ON / Scene No.1..Scene No.64 / 0..255 / 0..100%**

—Parameter “Delay time for sending[0..255]s”

This parameter is visible when “No reaction” is not selected. Set the delay time for sending value.

Options: **0..255**

5.2.4.Parameter window “Night mode setting”

The screenshot shows the 'Night mode setting' window for a KNX Smart Touch device. The breadcrumb path is: KNX Smart Touch with push button&Secure,3-gang > General > Night mode setting. On the left, there is a sidebar with 'KNX Secure' (shield icon), 'General' (hamburger icon), 'General setting', 'Screen saver setting', and 'Security setting'. The main area contains three settings: 'Polarity of normal/night mode' with radio buttons for 'Normal=1/Night=0' and 'Normal=0/Night=1' (the latter is selected); 'Switchover normal/night mode' with a dropdown menu set to 'Via object'; and 'Normal/night mode need send read request after voltage recovery' with radio buttons for 'No' and 'Yes' (the latter is selected). A blue information box at the bottom states: 'Note: Default to normal mode if no response when request after startup'.

Via object

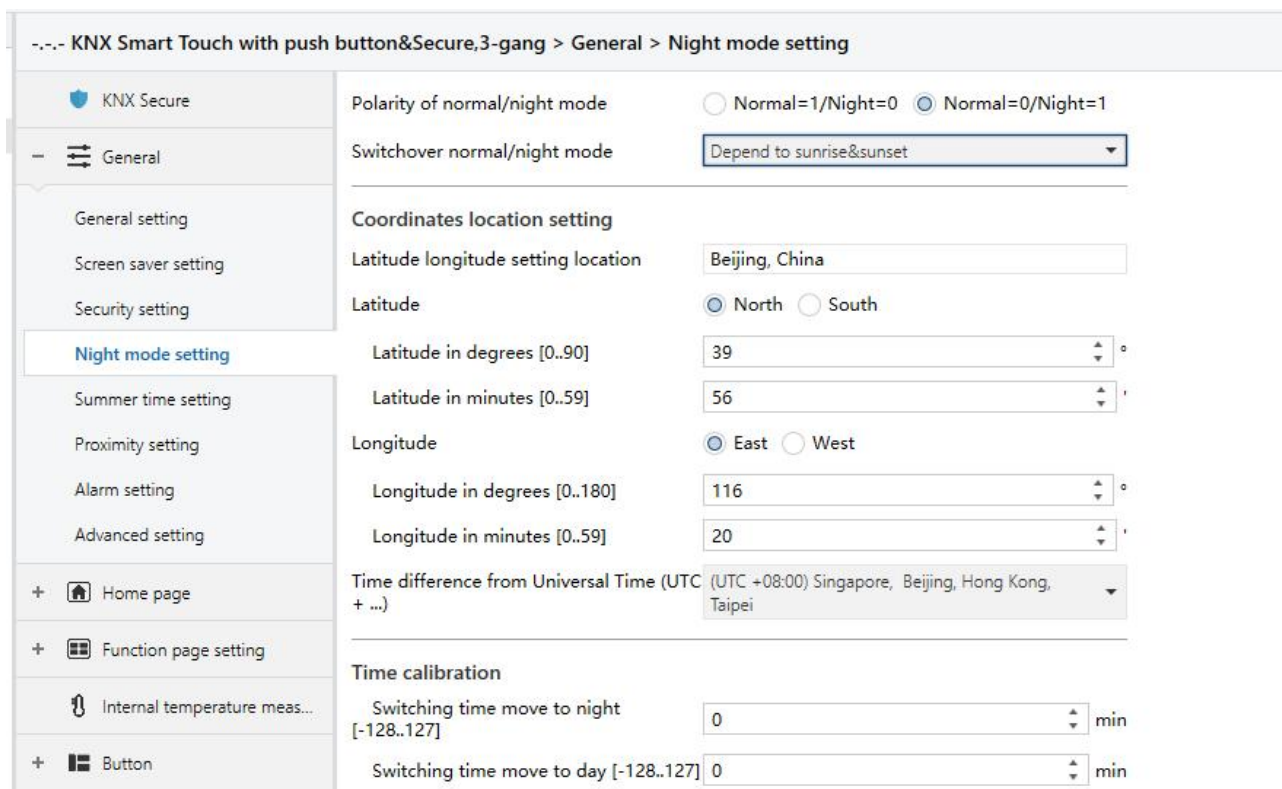
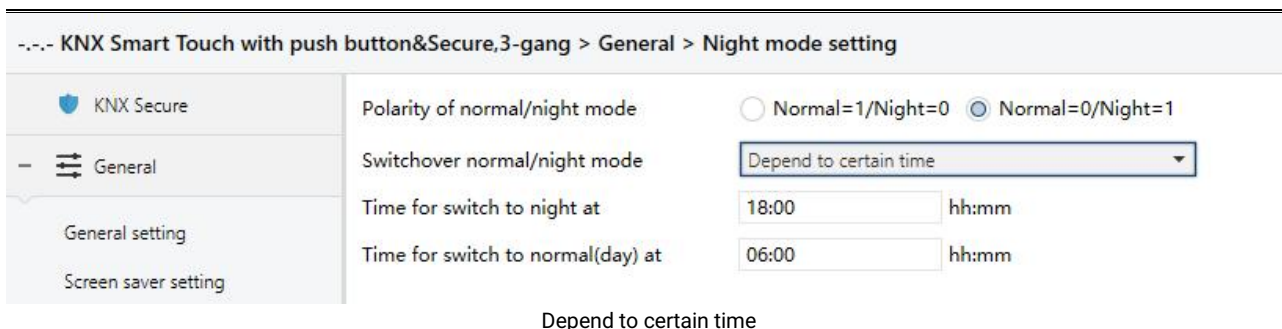

Fig.5.2.4 "Screen saver setting" parameter window

Parameter "Polarity of normal/night mode"

This parameter for setting object value of normal/night mode. Options:

Normal=1/Night=0

Normal=0/Night=1

Parameter "Switchover normal/night mode"

This parameter for setting the switchover way of normal/night status, send status telegrams via

object "Night mode" when status change. Options:

Via object

Depend to certain time

Depend to sunrise&sunset

Via object: Only switch status via object. Default to normal mode after voltage recovery.

Depend to certain time: Switch the normal/night status based on the specific time. Such as switch 18:30P.M. to the night status, 6:30A.M. to the normal status.

Depend to sunrise&sunset: Switch the normal/night status based on the sunrise and sunset. The coordinate position of the reference point of sunrise and sunset, such as Beijing, China, needs to be defined, with the center located at east longitude 160°20'and north latitude 39°56'.

When "Via object" is selected, the following parameter is visible, for setting the object via bus to switch to the night or to the normal.

—Parameter "Normal/night mode need send read request after voltage recovery"

This parameter for setting whether the object "Night mode" to send read request when bus recovery or finish programming. If send the read request, LED indicates according to setting brightness of responded normal/night mode. Options:

No

Yes

 Note: Default to normal mode if no response when request after startup

When "Depend to certain time" is selected, the following 2 parameters are visible, for setting the time to switch to the night or to the normal.

—Parameter "Time for switch to night at"

This parameter for setting the time point to switch to the night status, accurate to minutes.

Options: **00:00-23:59**

—Parameter "Time for switch to normal(day) at"

This parameter for setting the time point to switch to the normal status, accurate to minutes.

Options: **00:00-23:59**

When “Depend to sunrise&sunset” is selected, the following parameters are visible, for setting the coordinate position of the reference point of sunrise and sunset.

Coordinates location setting

—Parameter “Latitude longitude setting location”

Setting the reference point of sunrise and sunset, such as “Beijing, China”.

—Parameter “Latitude”

Setting whether the reference point of sunrise and sunset is located at south latitude or north latitude. Options:

North

South

—Parameter “Latitude in degrees [0°..90°]”

—Parameter “Latitude in minutes [0'..59']”

These two parameters for setting latitude, such as Beijing located at north latitude 39°56'.

—Parameter “Longitude”

Setting whether the base point of sunrise and sunset is located at east longitude or west longitude.

Options:

East

West

—Parameter “Longitude in degrees [0°..180°]”

—Parameter “Longitude in minutes [0'..59']”

These two parameters for setting longitude, such as Beijing located at east longitude 116°20'.

—Parameter “Time difference from Universal Time (UTC + ...)”

This parameter for setting the time difference from Universal Time. Options:

(UTC -12: 00) International Date Line West

(UTC -11: 00) Samoa

.....

(UTC +11: 00) Magadan, Salomon Islands, New Caledonia

(UTC +12: 00) Aukland, Wellington, Fiji

Time calibration

—Parameter “Switching time move to night [-128..127]min”

This parameter for setting the delay time to switch to the night status after reaching to the time point of sunset. Options:-128..127

—Parameter “Switching time move to day [-128..127]min”

This parameter for setting the delay time to switch to the day status after reaching to the time point of sunrise. Options:-128..127

For example, if setting -10min, it will switch to day status 10min earlier before the sunrise; if setting 10min, it will switch to day status 10min later after the sunrise.

Note: if summer time is set, then sunrise and sunset time will automatically adjust according to time interval of summer time. Details refer to section 5.1.5.

5.2.5.Parameter window “Summer time setting”



Fig.5.2.5 “Summer time setting” parameter window

Parameter “Changeover of summer time”

This parameter for setting the summer time. Options:

No active

Always

Customized

No active: Disable summer time.

Always: always enable summer time.

Customized setting: For customized setting the start/end time of summer time.

When “Customized ” is selected, the following four parameters are visible, for setting the start and end time of summer time.

—Parameter “Start at month”

—Parameter “End at month”

These parameters for setting summer time start or end at month.Options:

January

February

...

December

—Parameter “Start at week”

—Parameter “End at week”

These parameters for setting summer time start or end at week. Options:

The first week

The second week

...

The last week

—Parameter “Start at day”

—Parameter “End at day”

These parameters for setting summer time start or end at day. Options:

Monday

Tuesday

...

Sunday

—Parameter “Start at hour: minute”

—Parameter “End at hour: minute”

These parameters for setting summer time start or end time, accurate to minutes. Options:

00:00-23:59

5.2.6.Parameter window “Proximity setting”

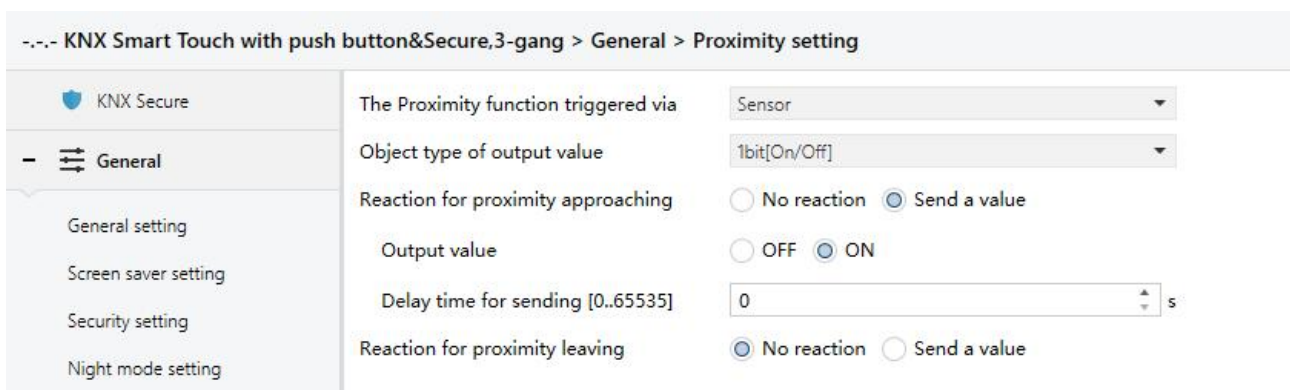

Fig.5.2.6 “Proximity setting” parameter window

Parameter “The Proximity function triggered via”

This parameter is for setting the trigger way of proximity function. Options:

Sensor

Proximity object

Sensor or Proximity object

When “Sensor or Proximity object” is selected, not send output value when proximity triggered via object.

Parameters as follow are visible when “Sensor” or “Sensor or Proximity object” is selected.

Parameter “Object type of output value”

This parameter is for setting the object type of output value to the bus when proximity approaching or leaving. Options:

1bit[On/Off]

1byte[scene control]

1byte[0..255]

1byte[0..100%]

Parameter "Reaction for proximity approaching"

Parameter "Reaction for proximity leaving"

These parameters are setting whether to send telegram when proximity approaching or leaving.

Options:

No reaction

Send a value

—Parameter "Output value"

This parameter is visible when "Send a value" is selected. Set the output value sending to the bus when proximity approaching or leaving, the range of value is determined by the data type.

—Parameter "Delay time for sending [0..65535]s"

This parameter is visible when "Send a value" is selected. Set the delay time for sending telegram.

When proximity approaching, Options: **0..65535**

When proximity leaving, Options: **5..65535**

Note: If telegram of proximity leaving need to be sent during the delay time of proximity approaching, then ignore the telegram of proximity approaching, telegram send once when status of proximity approaching has changed.

5.2.7.Parameter window "Alarm setting"

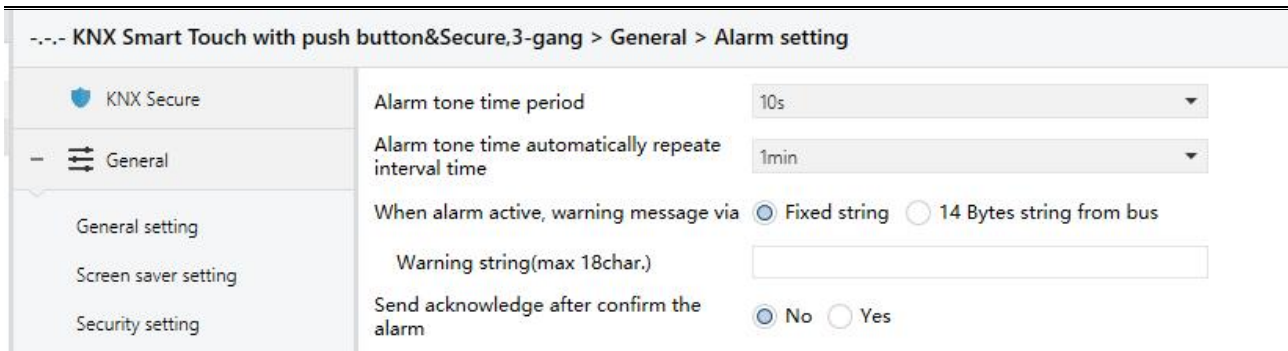

Fig.5.2.7 “Alarm setting” parameter window

Parameter “Alarm tone time period”

This parameter is for setting the time period of alarm tone. When receive the alarm telegram, play alarm tone immediately, if currently playing and it will not be interrupted and will not be re-timed. If receive the cancel alarm telegram when playing, it will be interrupted immediately. Options:

Disable

10s

20s

...

25min

30min

Disable: disable the alarm tone playing function;

Other options: the playing period of alarm tone.

Parameter “Alarm tone time automatically repeate interval time”

This parameter is visible when previous parameter is enabled. Set the interval at which alarm tone time automatically repeat, and the timing is only related to when the last play ended. Options:

Disable

10s

20s

...

25min

30min

Disable: disable the alarm tone repeate function;

Other options: when a playing period complete, it will automatically play again after a delay of the setting time.

Parameter "When alarm active, warning message via"

When alarm activated, this parameter is for setting input type of warning message, either by displaying a fixed string entered by ETS on the screen or by receiving a 14byte string from the bus.

Options:

Fixed string

14 Bytes string from bus

When it is selected "14 Bytes string from bus", display the information as follow:

 The encode data of telegram must be ISO8859 or ASCII characters

The encode data of alarm telegram is associated with interface language, when it is selected **Simplified Chinese, Traditional Chinese, Russian or Greek, use UTF-8; while other languages, use ISO8859.**

Parameter "Warning string(max 18char.)"

This parameter is visible when previous parameter is selected "Fixed string". Set the indicate text when alarm activated.

Parameter "Send acknowledge after confirm the alarm"

This parameter is for setting whether to send a 1bit acknowledge telegram, the action that only needs to be processed when the user clicks on the screen to acknowledge the warning message.

5.2.8.Parameter window "Advanced setting"

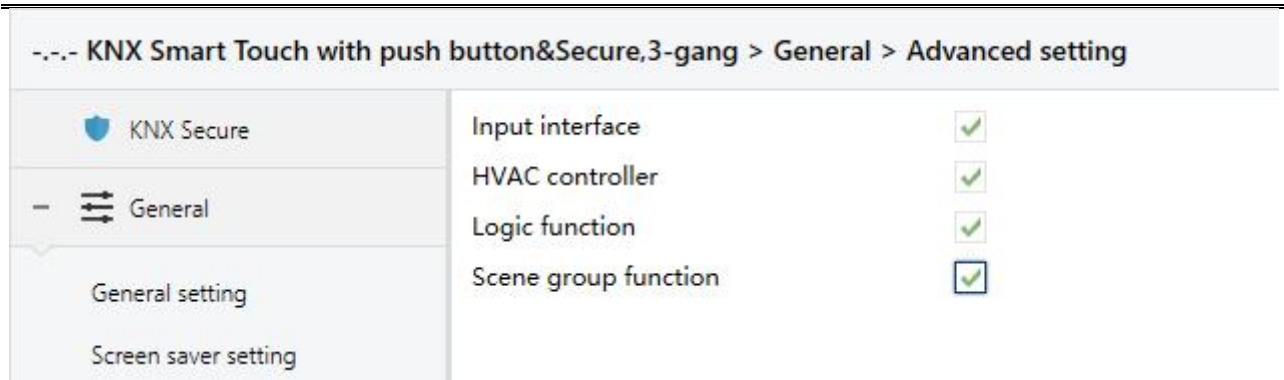

Fig.5.2.8 “Advanced setting” parameter window

Parameter “Input interface”

Setting page of input interface is visible after this parameter enabled.

Parameter “HVAC controller”

Setting page of HVAC controller is visible after this parameter enabled.

Parameter “Logic function”

Setting page of logic function is visible after this parameter enabled.

Parameter “Scene group function”

Setting page of scene group function is visible after this parameter enabled.

5.3.Parameter window “Internal temperature measurement”

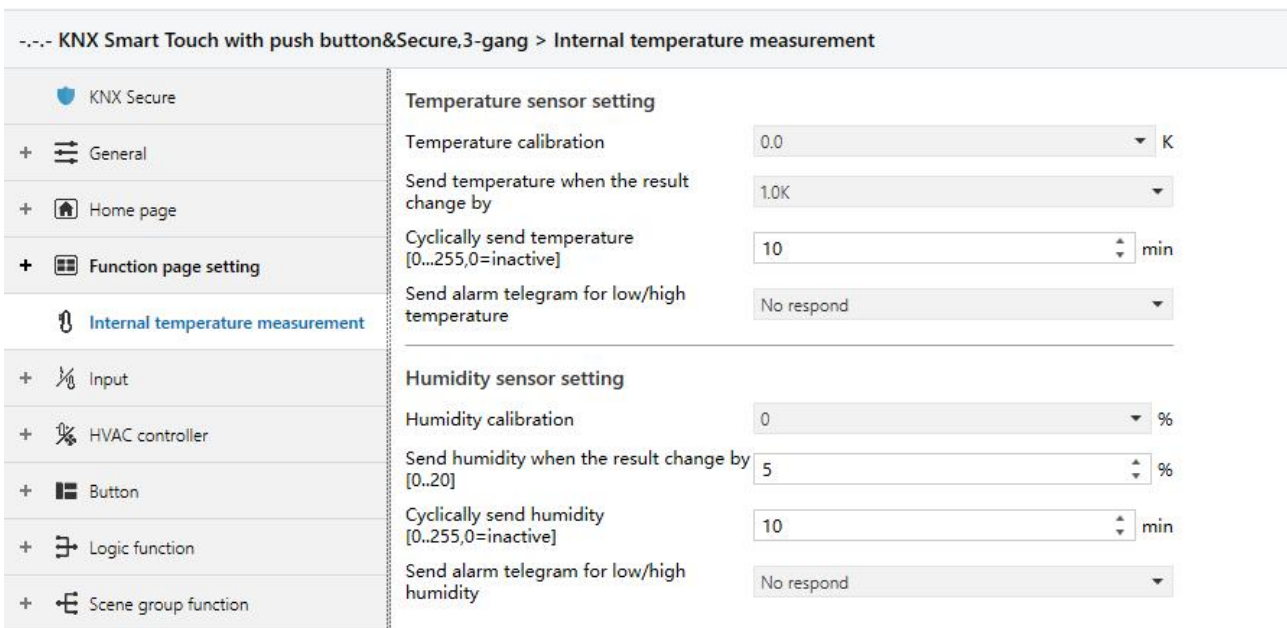

Fig.5.3 “Internal temperature measurement” parameter window

The following parameters is used for setting the calibration value, sending condition and error report of internal sensor. If internal sensor is selected for other functions as well, please refer to this

section.

Temperature sensor setting

Parameter "Temperature calibration"

This parameter is for setting the temperature calibration value of the internal sensor, that is, to calibrate the measured value of internal sensor to make it closer to the current ambient temperature.

Options:

-5K

...

0K

...

5K

Note: after the device is powered on, the stability time of internal sensor detection will take 30 minutes, therefore, the detected temperature value in the early stage of device work may be inaccurate.

Parameter "Send temperature when the result change by"

This parameter is for setting when temperature turns to a certain value, whether to enable to send the current temperature value to the bus. Not send when disable. Options:

Disable

0.5K

1.0K

...

10K

Parameter "Cyclically send temperature [0...255,0=inactive]min"

Setting the time for cyclically sending the temperature detection value to the bus. Options: **0..255**

This period is independent and starts time counting after programming completion or reset.

Transmission change has no affect on this period.

Parameter "Send alarm telegram for low/high temperature"

This parameter is for setting condition of sending telegram when low/high temperature alarm.

Options:

No respond

Respond after read only

Respond after change

Respond after read only: Only when the device receives a read alarm from other bus device or bus will the object "Low temperature alarm"/" High temperature alarm" send the alarm status to the bus;

Respond after change: the object " Low temperature alarm"/" High temperature alarm" will immediately send the telegram to the bus to report the alarm value when the alarm status has changed.

These two parameters as follow are visible when "Respond after read only" or "Respond after change" are selected.

—Parameter "Threshold value for low temperature alarm [0..15]°C"

This parameter is for setting the threshold value for low temperature alarm. When the temperature lower than low threshold, low temperature alarm object will send telegram. Options:

0°C

1°C

...

15°C

—Parameter "Threshold value for high temperature alarm [30..45]°C"

This parameter is for setting the threshold value for high temperature alarm. When the temperature higher than high threshold, high temperature alarm object will send telegram. Options:

30°C

31°C

...

45°C

Humidity sensor setting

Parameter "Humidity calibration"

This parameter is for setting the humidity calibration value of the internal sensor, that is, to calibrate the measured value of internal sensor to make it closer to the current ambient humidity.

Options: **-20% / -15% / -10% / -5% / -3% / -1% / 0% / 1% / 3% / 5% / 10% / 15% / 20%**

Parameter "Send humidity when the result change by [0..20]%"

This parameter is for setting when humidity turns to a certain value, whether to enable to send the current humidity value to the bus. Not send when value is 0. Options: **0..20**

Parameter "Cyclically send humidity [0..255,0=inactive]min"

Setting the time for cyclically sending the humidity detection value to the bus. Options: **0..255**

This period is independent and starts time counting after programming completion or reset.

Transmission change has no affect on this period.

Parameter "Send alarm telegram for low/high humidity"

This parameter is for setting condition of sending telegram when low/high humidity alarm.

Options:

No respond

Respond after read only

Respond after change

Respond after read only: Only when the device receives a read alarm from other bus device or bus will the object " Low humidity alarm"/" High humidity alarm" send the alarm status to the bus;

Respond after change: the object " Low humidity alarm"/" High humidity alarm" will immediately send the telegram to the bus to report the alarm value when the alarm status has changed.

These two parameters as follow are visible when "Respond after read only" or "Respond after change" are selected.

—Parameter "Threshold value for low humidity alarm [5..20]%"

This parameter is for setting the threshold value for low humidity alarm. When the humidity lower than low threshold, low humidity alarm object will send telegram. Options: **5..20**

—Parameter "Threshold value for high humidity alarm [70..85]%"

This parameter is for setting the threshold value for high humidity alarm. When the humidity higher than high threshold, high humidity alarm object will send telegram. Options: **70..85**

5.4.Parameter window “Input”

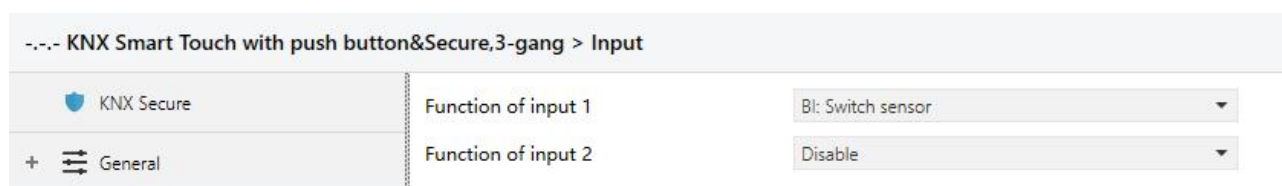

Fig.5.4 “Input” parameter window

Parameter “Function of input x” (x=1, 2)

This parameter is for setting the function of external input interface. Support temperature detection and dry contact input (BI), setting page will be visible when select corresponding chosen.

Also can be disable this channel function. Options:

Disable

Temperature probe(NTC 10K)

BI: Switch sensor

BI: Scene control

BI: Send String(14bytes)

When select Temperature probe(NTC 10K), can detect external temperature, which needs set B value of temperature probe.

When select dry contact input (BI), only supports the basic functions, including switch, scene send strings (press/release, short/long, send after voltage recovery, disable function).

Chapters as follow explain the functions of external input interface separately.

5.4.1. Temperature probe

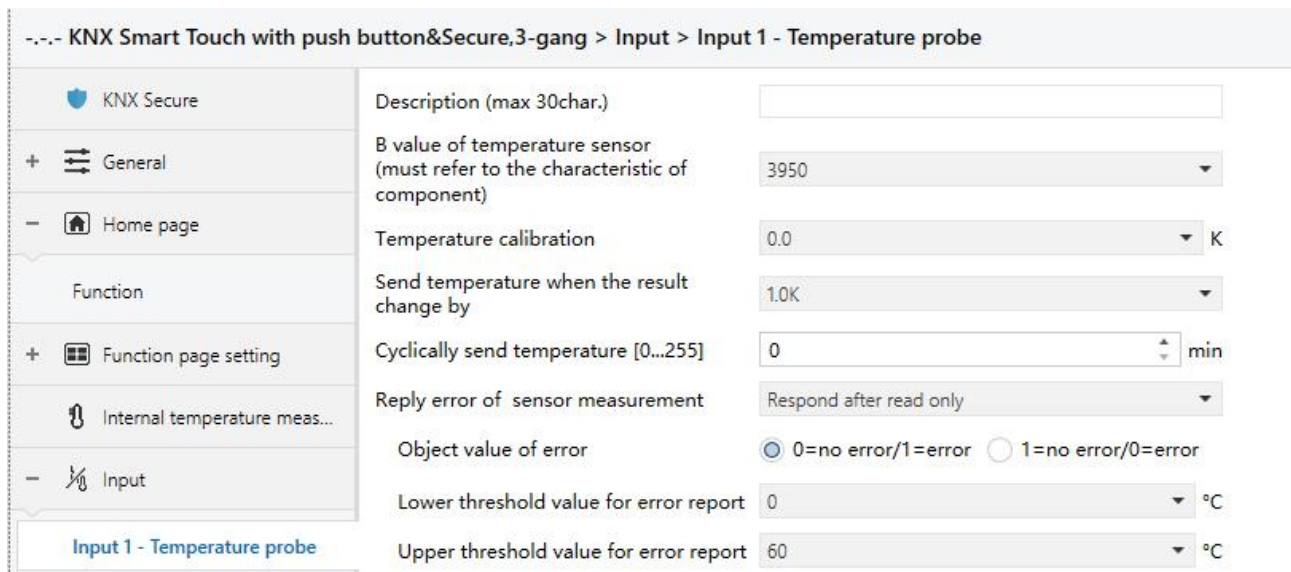

Fig.5.4.1 Parameter setting of temperature probe

Parameter "Description (max 30char.)"

This parameter is for setting the name description of temperature probe.

Parameter "B value of temperature sensor(must refer to the characteristic of component)"

This parameter is for setting the B value of temperature sensor. Options:

3275

3380

...

4200

Note: This value must refer to the characteristic of component, available from the instruction manual. If selected B value is different from used sensor, it will effect detection result directly.

Parameter "Temperature calibration"

This parameter is for setting the temperature calibration value of the temperature sensor, that is, to

calibrate the measured value of sensor to make it closer to the current ambient temperature. Options:

-5K

...

0K

...

5K

Parameter "Send temperature when the result change by"

This parameter is for setting when temperature turns to a certain value, whether to enable to send the current temperature value to the bus. Not send when disable. Options:

Disable

0.5K

1.0K

...

10K

Parameter "Cyclically send temperature [0..255,0=inactive]min"

Setting the time for cyclically sending the temperature detection value to the bus. Not send when value is 0.

Options: **0..255**

Parameter "Reply error of sensor measurement"

This parameter for setting the condition of sending error status report when temperature exceeds the valid detection. options:

No respond

Respond after read only

Respond after change

Respond after read only: Only when the device receives a read error from other bus device or bus will the object " Temperature error report, Sensor" send the error status to the bus;

Respond after change: The object " Temperature error report, Sensor" will immediately send the telegram to the bus to report the error value when the error status has changed.

These three parameters as follow are visible when “Respond after read only” or “Respond after change” are selected.

—**Parameter “Object value of error”**

This parameter for defining object value of error. Options:

0=no error/1=error

1=no error/0=error

0=no error/1=error: The object value for which sensor no error occurs is 0, and the object value for which sensor error occurs is 1;

1=no error/0=error: It has the opposite meaning.

—**Parameter “Lower threshold value for error report”**

This parameter is for setting the lower threshold value for temperature error. When the temperature lower than the threshold, temperature error object will send telegram.

Options: **10°C / 5°C / 0°C / -5°C / -10°C / -20°C**

—**Parameter “Upper threshold value for error report”**

This parameter is for setting the upper threshold value for temperature error. When the temperature higher than the threshold, temperature error object will send telegram.

Options: **40°C / 45°C / 50°C / 55°C / 60°C / 70°C**

5.4.2.Binary input

--- KNX Smart Touch with push button&Secure,3-gang > Input > Input 1 - Switch sensor

<ul style="list-style-type: none"> KNX Secure General Home page Function Function page setting Internal temperature measurement 	Description (max 30char.) <input type="text"/> Distinction between short and long operation <input checked="" type="radio"/> No <input type="radio"/> Yes Reaction on close the contact ON Reaction on open the contact OFF Send object value after voltage recovery (valid if reaction is not toggle) <input checked="" type="radio"/> No <input type="radio"/> Yes Number of objects <input checked="" type="radio"/> 1 <input type="radio"/> 2 Disable function Disable
---	--

Fig.5.4.2(1) Parameter setting of switch sensor

--- KNX Smart Touch with push button&Secure,3-gang > Input > Input 1 - Scene control

<ul style="list-style-type: none"> KNX Secure General Home page Function Function page setting Internal temperature measurement Input Input 1 - Scene control 	Description (max 30char.) <input type="text"/> Distinction between short and long operation <input type="radio"/> No <input checked="" type="radio"/> Yes Long operation after [3..25] 5 *0.1s Connected contact type <input checked="" type="radio"/> Normally open <input type="radio"/> Normally closed Reaction on short operation Recall scene 8 bit scene number Scene No.1 Reaction on long operation Store scene 8 bit scene number Scene No.1 Number of objects <input checked="" type="radio"/> 1 <input type="radio"/> 2 Disable function Disable
---	---

Fig.5.3.2(2) Parameter setting of scene control

--- KNX Smart Touch with push button&Secure,3-gang > Input > Input 1 - Send String

<ul style="list-style-type: none"> KNX Secure General Home page Function Function page setting Internal temperature measurement 	Description (max 30char.) <input type="text"/> Distinction between short and long operation <input checked="" type="radio"/> No <input type="radio"/> Yes Reaction on close the contact <input type="radio"/> No reaction <input checked="" type="radio"/> Send Value String (14byte) value Hello, world ! Reaction on open the contact <input checked="" type="radio"/> No reaction <input type="radio"/> Send Value Send object value after voltage recovery <input checked="" type="radio"/> No <input type="radio"/> Yes Disable function Disable
---	---

Fig.5.4.2(3) Parameter setting of sending sting

Parameter "Description (max 30char.)"

This parameter is for setting the name description for binary input function.

Parameter "Distinction between short and long operation"

This parameter is for setting whether to distinction between short and long operation. Options:

No

Yes

—Parameter “Long operation after [3..25]*0.1s”

This parameter is visible when distinction between short and long operation. Set the effective time of long operation. When button operation out of the setting time, it is a long operation, otherwise it is a short operation.

Options: **3..25**

—Parameter “Connected contact type”

This parameter is visible when distinction between short and long operation. Set the connected contact type.

Options:

Normally open

Normally closed

When function is selected “BI: Switch sensor”, the following parameters are visible, for setting switch sensor.

—Parameter “Reaction on short/long operation”

This parameter is visible when distinction between short and long operation, performing the action according to the settings of the short and long operations. Set the switch value to send when button operation. Options:

No reaction

OFF

ON

TOGGLE

No action: No telegrams have been sent.

ON: Send the on telegram.

OFF: Send the off telegram.

TOGGLE: Each operation will switch between on and off.

—Parameter “Reaction on close/open the contact”

This parameter is visible when no distinction between short and long operation. Judge the close and open operations, and perform the actions according to the settings. Set the switch value to send when button operation. Options:

No reaction

OFF

ON

TOGGLE

—Parameter “Send object value after voltage recovery (valid if reaction is not toggle)”

This parameter is visible when no distinction between short and long operation. This parameter is valid if not select “TOGGLE” or “No reaction”, set whether to send object value after voltage recovery.

Options:

No

Yes

When function is selected “BI: Scene control”, the following parameters are visible, for setting scene control.

—Parameter “Reaction on short/long operation”

This parameter is visible when distinction between short and long operation, performing the action according to the settings of the short and long operations. Set the scene command to send when button operation. Options:

No reaction

Recall scene

Store scene

—Parameter “Reaction on close/open the contact”

This parameter is visible when no distinction between short and long operation. Judge the close and open operations, and send or storage scenes according to the settings. Set the scene command to send when button operation. Options:

No reaction

Recall scene

Store scene

—Parameter “8 bit scene number”

This parameter is visible when “Recall scene” or “Store scene” is selected. Set the scene number, range: **Scene NO.1~64, corresponding telegram is 0~63**

When function is selected “BI: Send String(14bytes)”, the following parameters are visible, for setting string sending.

—Parameter “Reaction on short/long operation”

This parameter is visible when distinction between short and long operation, performing the action according to the settings of the short and long operations. Options:

No reaction

Send Value

—Parameter “Reaction on close/open the contact”

This parameter is visible when no distinction between short and long operation. Judge the close and open operations, and send strings according to the settings. Options:

No reaction

Send Value

—Parameter “String (14byte) value”

This parameter is visible when “Send Value” is selected. Input the strings to send.

—Parameter “Send object value after voltage recovery”

This parameter is visible when no distinction between short and long operation. Set whether to send object value after voltage recovery. Options:

No

Yes

Parameter “Number of objects”

This parameter is visible when the parameter “Reaction on long/open operation” is not selected “No reaction”. Set whether to use a common object or two separate objects when open/close and

long/short operations. Options:

1

2

Parameter "Disable function"

This parameter is visible when binary input functions are selected. Set trigger value to disable/enable contacts. Options:

Disable

Disable=1/Enable=0

Disable=0/Enable=1

5.5.Parameter window "HVAC controller"

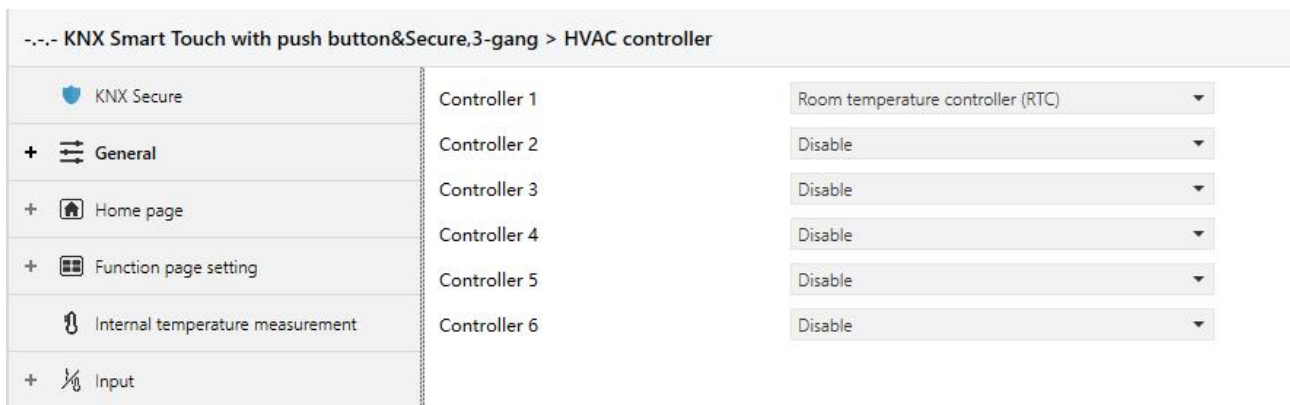

Fig.5.5 "HVAC controller" parameter window

Parameter "Controller 1/2/3/..."

This parameter is for setting whether to enable the setting interface of HVAC controller, display corresponding interface. Up to enable 6 independent controllers, used for linking to room temperature controller or ventilation controller. Options:

Disable

Room temperature controller (RTC)

Ventilation controller

Chapters as follow explain the functions of room temperature controller (RTC) and ventilation controller separately.

5.5.1.Parameter window “Controller x - RTC”(x=1~6)

--- KNX Smart Touch with push button&Secure,3-gang > HVAC controller > Controller 1 - RTC

<ul style="list-style-type: none"> KNX Secure + General + Home page + Function page setting Internal temperature measurement + Input - HVAC controller + Controller 1 - RTC + Button + Logic function + Scene group function 	<p>Description (max 30char.)</p> <p>Room temperature reference from: Internal sensor combine with External sensor</p> <p>Combination ratio: 50% Internal to 50% External</p> <p>Time period for request room temperature sensor [0...255]: 10 min</p> <p>Send temperature when the result change by: 1.0K</p> <p>Cyclically send temperature [0...255]: 0 min</p> <p>Control value after temp. error[0..100] (if 2-point control, set value '0'=0, set value '>0'=1): 0 %</p> <hr/> <p>Room temperature control mode: Heating and Cooling</p> <p>Heating/Cooling switchover: <input checked="" type="radio"/> Via object <input type="radio"/> Automatic changeover</p> <p>Heating/Cooling status after download: <input checked="" type="radio"/> Heating <input type="radio"/> Cooling</p> <p>Heating/Cooling status after voltage recovery: As before voltage failure</p> <p>Room temperature control system: <input type="radio"/> 2 pipes system <input checked="" type="radio"/> 4 pipes system</p> <hr/> <p>Operation mode: <input checked="" type="checkbox"/></p> <p>Controller status after download: Comfort mode</p> <p>Controller status after voltage recovery: As before voltage failure</p> <p>Extended comfort mode [0..255,0=inactive]: 0 min</p> <p>1 bit object function for operation mode: <input checked="" type="checkbox"/></p> <p>1 bit object for standby mode: <input checked="" type="checkbox"/></p> <hr/> <p>Fan speed auto.control function: <input checked="" type="checkbox"/></p> <hr/> <p>Window contact input function: <input checked="" type="checkbox"/></p> <p>Delay for window contact [0..65535]: 15 s</p> <p>Controller mode for open window: <input type="radio"/> Economy mode <input checked="" type="radio"/> Frost/heat protection</p> <p>Bus presence detector function: <input checked="" type="checkbox"/></p>
--	---

Fig.5.5.1 “Controller x - RTC” parameter window

Parameter “Description (max 30char.)”

This parameter is for setting the name description for RTC, each device has corresponding name.

Parameter “Room temperature reference from”

This parameter is for setting the resource of the RTC function temperature reference. Options:

Internal sensor

External sensor

Internal sensor combine with External sensor

When selecting the reference internal sensor, the temperature is determined by the setting of the “Internal sensor” in the parameter interface, more details refer to chapter 5.2.

—Parameter “Time period for request room temperature sensor [0...255]min”

This parameter is visible when “...External sensor” is selected. Set the time period for read request external temperature sensor. Options: **0..255**

Parameters as follow are visible when “Internal sensor combine with External sensor” is selected.

—Parameter “Combination ratio”

This parameter is for setting the internal sensor and the external sensor to measure the specific gravity of the temperature. Options:

10% Internal to 90% External

20% Internal to 80% External

...

90% Internal to 10% External

For example, if the option is “40% internal to 60% external”, then the internal sensor accounts for 40%, the external sensor accounts for 60%, and the control temperature = (internal sensor's temperature × 40%) + (external sensor's temperature × 60%), the RTC function of the device will control and display the temperature according to the calculated temperature.

When two sensors are combined for detection, when one sensor is in error, the temperature value detected by the other sensor is used.

—Parameter “Send temperature when the result change by”

This parameter is for setting when temperature turns to a certain value, whether to enable to send the current temperature value to the bus. Not send when disable. Options:

Disable

0.5K

1.0K

...

10K

—Parameter “Cyclically send temperature [0...255]min”

Setting the time for cyclically sending the temperature detection value to the bus. Not send when value is 0.

Options: **0..255**

Note: cyclically sending and change sending are independent of each other.

Parameter “Control value after temp. error[0..100]% (if 2-point control, set value '0'=0, set value '>0'=1)”

This parameter is for setting the control value when temperature error occur. Options: **0..100**

If 2-Point control, then the parameter value is 0, as well as the control value; if the parameter value is more than 0, then the control value will be 1.

Parameter “Room temperature control mode”

This parameter is for setting room temperature control mode. Options:

Heating

Cooling

Heating and Cooling

Parameters as follow are visible when “Heating and Cooling” is selected

—Parameter “Heating/Cooling switchover”

This parameter is for setting the switchover way of Heating/Cooling. Options:

Via object

Automatic changeover

—Parameter “Heating/Cooling status after download”

This parameter is for setting the heating/cooling control mode of device when power on RTC after download.

Options:

Heating

Cooling

—Parameter “Heating/Cooling status after voltage recovery”

This parameter is for setting the heating/cooling control mode of device when power on RTC after

voltage recovery. Options:

Heating

Cooling

As before voltage failure

As before voltage failure: When the device is reset after power on, the control mode will recover as before voltage failure. If it is the first time the device is used or a newly enabled function page, the control mode after the device is started is in an uncertain state, and it needs to be manually selected at this time.

——**Parameter “Room temperature control system”**

This parameter is for setting the type of RTC control system, that is, pipe types of fan coil water inlet/outlet. Options:

2 pipes system

4 pipes system

2 pipes system: Shares an inlet and outlet pipe for heating and cooling, that is, both hot and cold water are controlled by a valve.

4 pipes system: Has its own inlet and outlet pipes for heating and cooling, and two valves are needed to control the entry and exit of hot water and cold water respectively.

Parameter “Operation mode”

This parameter is for setting whether to enable RTC operation mode.

When enable, support 4 modes with comfort, standby, economy and frost/heat protection. Support datatype of 1bit and 1byte, and preset a operation mode when download and voltage recovery.

Parameters as follow are visible when operation mode enabled.

——**Parameter “Controller status after download”**

This parameter is for setting the operation mode when power on RTC after download. Options:

Comfort mode

Standby mode

Economy mode

—Parameter “Controller status after voltage recovery”

This parameter is for setting the operation mode when power on RTC after voltage recovery.

Options:

Comfort mode

Standby mode

Economy mode

Frost/heat protection

As before voltage failure

—Parameter “Extended comfort mode [0..255,0=inactive]min”

This parameter is for setting the extended time of comfort mode. When value >0, activate the extended, and 1 bit object “Extended comfort mode” is visible. Options: **0..255**

When object receives telegram 1, comfort mode activation. If receive telegram 1 again during the delay time, the time is retiming. And comfort mode will return to previous operation mode once finish the timing. Exit the comfort mode when a new operation mode in delay time.

Switch operation will quit the timing, and heating/cooling switchover will not.

—Parameter “1 bit object function for operation mode”

This parameter is for setting whether to enable 1 bit objects of operation mode are visible. Corresponding mode activation when objects send telegram 1; Perform standby mode when object values of comfort, economy, protection received from the bus are 0.

—Parameter “1 bit object for standby mode”

This parameter is visible when previous parameter enabled. Set whether to enable 1 bit object of standby mode is visible.

Parameters as follow are visible when operation mode disabled.

—Parameter “Initial setpoint temperature (°C)”

This parameter is for setting the initial value of setpoint temperature. Options:

10.0

10.5

...

35.0

Automatic H/C mode changeover dead zone

—Parameter “Upper/Lower dead zone”

These two parameters are visible when control mode “Heating and Cooling” is selected, and “Automatic changeover” is selected. Setting the dead zone range of auto switchover heating/cooling.

Options:

0.5K

1.0K

...

10K

Under heating control, when the actual temperature(T) > or = the setpoint temperature + the upper dead zone, then mode heating switch to cooling;

Under cooling control, when the actual temperature(T) < or = the setpoint temperature + the upper dead zone, then mode cooling switch to heating.

Parameter “Fan speed auto control function”

This parameter is for setting whether to enable fan auto control interface is visible.

Parameter “Window contact input function”

This parameter is visible when RTC operation mode enabled. Set whether to link to window contact status.

—Parameter “Delay for window contact [0..65535]s”

This parameter is visible when RTC operation mode and window contact input function are enabled. Set the delay time to window contact detection. That is, when the window is open within the set value, the window is not open. If the time is out of the set value, the window is open. Options: **0..65535**

—Parameter “Controller mode for open window”

This parameter is visible when RTC operation mode and window contact input function are enabled. If window status is open, perform corresponding operation according to configuration. (For the

operation mode, the Switch and Setpoint temperature, as well as Heating/Cooling mode are recorded in the background if a control telegram is received, and performed after the window is closed. If no logging is received, return to the mode before the window was opened.) Options:

Economy mode

Frost/heat protection

Parameter "Bus presence detector function"

This parameter is visible when RTC operation mode enabled. Set whether to link to bus presence detector status.

If presence is detected, enter the comfort mode and recovery original mode after leaving. If there is a telegram/manual to adjust the mode, it will not recovery the previous mode after leaving. (If receive presence status cyclically, no comfort mode retriggered, and only can be after leaving.)

Parameter "Min./Max. setpoint temperature [5..37]°C"

These parameters are visible when RTC operation mode disabled. Set to limit the adjustable range of the setpoint temperature, the minimum value should be less than the maximum value. If the setpoint temperature beyond the limited range, the will output the limited temperature. Options:

5°C

6°C

...

37°C

These parameters are display below the parameters settings interface "Setpoint" when enable RTC operation mode.

5.5.1.1.Parameter window “Setpoint”

--- KNX Smart Touch with push button&Secure,3-gang > HVAC controller > Controller 1 - RTC > Setpoint

<ul style="list-style-type: none"> KNX Secure + General + Home page + Function page setting Internal temperature measurement + Input - HVAC controller <ul style="list-style-type: none"> Setpoint Heating control Cooling control Fan auto.control + Button + Logic function + Scene group function 	<p>Setpoint method for operating mode <input checked="" type="radio"/> Relative <input type="radio"/> Absolute</p> <p>Base setpoint temperature 20.0 °C</p> <p>Additional setpoint offset for setpoint adjustment <input checked="" type="radio"/> Disable <input type="radio"/> Enable</p> <p>Automatic H/C mode changeover dead zone (only for comfort mode)</p> <p>Upper dead zone 2.0 K</p> <p>Lower dead zone 2.0 K</p> <hr/> <p>Heating</p> <p>Reduced heating in standby mode [0..10] 2 K</p> <p>Reduced heating in economy mode [0..10] 4 K</p> <p>Setpoint temperature in frost protection mode [5..10] 7 °C</p> <p>Cooling</p> <p>Increased cooling in standby mode [0..10] 2 K</p> <p>Increased cooling in economy mode [0..10] 4 K</p> <p>Setpoint temperature in heat protection mode [30..37] 35 °C</p> <hr/> <p>Min. setpoint temperature [5..37] 10 °C</p> <p>Max. setpoint temperature [5..37] 32 °C</p>
---	--

Parameter setting of relative adjustment

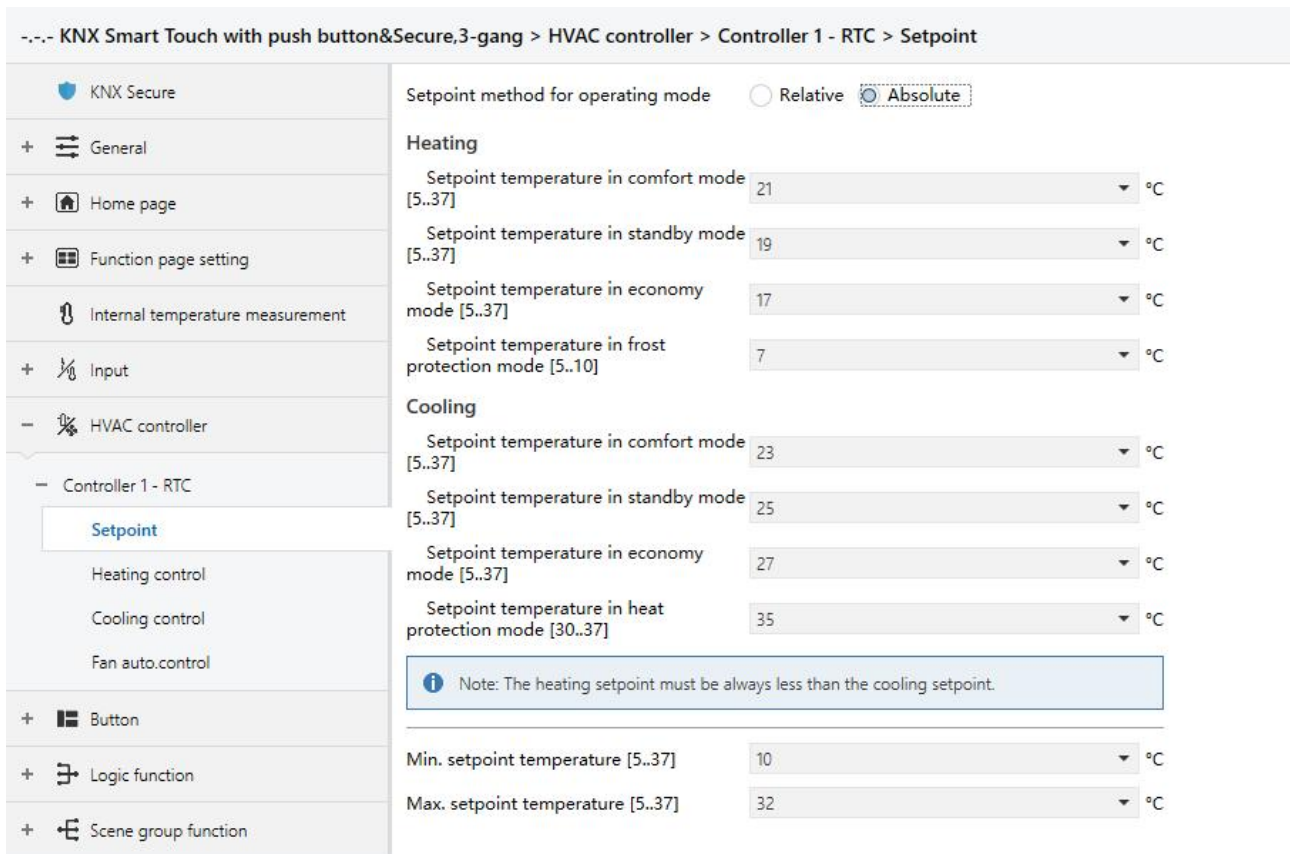

Parameter setting of absolute adjustment

Fig.5.5.1.1 "Setpoint" parameter window

Parameters of this window are visible when RTC operation mode enabled, display according to control mode.

Parameter "Setpoint method for operating mode"

This parameter is for setting the setpoint method for operating mode. Options:

Relative

Absolute

Relative: Relative adjustment, the setting temperature of economy mode and standby mode will refer to the defined temperature setpoint.

Absolute: Absolute adjustment, each mode has its independent temperature setpoint.

Parameters as follow are visible when the setpoint temperature adopts the relative adjustment method.

Parameter "Base setpoint temperature (°C)"

This parameter is for setting the basic setpoint temperature, from which the initial setpoint temperature of the room comfort mode is obtained. Options:

10.0

10.5

...

35.0

The setpoint value will be modified through object "Base setpoint adjustment", then the new value will be stored after the device power off.

Current basic setpoint temperature = modified basic setpoint temperature +/- accumulated offset(if existence)

When adjusting the setpoint temperature of current operation mode, the setpoint value will be changed with it, but the relative temperature of each mode is unchanged. Relative temperature of standby, economy and comfort mode is set by the parameters as follows.

Parameter "Additional setpoint offset for setpoint adjustment"

This parameter is for setting whether to enable additional setpoint offset function for setpoint adjustment, mainly used to adjust setpoint temperature by 1 bit object. Options:

Disable

Enable

Increase/decrease offset by 1 bit object "Setpoint offset", adjust the setpoint temperature indirectly, and send offset value to the bus by 2 byte object "Float offset value". Also reset the offset value by 1 bit object "Setpoint offset reset", modified the offset value by 2 byte object "Float offset value". Save the offset value when control mode and operation mode changed.

Three parameters as follow are visible when offset function enabled.

—Parameter "Step of setpoint offset"

This parameter is for setting step value of setpoint offset increased/decreased when receiving

telegrams. Telegram 1- increase, telegram 0- decrease. Accumulated offset can be saved when power off. Options:

0.5K

1K

Setpoint temperature of current mode = base temperature + fix offset of mode + accumulated additional offset

Note: Fix offset of mode is the offset of standby and economy modes compared to comfort mode, which is decided by the follow parameters of heating/cooling. Accumulated additional offset is adjusted by 1bit object "Setpoint offset", or directly modified the offset value by 2 byte object "Float offset value".

—Parameter "Min. setpoint offset [-10..0]K"

This parameter is for setting the maximum offset allowed when negative offset (setpoint temperature is decreased). Options: **-10..0**

—Parameter "Max. setpoint offset [0..10]K"

This parameter is for setting the maximum offset allowed when forward offset (setpoint temperature is increased). Options: **0..10**

Automatic H/C mode changeover dead zone (only for comfort mode)

Parameter "Upper/Lower dead zone"

These two parameters are visible when control mode "Heating and Cooling" is selected, and "Automatic changeover" is selected. Setting the dead zone range of auto switchover heating/cooling.

Options:

0.5K

1.0K

...

10K

Under heating control, when the actual temperature(T) > or = the setpoint temperature + the upper dead zone, then mode heating switch to cooling;

Under cooling control, when the actual temperature(T) < or = the setpoint temperature + the upper dead zone, then mode cooling switch to heating.

Parameter "Reduced heating in standby mode [0...10]K"

Parameter "Increased cooling in standby mode [0...10]K"

These two parameters are for setting the setpoint of standby mode. Options:

0K

1K

...

10K

Heating: The setpoint of standby mode is the temperature setpoint minus the reference value;

Cooling: The setpoint of standby mode is the temperature setpoint plus the reference value.

Parameter "Reduced heating in economy mode [0...10]K"

Parameter "Increased cooling in economy mode [0...10]K"

These two parameters are for setting the setpoint of economy mode. Options:

0K

1K

...

10K

Heating: The setpoint of economy mode is the temperature setpoint minus the reference value;

Cooling: The setpoint of economy mode is the temperature setpoint plus the reference value.

Parameter "Setpoint temperature in frost protection mode [5...10]°C"

This parameter is for setting the setpoint of frost protection mode. Options:

5°C

6°C

...

10°C

Under the frost protection mode, when room temperature reduce to the setpoint, the controller will trigger a control telegram so that related heating controller will output heating control to prevent the temperature from being too low.

Parameter "Setpoint temperature in heat protection mode [30...37]°C"

This parameter is for setting the setpoint of heat protection mode. Options:

30°C

31°C

...

37°C

Under the heat protection mode, when room temperature raise to the setpoint, the controller will trigger a control telegram so that related cooling controller will output cooling control to prevent the temperature from being too high.

Parameters as follow are visible when the setpoint temperature adopts the absolute adjustment method.

Parameter "Setpoint temperature in comfort mode [5...37]°C"

Parameter "Setpoint temperature in standby mode [5...37]°C"

Parameter "Setpoint temperature in economy mode [5...37]°C"

These parameters are for setting the setpoint temperature in comfort, standby and economy mode when heating or cooling. Options:

5°C

6°C

...

37°C

Parameter "Setpoint temperature in frost protection mode [5...10]°C"

This parameter is for setting the setpoint temperature in frost protection mode when heating.

Options:

5°C

6°C

...

10°C

Parameter "Setpoint temperature in heat protection mode [30...37]°C"

This parameter is for setting the setpoint temperature in heat protection mode when cooling.

Options:

30°C

31°C

...

37°C

 Note: The heating setpoint must be always less than the cooling setpoint.

For absolute adjustment mode, "Heating and Cooling" and "Automatic changeover" are selected, the note is visible. The heating setpoint value must be less than or equal to the cooling of the same operation mode, if not, it can not be configured on ETS. It is also applied to "Via object"

1. When the ambient temperature is higher than the setpoint temperature of current mode, it is changed to cooling mode; When the ambient temperature is lower than the setpoint temperature of current mode, it is changed to heating mode.

2. In the same operation mode, the setpoint temperature difference between cooling and heating remains constant, whether it is written from the bus or adjusted on the panel. That is, when adjust the setpoint temperature, it need to update cooling and heating setpoint temperature of current operation mode at the same time.

3. For the abnormal configuration where the heating setpoint value is greater than the cooling, it is depend on the setpoint temperature and ambient temperature to adjust heating/cooling mode, that is, change to cooling when ambient temperature is higher than the setpoint temperature in the current operation mode of cooling, while change to heating when ambient temperature is lower than the setpoint temperature in the current operation mode of cooling.

4. When receiving setpoint temperature from bus, it is still necessary to limit the value according to the high and low thresholds, that is heating and cooling temperature neither can not be lower than the min., or can not be higher than the max..

Points 2 and 4 also apply to "Via object".

Note: for relative/absolute adjustment, in protection mode, the setpoint temperature is only configured via ETS. When the received setpoint value from bus is different from the ETS configuration, the value is not updated and returned to the current setpoint temperature, to update synchronously to other devices on the bus.

5.5.1.2.Parameter window “Heating/Cooling control”

--- KNX Smart Touch with push button&Secure,3-gang > HVAC controller > Controller 1 - RTC > Heating/Cooling control

<ul style="list-style-type: none"> KNX Secure General Home page Function page setting Internal temperature measurement Input HVAC controller 	<p>Type of heating/cooling control: Switching on/off(use 2-point control)</p> <p>Invert control value: <input checked="" type="radio"/> No <input type="radio"/> Yes</p> <p>Heating</p> <p>Lower Hysteresis [0..200]: 10 *0.1K</p> <p>Upper Hysteresis [0..200]: 10 *0.1K</p> <p>Cooling</p> <p>Lower Hysteresis [0..200]: 10 *0.1K</p> <p>Upper Hysteresis [0..200]: 10 *0.1K</p> <p>Cyclically send control value [0..255]: 10 min</p>
---	--

Parameter setting of “Switching on/off(use 2-point control)”

--- KNX Smart Touch with push button&Secure,3-gang > HVAC controller > Controller 1 - RTC > Heating/Cooling control

<ul style="list-style-type: none"> KNX Secure General Home page Function page setting Internal temperature measurement Input HVAC controller 	<p>Type of heating/cooling control: Switching PWM(use PI control)</p> <p>Invert control value: <input checked="" type="radio"/> No <input type="radio"/> Yes</p> <p>PWM cycle time [1..255]: 15 min</p> <p>Heating speed: User defined</p> <p>Proportional range [10..100]: 40 *0.1K</p> <p>Reset time [0..255]: 150 min</p> <p>Cooling speed: Cooling ceiling (5K/240min)</p> <p>Cyclically send control value [0..255]: 10 min</p>
---	--

Parameter setting of “Switching PWM(use PI control)”

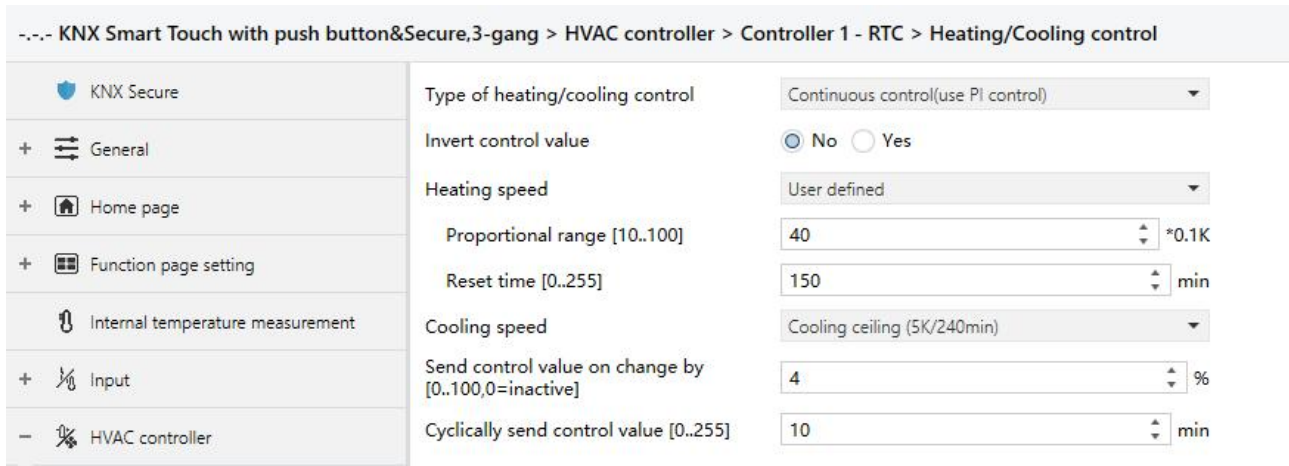

Parameter setting of "Continuous control(use PI control)"
 Fig.5.5.1.2 "Heating/Cooling control" parameter window

Parameters of this window display according to control mode and control system(2 pipe or 4pipe).

Parameter "Type of heating/cooling control"

This parameter is for setting the type of heating/cooling control. Different control types are suitable for controlling different temperature controllers. Options:

Switching on/off(use 2-point control)

Switching PWM(use PI control)

Continuous control(use PI control)

Parameter "Invert control value"

This parameter is for setting whether to invert control value or normal sending control value, so that the control value will be suitable for the valve type. Options:

No

Yes

Yes: Sending the control value to the bus through objects after inverting the control value.

Two parameters as follow are suitable for 2 point control:

—Parameter "Lower Hysteresis [0...200]*0.1K "

—Parameter "Upper Hysteresis [0...200]*0.1K "

These two parameters are for setting the lower/upper hysteresis temperature in HVAC heating or cooling. Options: **0..200**

Under heating control,

When the actual temperature(T) > the setting temperature + the upper hysteresis temperature, then will stop heating;

When the actual temperature(T) < the setting temperature - the lower hysteresis temperature, then will start heating.

For example, the lower hysteresis temperature is 1K, the upper hysteresis temperature is 2K, the setting temperature is 22°C, if T is higher than 24°C, then it will stop heating; if T is lower than 24°C, then it will start heating; if T is between 21~24°C, then it will maintain the previous status.

Under the cooling control,

When the actual temperature (T) < the setting temperature -the lower hysteresis temperature, then will stop cooling;

When the actual temperature (T) > the setting temperature +the upper hysteresis temperature, then will start cooling.

For example, the lower hysteresis temperature is 1K, the upper hysteresis temperature is 2K, the setting temperature is 26°C, if T is lower than 25°C, then it will stop cooling; if T is lower than 28°C, then it will start cooling; if T is between 28~25°C, then it will maintain the previous status.

2-point control mode is a very simple control mode. When adopting this control mode, it is necessary to set the upper hysteresis temperature and the lower hysteresis temperature through parameters. When setting the hysteresis temperature, the following effects need to be considered

1. When hysteresis interval is small, the temperature range will be small, however, frequent sending of control value will bring large load to the bus;

2. When hysteresis interval is large, the switch switching frequency will be low, but it is easy to cause uncomfortable temperature change.

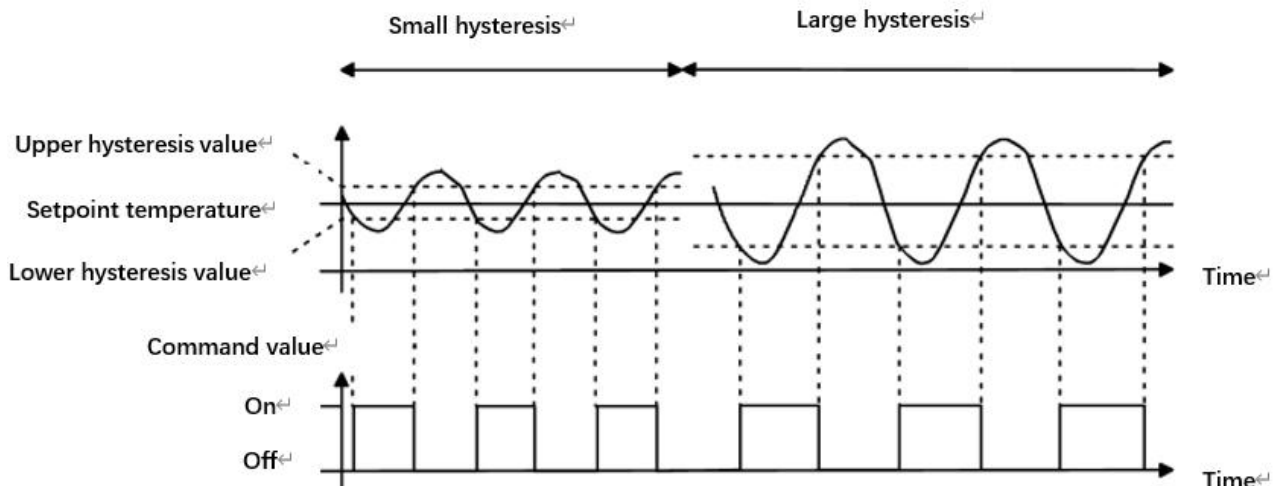

Fig.5.5.1.2(2) Effects of hysteresis on control value switch action(heating) under 2-point control mode

Two parameters as follow are suitable for PI control:

——Parameter "Heating speed "

——Parameter "Cooling speed"

These two parameters are for setting the responding speed of heating or cooling controller. Different responding speeds are suitable for different environments.

Options:

- Hot water heating (5K/150min)**
- Underfloor heating (5K/240 min)**
- Electrical heating (4K/100min)**
- Split unit (4K/90min)**
- Fan coil unit (4K/90min)**
- User defined**

Options

- Cooling ceiling (5K/240min)**
- Split unit (4K/90min)**
- Fan coil unit(4K/90min)**
- User defined**

——Parameter "Proportional range [10..100]*0.1K"(P value)

—Parameter “Reset time [0..255]min”(I value)

These two parameters are visible when “User defined” is selected. Set the PI value of PI controller.

Options: **10..100 (P value)**

Options: **0..255 (I value)**

—Parameter “PWM cycle time [1...255]min”

This parameter is only visible when the control type is “Switching PWM(use PI control)”. Set the period of the control object cycle to send the switch value, the object sends the switch value according to the duty cycle of the control value. For example, if the set period is 10 min and the control value is 80%, then the object will send an open telegram for 8 min. If the control value is changed, the time duty ratio of the on/ off telegram of the object will also change, but the period is still the time of parameter setting.

Options: **1..255**

The PI values of “Switching PWM (use PI control)” and “Continuous control (use PI control)” are the same, only different in control objects, the control object of “Continuous control” output PI value(1byte) directly, while the control value of “Switching PWM” output a “on/off” telegram according to the duty cycle of the control value.

—Parameter “Send control value on change by [0...100,0=inactive]”

This parameter is visible when control type is “Continuous control (use PI control)”, for setting the changing value of the control value to be sent to the bus. Options: **0..100, 0=inactive**

Parameter “Cyclically send control value [0...255]min”

This parameter is for setting the period for cyclically sending the control value to the bus. Options: **0..255**

In PI control mode, the predefined control parameters of each PI controller in heating or cooling system are recommended as follows:

(1) Heating

Heating type	P value	I value(integration time)	Recommended PI control type	Recommended PWM period
Hot water Heating	5K	150min	Continuous/PWM	15min
Underfloor heating	5K	240min	PWM	15-20min
Electrical heating	4K	100min	PWM	10-15min
Split unit	4K	90min	PWM	10-15min
Fan coil unit	4K	90min	Continuous	--

(2) Cooling

Cooling type	P value	I value(integration time)	Recommended PI control type	Recommended PWM period
Cooling ceiling	5K	240min	PWM	15-20min
Split unit	4K	90min	PWM	10-15min
Fan coil unit	4K	90min	Continuous	--

(3) User defined

When the parameter "Heating/Cooling speed" is set to "User defined", the parameter value of P (scale factor) and I (integration time) can be set through the parameter. When adjusting the parameters, refer to the fixed PI value mentioned in the above table. Even if the control parameters are adjusted slightly, the control behavior will be significantly different.

In addition, the integration time should be set properly. If the integration time is too long, the adjustment will be slow, and the oscillation will not be obvious; if the integration time is too small, the adjustment will be fast, but the oscillation will occur. 0 means the integral term is not used.

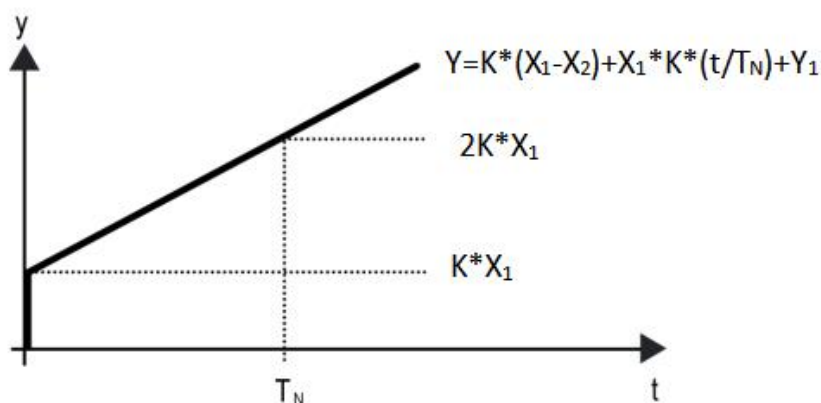

Fig.5.5.1.2 (3) control value of PI control mode

Y: control value

Y1: last control value

X1: temperature deviation = set temperature - actual temperature

X2: last temperature deviation = set temperature - actual temperature

T_N : integration time

K: scale factor (the scale factor is not zero)

PI control algorithm: $Y = K \cdot (X_1 - X_2) + X_1 \cdot K \cdot t / T_N + Y_1$

When the integration time is set to zero, the PI control algorithm is: $Y = K \cdot (X_1 - X_2) + Y_2$

Setting and influence of user-defined parameters:

Parameter setting	Effect
K: If the scale range is too small	Quick adjustment, and overshoot will occur
K: If the scale range is too small	Slow adjustment, but no overshoot
T_N : If the integration time is too short	Quick adjustment, but there will be oscillation
T_N : If the integration time is too long	Slow adjustment, no obvious oscillation

5.5.1.3. Parameter window “Fan auto.control”

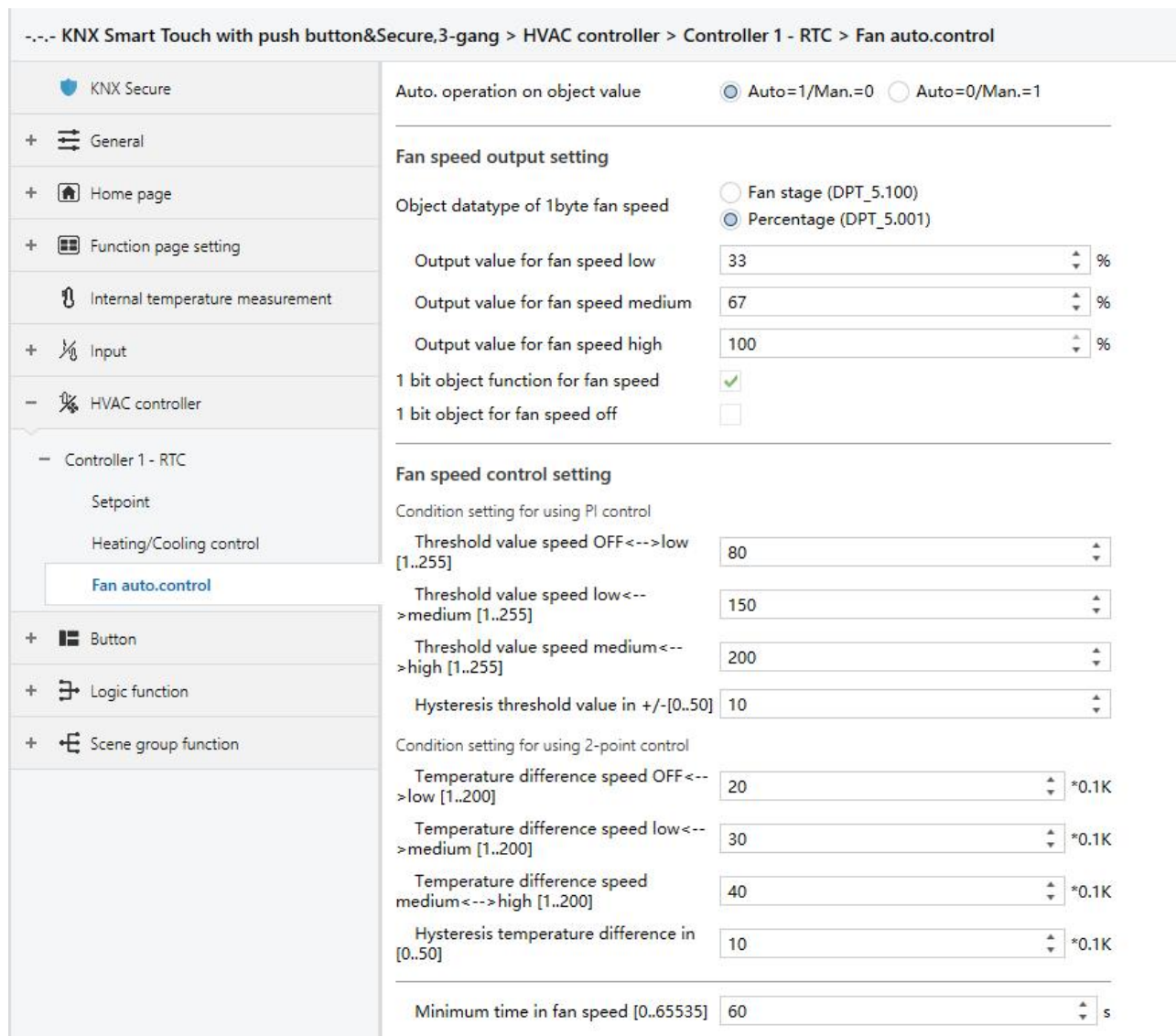

Fig.5.5.1.3 “Fan auto.control” parameter window

Parameters of this window are visible when fan auto control enabled.

Parameter “Auto. operation on object value”

This parameter is for setting the telegram value to activate automatic operation. Options:

Auto=1/Man.=0

Auto=0/Man.=1

Auto=1/Man.=0: When the object “Fan automatic operation” receives the telegram value “0”, activate the automatic operation, when receive “1”, exit the automatic operation.

Auto=0/Man.=1: When the object “Fan automatic operation” receives the telegram value “1”, activate the automatic operation, when receive “0”, exit the automatic operation.

After power-on, automatic operation is not activated by default.

Fan speed output setting

Parameter "Object datatype of 1byte fan speed"

This parameter is for setting the object datatype of 1 byte fan speed. Options:

Fan stage (DPT 5.100)

Percentage (DPT 5.001)

--- Parameter "Output value for fan speed low/medium/high"

These three parameters are for setting the value sent for each fan speed switchover. Fan speed off when value is 0. Options according to fan object datatype: **1..255 /1..100**

Parameter "1 bit object function for fan speed"

This parameter is for setting whether to enable 1 bit object function for fan speed. 1 bit control objects of each fan speed are visible when enabled.

--- Parameter "1 bit object for fan speed off "

This parameter is visible when previous parameter is enabled. Set whether to enable 1 bit object of fan speed off .

Fan speed control setting

Condition setting for using PI control

Under PI control, control value is PI operated within program, controller will power on/off fan or switch fan speed according to the threshold range of the control values.

Parameter "Threshold value speed OFF<-->low [1..255]"

Define threshold value for off-fan and low-level fan speeds, options: **1..255**

If the control value is greater than or equal to this setting threshold value, low-level fan speed will start running; if the control value is less than this setting threshold value, the fan will be turned off.

Parameter "Threshold value speed low<-->medium [1..255]"

Define the threshold value for switching the fan speed to medium fan speed, if the control value is greater than or equal to this setting threshold, the medium fan speed will start running. Options: **1..255**

Parameter "Threshold value speed medium<->high [1..255]"

Define the threshold for switching the fan speed to high fan speed, if the control value is greater than or equal to this setting threshold, the high fan speed will start running. Options: **1..255**

Tip: The controller evaluates the threshold in ascending order.

First check →OFF <->low fan speed threshold →low fan speed <->medium fan speed →medium fan speed <->high fan speed.

The correctness of functional execution is guaranteed only in this case:

The threshold of OFF <-> low fan speed is lower than that of low fan speed <-> medium fan speed, and the threshold of low fan speed <-> medium fan speed is lower than that of medium fan speed <-> high fan speed.

Parameter "Hysteresis threshold value in +/- [0..50]"

This parameter is for setting the hysteresis value of the threshold value, which can avoid the unnecessary action of the fan when the control value fluctuates near the threshold. Options: **0..50**

If value is 0, no hysteresis. Fan switch to speed once control value greater than threshold value;

Suppose that hysteresis value is 10 and the threshold is 50, then the upper limit threshold 60 (Threshold value+Hysteresis value) and the lower limit threshold 40 (Threshold value-Hysteresis value). When the control value is between 40 ~60, fan action will not be caused, and the previous status will still be maintained. Only less than 40 or greater than or equal to 60 will change the running status of the fan.

Condition setting for using 2-point control

Under 2-point control, controller will decide the fan power on/off or fan speed according to the temperature difference between the actual temperature and setpoint temperature.

Cooling: Temperature difference = actual temperature - setpoint temperature;

Heating: Temperature difference = setpoint temperature - actual temperature.

Parameter "Temperature difference speed OFF<->low [1..200] *0.1K"

This parameter is for setting the temperature difference between off-fan and low-level fan speeds.

Options: **1..200**

If the temperature difference is greater than or equal to this setting temperature difference, low-level fan speed will start running; if less than this setting temperature difference, the fan will be turned off.

Parameter "Temperature difference speed low<-->medium [1..200]*0.1K"

Define the temperature difference for switching the fan speed to medium fan speed, if the control value is greater than or equal to this setting temperature difference, the medium fan speed will start running.

Options: **1..200**

Parameter "Temperature difference speed medium<-->high [1..200]*0.1K"

Define the temperature difference for switching the fan speed to high fan speed, if the control value is greater than or equal to this setting temperature difference, the high fan speed will start running. Options: **1..200**

Parameter "Hysteresis temperature difference in [0..50] *0.1K"

This parameter is for setting the hysteresis value of the temperature difference, which can avoid the unnecessary action of the fan when the control value fluctuates near the temperature difference.

Options: **0..50**

If value is 0, no hysteresis. Fan switch to speed once control value greater than temperature difference;

Suppose that hysteresis value is 0.5°C and the temperature difference is 1°C, then the upper limit temperature difference 1.5°C (Temperature difference+Hysteresis value) and the lower limit temperature difference 0.5°C (Temperature difference-Hysteresis value). When the control value is between 0.5°C~1.5°C, fan action will not be caused, and the previous status will still be maintained. Only less than 0.5°C or greater than or equal to 1.5°C will change the running status of the fan.

Parameter "Minimum time in fan speed [0..65535]s"

Defines the residence time of the fan from the current fan speed to a higher fan speed or lower fan speed, that is, the minimum time for a fan speed operation.

If you need to switch to another fan speed, you need to wait for this period of time before switching.

If the current fan speed has been running long enough, the fan speed can be changed quickly.

Options: **0..65535**

0: there is no minimum running time, but the delay switching time of fan speed still needs to be considered.

Note: The residence time for this parameter setting is only enabled in Auto mode.

5.5.2.Parameter window “Controller x - Ventilation”(x=1~6)

--- KNX Smart Touch with push button&Secure,3-gang > HVAC controller > Controller 1 - Ventilation

<ul style="list-style-type: none"> KNX Secure General Home page Function page setting Internal temperature measur... Input <ul style="list-style-type: none"> Input 1 - Send String HVAC controller <ul style="list-style-type: none"> Controller 1 - Ventilation Button Logic function Scene group function 	<p>Description (max 30char.)</p> <p>Auto.operation on object value <input checked="" type="radio"/> Auto=1/Man.=0 <input type="radio"/> Auto=0/Man.=1</p> <p>State of Auto.operation after startup <input checked="" type="radio"/> Disable <input type="radio"/> Enable</p> <p>Fan speed output setting</p> <p>Object datatype of 1byte fan speed <input type="radio"/> Fan stage (DPT_5.100) <input checked="" type="radio"/> Percentage (DPT_5.001)</p> <p>Output value for fan speed low 33 %</p> <p>Output value for fan speed medium 67 %</p> <p>Output value for fan speed high 100 %</p> <p>Fan speed control setting</p> <p>Control value reference from PM2.5</p> <p>Object datatype of PM2.5 <input checked="" type="radio"/> Value in ug/m3(DPT_7.001) <input type="radio"/> Float value in ug/m3(DPT_9.030)</p> <p>Time period for request control value [0...255] 10 min</p> <p>The fan speed status when the control value error OFF</p> <p>Threshold value OFF<-->speed low [1..999] 35</p> <p>Threshold value speed low<-->medium [1..999] 75</p> <p>Threshold value speed medium<-->high [1..999] 115</p> <p>Hysteresis value is threshold value in +/- [10..30] 10</p> <p>Minimum time in fan speed [0...65535] 10 s</p>
---	---

Fig.5.5.2 “Controller x - Ventilation” parameter window

Parameter "Description (max 30char.)"

This parameter is for setting the name description for ventilation controller, each device has corresponding name.

Parameter "Auto. operation on object value"

This parameter is for setting the telegram value to activate automatic operation. Options:

Auto=1/Man.=0

Auto=0/Man.=1

Auto=1/Man.=0: When the object "Fan automatic operation" receives the telegram value "0", activate the automatic operation, when receive "1", exit the automatic operation.

Auto=0/Man.=1: When the object "Fan automatic operation" receives the telegram value "1", activate the automatic operation, when receive "0", exit the automatic operation.

After power-on, automatic operation is not activated by default.

Parameter "State of Auto.operation after startup"

This parameter is for setting whether to enable state of Auto.operation after startup the device.

Options:

Disable

Enable

Fan speed output setting

Parameter "Object datatype of 1byte fan speed"

This parameter is for setting the object datatype of 1 byte fan speed. Options:

Fan stage (DPT 5.100)

Percentage (DPT 5.001)

Parameter "Output value for fan speed low/medium/high"

These three parameters are for setting the value sent for each fan speed switchover. Fan speed off when value is 0. Options according to fan object datatype: **1..255 /1..100**

Fan speed control setting

Parameter "Control value reference from"

This parameter is for setting the reference of control value under automatic operation. Options:

PM2.5

CO2

VOC

——Parameter "Object datatype of PM2.5/VOC"

These parameters are for setting the datatype of PM2.5/VOC. Datatype determines object type, select it according to the docking PM2.5 or VOC sensor data type. Options:

Value in ug/m3(DPT 7.001)

Float value in ug/m3(DPT 9.030)

DPT_7.001: Suitable for integrated value.

DPT_9.030: Suitable for float value.

——Parameter "Object datatype of CO2"

This parameter is for setting the datatype of CO2. Datatype determines object type, select it according to the docking CO2 sensor data type. Options:

Value in ppm(DPT 7.001)

Float value in ppm(DPT 9.008)

DPT_7.001: Suitable for integrated value.

DPT_9.008: Suitable for float value.

Parameter "Time period for request control value [0...255]min"

This parameter is for setting the time period for device to send a control value read request to external sensor after bus recovery or finish programming (**After stabilization time 2min, then read**).

Options: **0..255**

Parameter "The fan speed status when the control value error"

This parameter is for setting the default fan speed of ventilation system when control value is error.

Options:

Off

Low

Medium

High

Parameter "Threshold value OFF<->speed low [1..999]/ [1..4000]"

Define threshold value for off-fan and low-level fan speeds, options: **1..999/1..4000**

If the control value is greater than or equal to this setting threshold value, low-level fan speed will start running; if the control value is less than this setting threshold value, the fan will be turned off.

Parameter "Threshold value speed low<->medium [1..999]/ [1..4000]"

Define the threshold value for switching the fan speed to medium fan speed, if the control value is greater than or equal to this setting threshold, the medium fan speed will start running. Options:

1..999/1..4000

Parameter "Threshold value speed medium<->high [1..999]/ [1..4000]"

Define the threshold for switching the fan speed to high fan speed, if the control value is greater than or equal to this setting threshold, the high fan speed will start running. Options: **1..999/1..4000**

Tip: The controller evaluates the threshold in ascending order.

First check →OFF <->low fan speed threshold →low fan speed <->medium fan speed →medium fan speed <->high fan speed.

The correctness of functional execution is guaranteed only in this case:

The threshold of OFF <-> low fan speed is lower than that of low fan speed <-> medium fan speed, and the threshold of low fan speed <-> medium fan speed is lower than that of medium fan speed <-> high fan speed.

Parameter "Hysteresis value is threshold value in +/- [10..30]/[100..400]"

This parameter is for setting the hysteresis value of the threshold value, which can avoid the unnecessary action of the fan when the control value fluctuates near the threshold. Options: **10..30/100..400**

For example, the control type is CO2, the Hysteresis value is 100 and the threshold is 450, then the upper limit threshold 550 (Threshold value+Hysteresis value) and the lower limit threshold 350 (Threshold value-Hysteresis value). When the control value is between 350 ~550, fan action will not be

caused, and the previous status will still be maintained. Only less than 350 or greater than or equal to 550 will change the running status of the fan. As shown in the following figure:

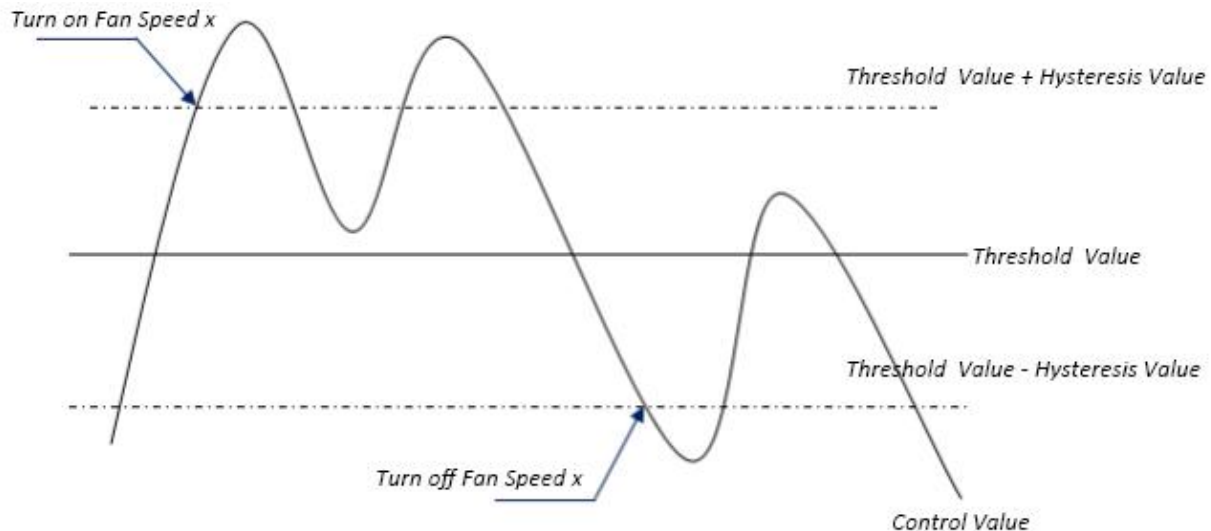

Note:

When hysteresis is enabled, if the threshold overlap occurs, fan action is specified as follows:

- 1) Hysteresis determines the control point where Fan speed conversion occurs;
- 2) If Fan speed conversion occurs, new fan speed is determined by control value and threshold

value, irrespective of hysteresis.

For example (1):

Take PM2.5 as an example

OFF <-> Low fan speed threshold value is 35

Low fan speed <-> Medium fan speed threshold value is 55

Medium fan speed <-> High fan speed threshold value is 75

Hysteresis value is 25

The fan speed of the fan turbine increases from OFF:

Fan OFF status will change at a control value of 60 ($\geq 25+35$), and new fan speed will be the mid-fan speed (because 60 is between 55 and 75, irrespective of hysteresis at this time), so the low fan speed is ignored;

The behavior of fan speed when descending from a high fan speed:

The high fan speed will change at a control value of 50 ($< 75-25$), and new fan speed will be low

fan speed (because 50 is between 35 and 55, irrespective of hysteresis), so the fan speed is ignored.

For example(2):

Take PM2.5 as an example

OFF <-> Low fan speed threshold value is 20

Low fan speed <->Medium fan speed threshold value is 40

Medium fan speed <-> High fan speed threshold value is 70

Hysteresis value is 10

When fan speed is increasing from OFF:

The OFF status will be turned when the control value is 30 ($\geq 20+10$)

When the control value 41 is received, the new speed will be at medium(because the hysteresis is ignored when the value 41 is between 40 and 70), therefore the low speed is ignored.

When the control value 39 is received, the new speed will be at low (because the hysteresis is ignored when the value 39 is between 20 and 40)

When Fan Speed decreasing from high:

The high speed will be turned when the control value is 60 ($< 70-10$)

When the control value 39 is received, the new speed will be at low(because the hysteresis is ignored when the value 39 is between 20 and 40),therefore the medium speed is ignored.

3) When the control value is 0,the fan will be off at any circumstances.

Parameter "Minimum time in fan speed [0..65535]s"

Defines the residence time of the fan from the current fan speed to a higher fan speed or lower fan speed, that is, the minimum time for a fan speed operation. Options: **0..65535**

If you need to switch to another fan speed, you need to wait for this period of time before switching.

If the current fan speed has been running long enough, the fan speed can be changed quickly.

0: there is no minimum running time, but the delay switching time of fan speed still needs to be considered.

Note: The residence time for this parameter setting is only enabled in Auto mode.

5.6.Parameter window “Home page”

5.6.1.Parameter window “Function”

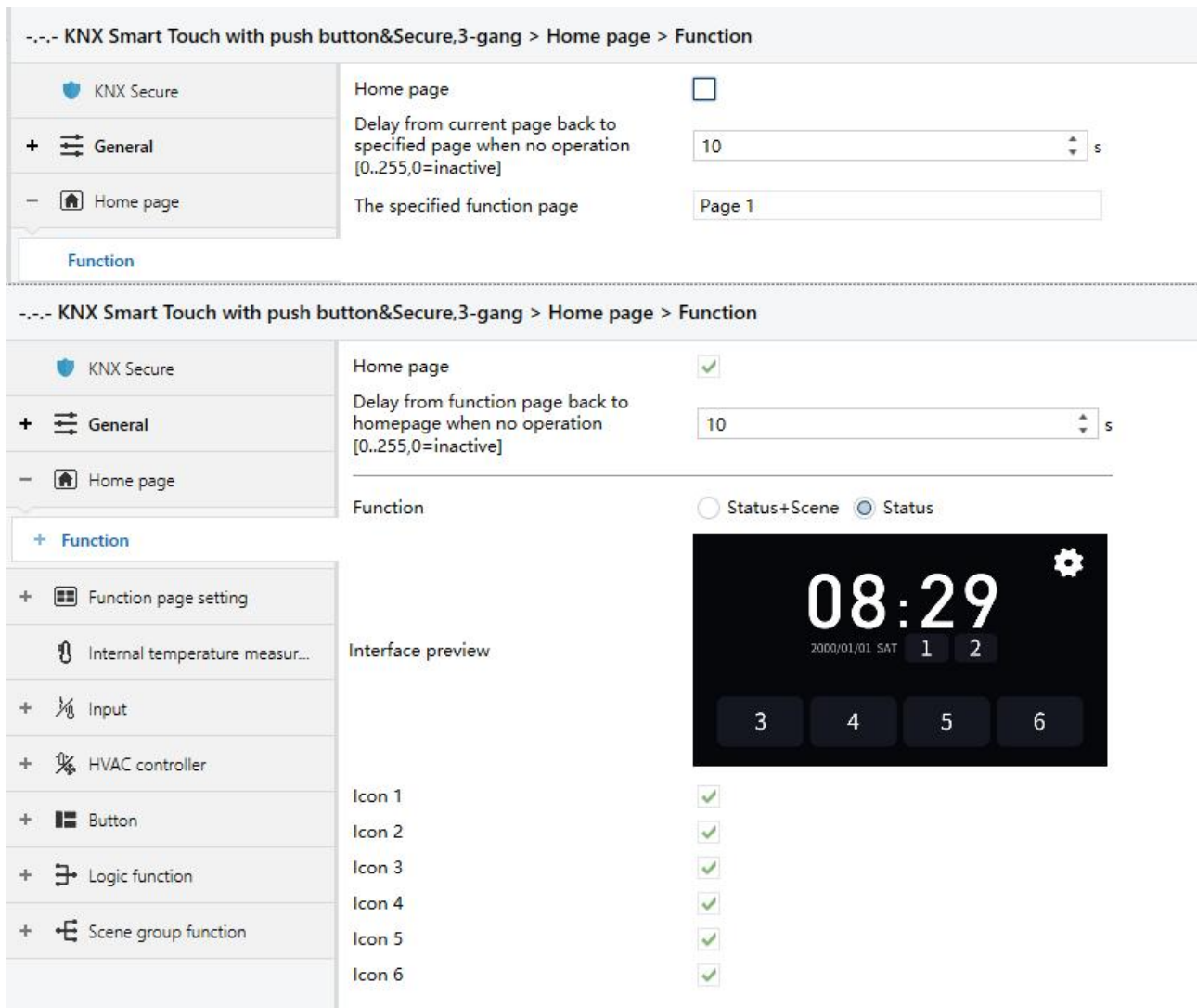

Fig.5.6.1 “Function” parameter window

Parameter “Home page”

This parameter is for setting enable home page, displays information about the date, time, and week; Other information is set by the parameters as follow.

Parameter “Delay from function page back to homepage when no operation [0..255,0=inactive]s”

This parameter is for setting the delay time for function page back to homepage when no operation. Do not automatically return when value is 0. Options: **0..255**

Parameters as follow are visible when home page disabled.

Parameter "The specified function page"

This parameter is visible when the delay time for returning to home page is not 0. Return to function page 1 by default

Parameters as follow are visible when home page enabled.

Parameter "Function"

This parameter is for setting the style of home page. Below the parameter, display the interface interview according to the options. Options:

Status+Scene Up to 4 icons

Status Up to 6 icons

Parameter "Icon x" (x=1~6)

This parameter is for setting whether to enable icon settings of home page, display corresponding interface when enable.

5.6.2.Parameter window “Icon x”(x=1~6)

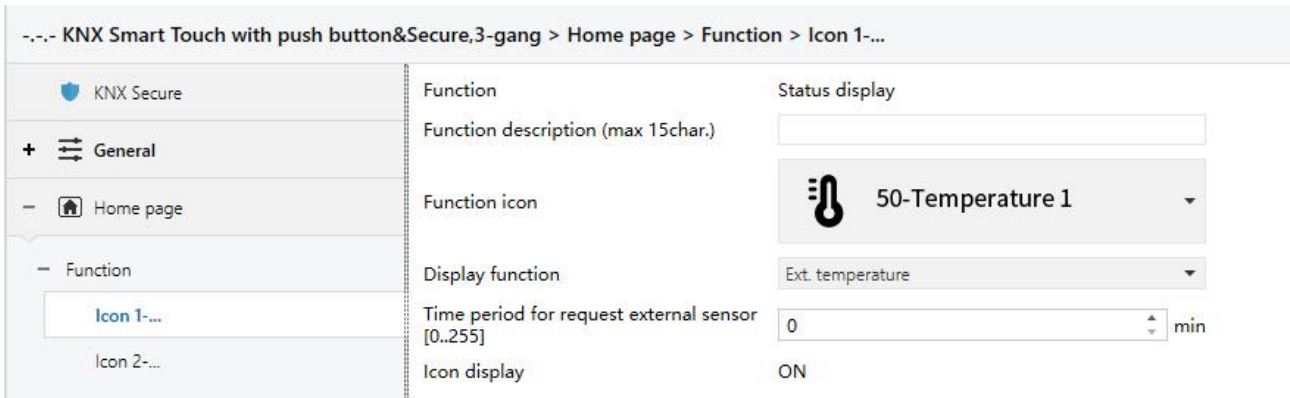

Parameter setting of status display

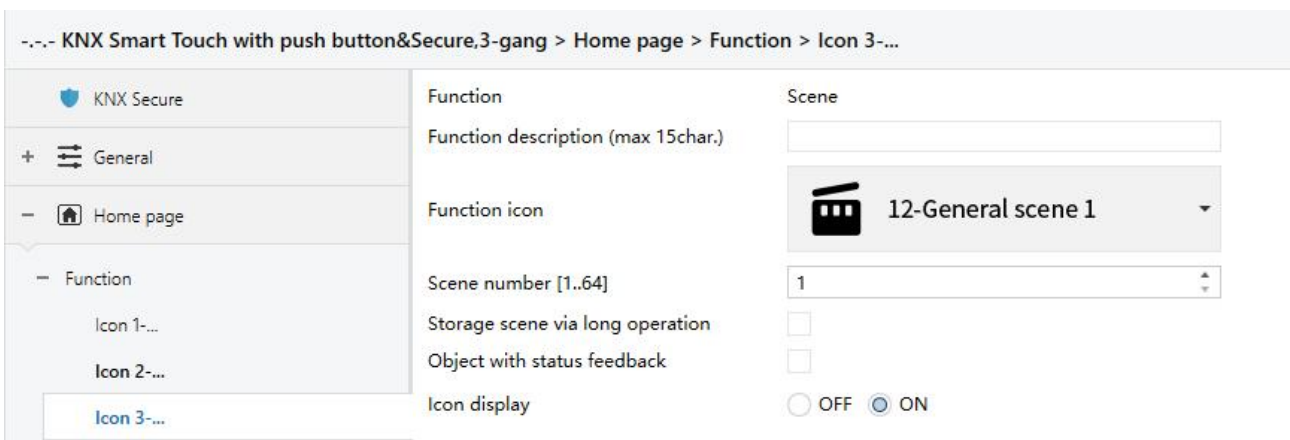

Parameter setting of scene function
Fig.5.6.2 “Icon x” parameter window

Parameter “Function”

This parameter is for setting the function of home page icons. Options of icon 1~6 are set according to style setting of home page:

When home page selects “Status+Scene”:

Icon 1~2 only support the function of status display; Icon 3~4 only support the function of scene.

When home page selects “Status”:

Icon 1~6 only support the function of status display

Parameter “Function description (max 15char.)”

This parameter is for setting the description of home page function icons. Up to input 15 characters, actually up to display 5 Chinese characters.

Parameter "Function icon"

This parameter is for setting the icon for home page using. Options:

01-General light

02-Ceiling light

...

80-Floor light

The default icons corresponding to the function and the icons corresponding to the options are described in the appendix.

Parameters as follow are visible when icon function of home page is scene.

Parameter "Scene number [1..64]"

This parameter is for setting the scene number. Options: **1..64**

Parameter "Storage scene via long operation"

This parameter is for setting whether to storage scene via long operation.

Short press to recall scene, long operation optionally determines whether to storage the scene, only occupy 1 button when link to the Mechanical key.

Parameter "Object with status feedback "

This parameter is for setting whether to support the object with status feedback.

Parameter "Icon display"

This parameter is visible when previous parameter is disabled. Set the indication status of the icon on the screen. Options:

OFF

ON

Parameters as follow are visible when icon function of home page is status display.

Parameter "Display function"

This parameter is visible when icon function is status display. Set the indication function of home page icons. Options of icon 1~6 is set according to home page style:

When select "Status+Scene", options:

Int. temperature

Int. humidity

Ext. temperature

Ext. humidity

When select "Status", options:

Int. temperature

Ext. humidity

VOC

Brightness

Int. humidity

PM2.5

CO2

Wind speed

Ext. temperature

PM10

AQI

Rain

Parameter "Object datatype of display PM2.5/PM10/VOC"

This parameter is visible when PM2.5/PM10/VOC is selected. Set the object datatype of display PM2.5/PM10/VOC. Options:

Value in ug/m3(DPT_7.001)

Float value in ug/m3(DPT_9.030)

Parameter "Object datatype of display CO2"

This parameter is visible when CO2 is selected. Set the object datatype of display CO2. Options:

Value in ppm(DPT_7.001)

Float value in ppm(DPT_9.008)

Parameter "Object datatype of display brightness"

This parameter is visible when brightness is selected. Set the object datatype of display brightness.

Options:

Brightness in lux(DPT_7.013)

Float value in lux(DPT_9.004)

Parameter "Object datatype of display wind speed"

This parameter is visible when wind speed is selected. Set the object datatype of display wind speed. Options:

Value in m/s(DPT_9.005)

Float value in km/h(DPT_9.028)

Parameter "Status text for rain (1-ON)"

Parameter "Status text for no rain (0-OFF)"

These parameters are visible when rain is selected. Set the status text for rain and no rain, and display the dynamic icon at the same time.

——Parameter "Time period for request external sensor [0..255]min"

This parameter is visible when external sensor is selected. Set the time period for device to send a control value read request to external sensor after bus recovery or finish programming. Not send when value is 0.

Options: **0..255**

Parameter "Icon display"

This parameter is for setting the indication status of the icon on the screen. Default read-only **ON**

5.7.Parameter window “Function page setting”

5.7.1.Parameter window “Page x”(x=1~6)

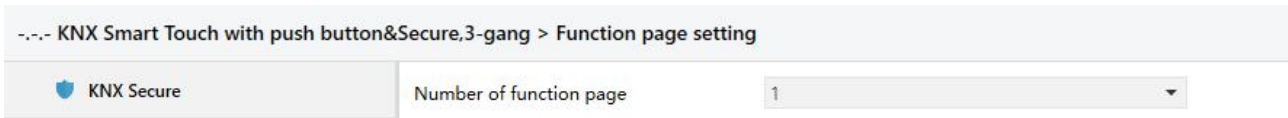

Fig.5.6.1(1) “Function page setting” parameter window

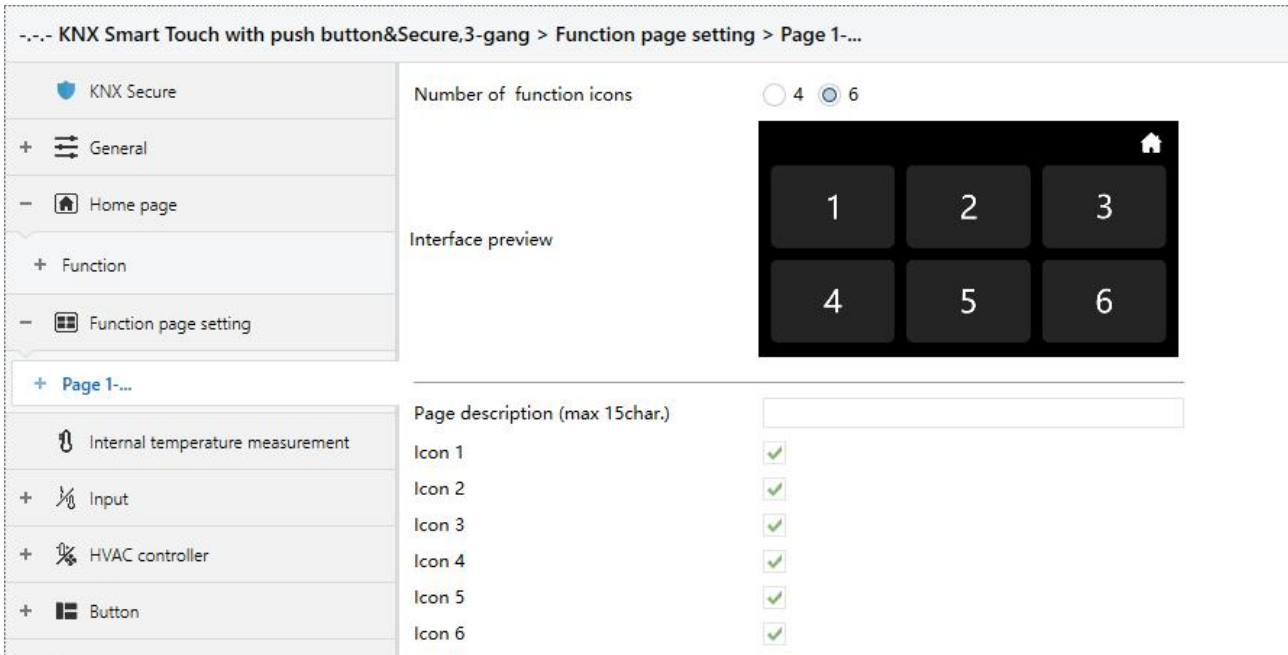

Fig.5.7.1(2) “Page x” parameter window

Parameter “Number of function page”

This parameter is for setting the number of function page. Up to support 6 function pages.

Parameter “Number of function icons”

This parameter is for setting the number of icons for current function page, each page up to support 6 icons. Below the parameter, display the interface interview according to the options. Options:

4

6

Parameter “Page description (max 15char.)”

This parameter is for setting the description of home page function icons. Up to input 15 characters, actually up to display 5 Chinese characters.

Parameter "Icon x" (x=1~6)

This parameter is for setting whether to enable the icon settings of function page, corresponding window are visible when enabled.

5.7.2.Parameter window "Icon x"(x=1~6)

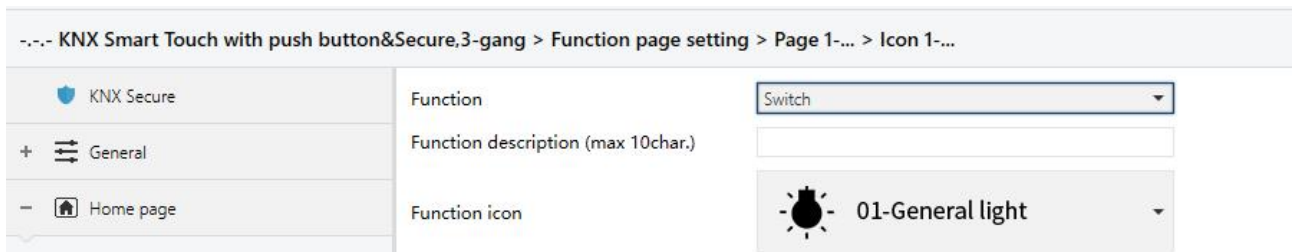

Fig.5.6.1 "Icon x" parameter window

Parameter "Function"

This parameter is for setting the function of the icons in function page. Options:

- | | |
|-----------------------------------|---|
| Switch | Curtain position |
| Press/Release switch | Roller blind position |
| Relative dimming | Venetian blind position and slat |
| Brightness dimming | Value sender |
| RGB dimming | Scene |
| RGBW dimming | Status display |
| RGBCW dimming | Air conditioner |
| Colour temperature dimming | Room temperature unit |
| Curtain step/move | Ventilation system |
| Roller blind step/move | Audio control |

Parameter "Function description (max 10char.)"

This parameter is for setting the description of home page function icons. Up to input 10 characters, actually up to display 5 Chinese characters.

Parameter "Function icon"

This parameter is for setting the icon for function page using. Options:

01-General light

02-Ceiling light

...

80-Floor light

The default icons corresponding to the function and the icons corresponding to the options are described in the appendix.

Chapters as follow explain the icon functions in function pages separately.

5.7.2.1.Parameter of basic function

This chapter explains the basic functions, including switch, dimming, curtain/blind, colour, colour temperature, value sender and scene.

1. Switch function

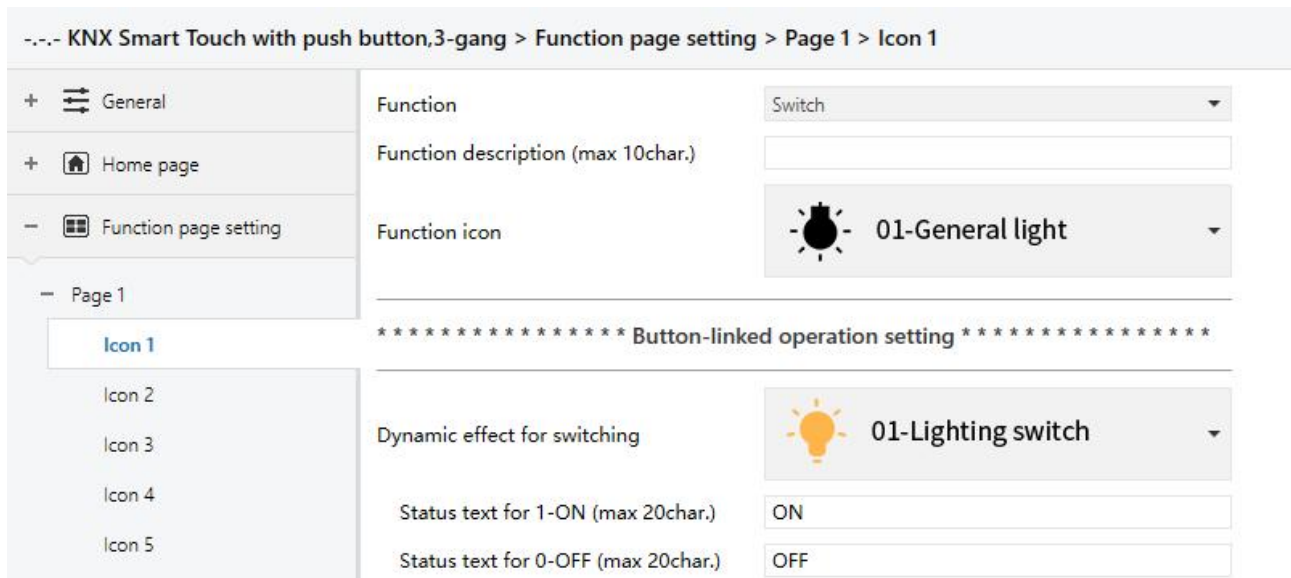

Fig.5.7.2.1 (1) Parameter setting of switch function

Some functions can be linked to dynamic function when the buttons are used as a customized shortcut key for touch screen functions. There will be a dynamic figure and text to display when operate the button, but no dynamic effect when operate the icon. You can see the specific effect displayed on the screen interface.

These three parameters used for ON/OFF dynamic setting of switch function.

Parameter "Dynamic effect when button-linked operation for switching"

This parameter is for setting the dynamic icon linked to switch function when the buttons are used as a custom shortcut key for touch screen functions.

- Disable**
- 01-Lighting switch**
- 02-Lighting dim**
- ...
- 16-Romantic**

The default icons corresponding to the function and the icons corresponding to the options are described in the appendix.

—Parameter “Status text for 1-ON (max 20char.)”

—Parameter “Status text for 0-OFF (max 20char.)”

These parameters are visible when previous parameter enabled. Set the status text for ON and OFF.

2. Press/Release switch function

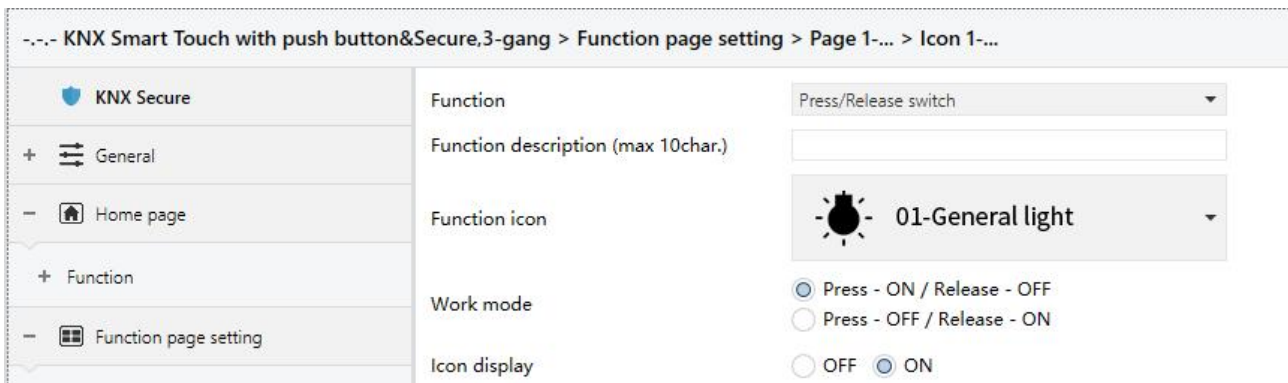

Fig.5.7.2.1 (2) Parameter setting of press/release switch function

Parameter “Work mode”

This parameter is for setting the On/Off value to send for press and release switch. Options:

Press - ON / Release - OFF

Press - OFF / Release - ON

Parameter “Icon display”

This parameter is for setting the indication status of the icon on the screen. Options:



OFF

ON

Note: this function is not supported to the dynamic effect.

3. Relative/Brightness dimming function

--- KNX Smart Touch with push button&Secure,3-gang > Function page setting > Page 1-... > Icon 1-...

<ul style="list-style-type: none"> KNX Secure + General - Home page + Function - Function page setting - Page 1-... <ul style="list-style-type: none"> Icon 1-... Icon 2-... Icon 3-... Icon 4-... Icon 5-... Icon 6-... Internal temperature measurement + Input + HVAC controller + Button 	Function	Relative dimming
	Function description (max 10char.)	
	Function icon	 01-General light
	Relative setting	
	Dimming mode	<input type="radio"/> Start-Stop dimming <input checked="" type="radio"/> Step dimming
	Step size	12.5 %
	Interval of tele. cyclic send [0..25,0=send once]	0 *0.1s
	***** Button-linked operation setting *****	
	Dynamic effect for switching	 02-Lighting dim
	Status text for 1-ON (max 20char.)	ON
Status text for 0-OFF (max 20char.)	OFF	
Dynamic effect for relative dimming	 02-Lighting dim	
Status text for dimming brighter (max 20char.)	Brighter	
Status text for dimming darker (max 20char.)	Darker	

Relative dimming

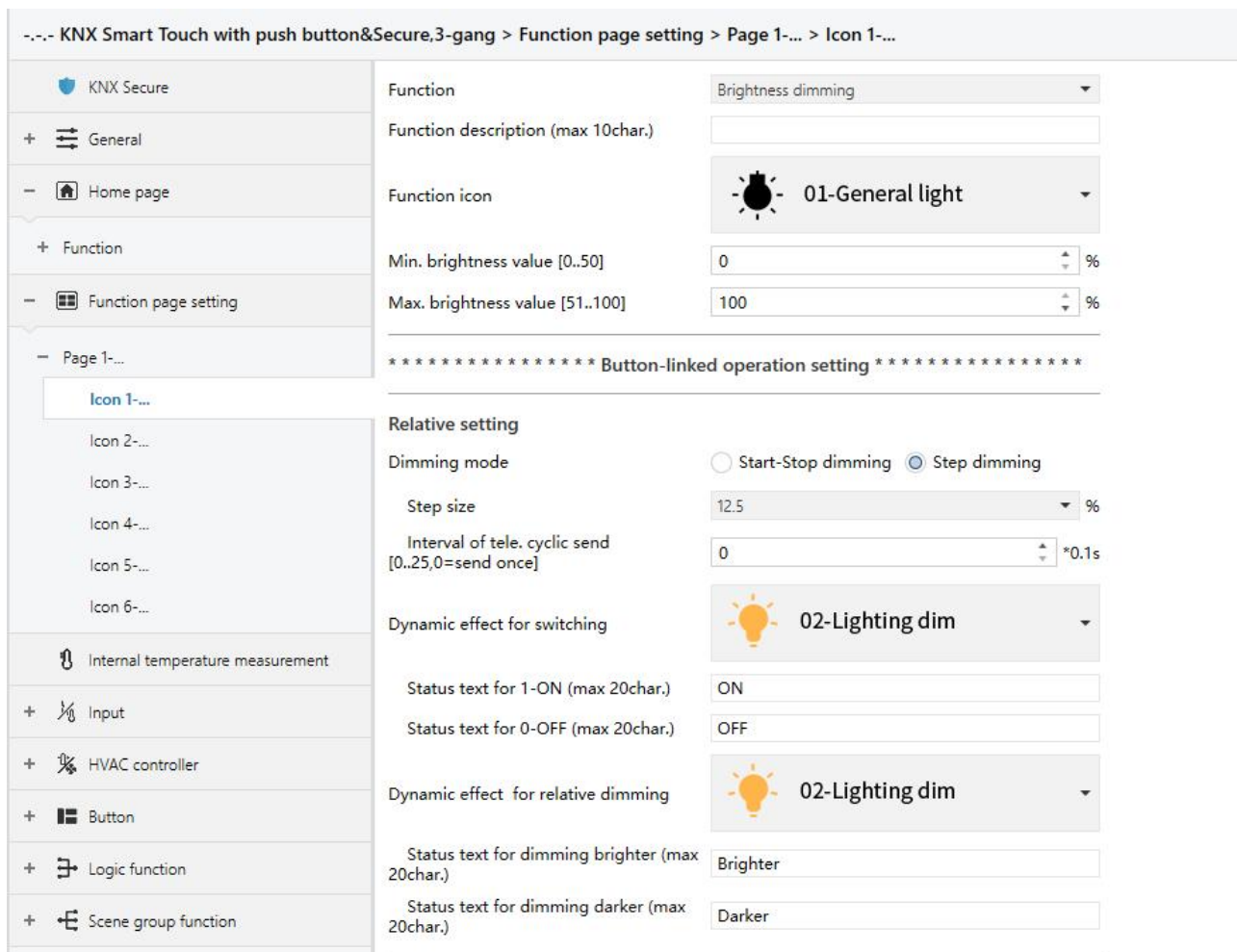

Brightness dimming(1)

Fig.5.7.2.1 (3) Parameter setting of dimming function

Two parameters as follow are visible when “Brightness dimming” is selected

Parameter “Min. brightness value [0..50]”

This parameter is visible when “Brightness dimming” is selected. Set the lower limit threshold of brightness.

Options: **0..50**

Parameter “Max. brightness value [51..100]”

This parameter is visible when “Brightness dimming” is selected. Set the upper limit threshold of brightness.

Options: **51..100**

Parameters as follow are visible when “Brightness dimming” is selected, or “Relative dimming” is selected and the button panel is selected “Customized linking to touch”

Relative setting suitable for the linking to the button

Note: Not required this function and 4 bit object when no Brightness Dimming function on the screen and button panel is not linking to the screen.

Parameter “Dimming mode”

This parameter is for setting the way of relative dimming. Options:

Start-Stop dimming

Step dimming

Start-stop dimming: The dimming mode will be start-stop, i.e. a dimming up or down telegram will be sent when the dimming starts, and a stop telegram will be sent when dimming ends. Here the dimming telegram will not be sent cyclically.

Steps dimming: The dimming mode will be a step one and the dimming telegram will be sent cyclically. When dimming ends, a stop dimming telegram will be sent immediately.

—Parameter “ Step size”

This parameter is visible when “Step dimming” is selected. Set a cyclically sending dimming telegram which changes the brightness percentage. Options:

100%

50%

...

1.56%

—Parameter “ Interval of tele. cyclic send [0..25,0=send once]*0.1s”

This parameter is visible when “Step dimming” is selected. Set intervals of cyclically sending dimming telegram. Options: **0..25, 0= Only send once**

These parameters used for ON/OFF dynamic setting of relative / brightness dimming function is the same as the switch function, here is no longer to repeat.

These three parameters used for Dimming Brighter/Darker dynamic setting of relative /brightness dimming function.

Parameter "Dynamic effect when button-linked operation for relative dimming"

This parameter is for setting the dynamic icon linked to relative dimming function when the buttons are used as a custom shortcut key for touch screen functions.

Disable

01-Lighting switch

02-Lighting dim

...

16-Romantic

The default icons corresponding to the function and the icons corresponding to the options are described in the appendix.

—Parameter "Status text for dimming brighter (max 20char.)"

—Parameter "Status text for dimming darker (max 20char.)"

These parameters are visible when previous parameter enabled. Set the status text for dimming brighter and dimming darker.

4. RGB/RGBW/RGBCW/Colour temperature dimming function

--- KNX Smart Touch with push button&Secure,3-gang > Function page setting > Page 1-... > Icon 1-...

	Function	RGB dimming
+	Function description (max 10char.)	<input type="text"/>
-	Function icon	08-RGB light
+	Reaction on off operation	<input checked="" type="radio"/> Only switch object send value 0 <input type="radio"/> Brightness objects send value 0
-	Object datatype	<input checked="" type="radio"/> 1x3byte <input type="radio"/> 3x1byte

RGB dimming

--- KNX Smart Touch with push button&Secure,3-gang > Function page setting > Page 1-... > Icon 1-...

	Function	RGBW dimming
+	Function description (max 10char.)	<input type="text"/>
-	Function icon	08-RGB light
+	Reaction on off operation	<input checked="" type="radio"/> Only switch object send value 0 <input type="radio"/> Brightness objects send value 0
-	Object datatype	<input checked="" type="radio"/> 1x6byte <input type="radio"/> 4x1byte

RGBW dimming

--- KNX Smart Touch with push button&Secure,3-gang > Function page setting > Page 1-... > Icon 1-...

	Function	RGBCW dimming
+	Function description (max 10char.)	<input type="text"/>
-	Function icon	08-RGB light
+	Reaction on off operation	<input checked="" type="radio"/> Only switch object send value 0 <input type="radio"/> Brightness objects send value 0
-	RGB object datatype	<input checked="" type="radio"/> 1x3byte <input type="radio"/> 3x1byte
-	Colour temperature control type	<input checked="" type="radio"/> Normal <input type="radio"/> Directly(with warm/cool white algorithm)
	Increase/Decrease step width	200 K
	Min. colour temperature [2000..7000]	2700 K
	Max. colour temperature [2000..7000]	6500 K

RGBCW dimming

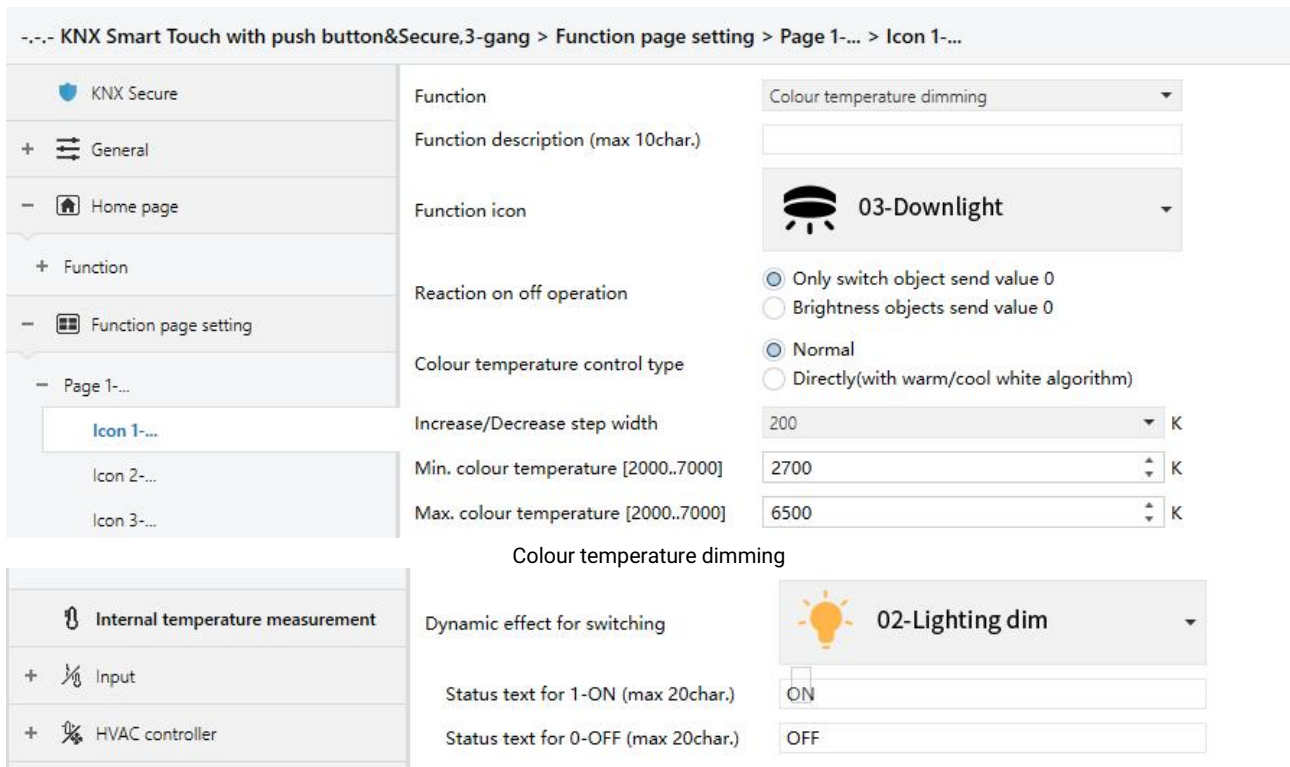

RGB / RGBW / RGBCW / Colour temperature dimming dynamic effect setting
 Fig.5.7.2.1 (4) Parameter setting of colour and colour temperature dimming function

Parameter "Reaction on "off "operation"

This parameter is for setting whether send switch telegram 0 when the switch button is operated off, or whether send brightness telegram 0. Options:

Only switch object send value 0

Brightness objects send value 0

Parameter "Object datatype" / "RGB object datatype "

This parameter is visible when "RGB dimming" or "RGBW dimming" or "RGBCW dimming" is selected. Set the object datatype of RGB or RGBW. Options:

Suitable for RGB type:

1x3byte

3x1byte

Suitable for RGBW type:

1x6byte

4x1byte

Parameters as follow are visible when “RGBCW dimming” or “Colour temperature dimming” is selected, used for setting colour temperature dimming.

Parameter “Colour temperature control type”

This parameter is for setting the control type of colour temperature. Options:

Normal

Directly(with warm/cool white algorithm)

Normal: Send value of 1byte brightness and 2 byte colour temperature;

Directly(with warm/cool white algorithm): Directly control, the has been built-in “Brightness + Colour Temperature”and Warm/cool white brightness, that is 2 objects of 1 byte, which is used for output brightness adjustment to control warm white LED and cool white LED.

—Parameter “Status feedback object”

This parameter is visible when previous parameter is selected “Directly(with warm/cool white algorithm)”. Set the status feedback object. Options:

Brightness+Colour Temperature

Warm/cool white brightness

Brightness+Colour Temperature: Feedback of Brightness+Colour Temperature is to communicate accurately with the data from the other panels.

Warm/cool white brightness: Feedback of Warm/cool white brightness is to communicate with actuator.

Parameter “Increase/Decrease step width*K”

This parameter is for setting the adjustment step value for the colour temperature icon to increase/decrease.

Options:

100

200

500

1000

Parameter "Min. colour temperature [2000..7000]K"

Parameter "Max. colour temperature [2000..7000]K"



These parameters are for setting the upper and lower limit threshold of colour temperature.

Options: **2000..7000**

These parameters used for ON/OFF dynamic setting of RGB / RGBW / RGBCW / colour temperature dimming function is the same as the switch function, here is no longer to repeat.



5. Curtain/Blind function

--- KNX Smart Touch with push button&Secure,3-gang > Function page setting > Page 1-... > Icon 1-...

<ul style="list-style-type: none"> KNX Secure + General - Home page + Function - Function page setting - Page 1-... <ul style="list-style-type: none"> Icon 1-... Icon 2-... Icon 3-... Icon 4-... 	Function	Curtain step/move
	Function description (max 10char.)	
	Function icon	 09-Curtain
	Icon display	<input type="radio"/> OFF <input checked="" type="radio"/> ON
	***** Button-linked operation setting *****	
	Dynamic effect for moving	 03-Curtain
	Status text for 1-Close (max 20char.)	Close
	Status text for 0-Open (max 20char.)	Open



Setting of Curtain step/move

--- KNX Smart Touch with push button&Secure,3-gang > Function page setting > Page 1-... > Icon 1-...

<ul style="list-style-type: none"> KNX Secure + General - Home page + Function - Function page setting - Page 1-... <ul style="list-style-type: none"> Icon 1-... Icon 2-... Icon 3-... Icon 4-... 	Function	Roller blind step/move
	Function description (max 10char.)	
	Function icon	 10-Roller blind
	Icon display	<input type="radio"/> OFF <input checked="" type="radio"/> ON
	***** Button-linked operation setting *****	
	Dynamic effect for moving	 04-Blind
	Status text for 1-Down (max 20char.)	Down
	Status text for 0-Up (max 20char.)	Up



Setting of Roller blind step/move

--- KNX Smart Touch with push button&Secure,3-gang > Function page setting > Page 1-... > Icon 1-...

<ul style="list-style-type: none"> KNX Secure + General - Home page + Function - Function page setting <ul style="list-style-type: none"> Page 1-... <ul style="list-style-type: none"> Icon 1-... Icon 2-... Icon 3-... 	Function	Curtain position
	Function description (max 10char.)	
	Function icon	 09-Curtain
	***** Button-linked operation setting *****	
	Dynamic effect for moving	 03-Curtain
Status text for 1-Close (max 20char.)	Close	
Status text for 0-Open (max 20char.)	Open	



Setting of Curtain position

--- KNX Smart Touch with push button&Secure,3-gang > Function page setting > Page 1-... > Icon 1-...

<ul style="list-style-type: none"> KNX Secure + General - Home page + Function - Function page setting <ul style="list-style-type: none"> Page 1-... <ul style="list-style-type: none"> Icon 1-... Icon 2-... Icon 3-... 	Function	Roller blind position
	Function description (max 10char.)	
	Function icon	 10-Roller blind
	***** Button-linked operation setting *****	
	Dynamic effect for moving	 04-Blind
Status text for 1-Down (max 20char.)	Down	
Status text for 0-Up (max 20char.)	Up	

Setting of Roller blind position

--- KNX Smart Touch with push button&Secure,3-gang > Function page setting > Page 1-... > Icon 1-...

<ul style="list-style-type: none"> KNX Secure + General - Home page + Function - Function page setting <ul style="list-style-type: none"> Page 1-... <ul style="list-style-type: none"> Icon 1-... Icon 2-... Icon 3-... 	Function	Venetian blind position and slat
	Function description (max 10char.)	
	Function icon	 11-Venetian blind
	***** Button-linked operation setting *****	
	Dynamic effect for moving	 04-Blind
Status text for 1-Down (max 20char.)	Down	
Status text for 0-Up (max 20char.)	Up	

Setting of Venetian blind position and slat

Fig.5.7.2.1 (5) Parameter setting of Curtain/Blind function

Parameter "Icon display"

This parameter is visible when "Curtain step/move" or "Roller blind step/move" is selected. Set setting the indication status of the icon on the screen. Options:

OFF

ON

These parameters as follow used for dynamic setting of Curtain/Blind function.

Parameter "Dynamic effect when button-linked operation for moving"

This parameter is for setting the dynamic icon linked to curtain/blind function when the buttons are used as a custom shortcut key for touch screen functions. Options:

Disable

01-Lighting switch

02-Lighting dim

...

16-Romantic

The default icons corresponding to the function and the icons corresponding to the options are described in the appendix.

—Parameter "Status text for 1-Close (max 20char.)"

—Parameter "Status text for 0-Open (max 20char.)"

These parameters are visible when previous parameter enabled. Set the status text for curtain Close and Open.

—Parameter "Status text for 1-Down (max 20char.)"

—Parameter "Status text for 0-Up (max 20char.)"

These parameters are visible when previous parameter enabled. Set the status text for roller blind or venetian blind Down and Up.

6. Value sender function

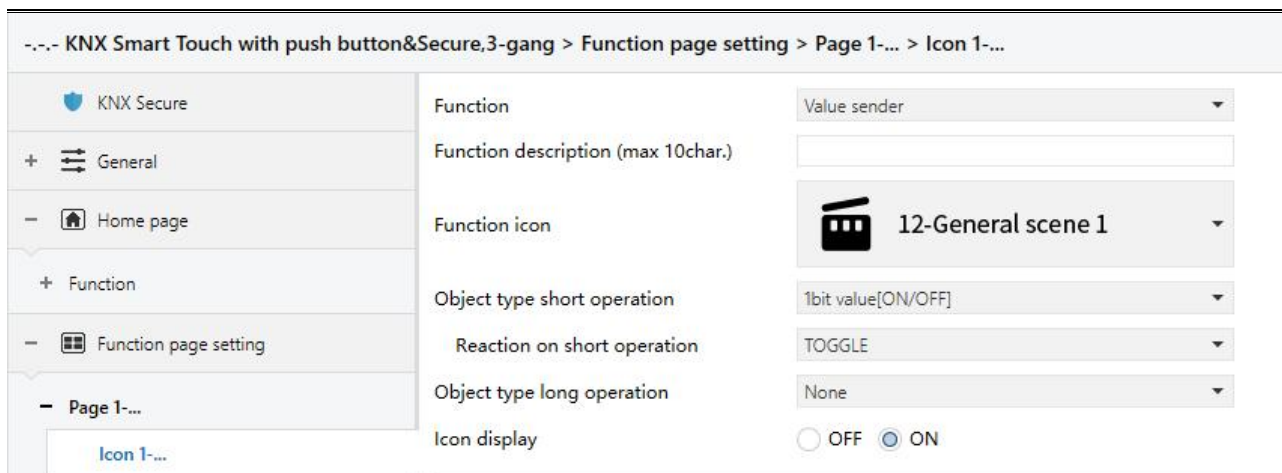

Fig.5.7.2.1 (6) Parameter setting of value sender

Parameter "Object type short operation"

Parameter "Object type long operation"

These two parameters are for setting the sending datatype when the button is in a short / long operation.

Options:

- None**
- 1bit value[ON/OFF]**
- 2bit/4bit value**
- 1byte value[0..255]**
- 2byte value[0..65535]**
- 2byte float value**
- 4byte value[0..4294967295]**
- 4byte float value**

—Parameter "Object datatype"

This parameter is visible when select "2bit/4bit value". Set the datatype 2bit or 4bit. Options:

- 2bit value[0..3]**
- 4bit value[0..15]**

Parameter "Reaction on short operation"

Parameter "Reaction on long operation"

These two parameters are for setting the sending data value when perform short/long operation. Value range is according to the datatype selected by previous parameter.

When select 1 bit, options:

OFF

ON

TOGGLE

When select 2bit/4bit/1byte/2byte/4byte, options:

Value 1

Alternating Value1/Value2

—Parameter "Value 1"

This parameter is visible when 2bit/4bit/1byte/2byte is selected. Set the sending value 1 when perform short/long operation. Options are according to the object datatype: **0~3 / 0..15 / 0..255 / 0..65535 / -670760~670760 / 0~4294967295 / -3.40...~3.40...**

—Parameter "Value 2"

This parameter is visible when 2bit/4bit/1byte/2byte/4byte is selected, and "Alternating Value1/Value2". Set the sending value 2 when perform short/long operation. Options are according to the object datatype: **0~3 / 0..15 / 0..255 / 0..65535 / -670760~670760 / 0~4294967295 / -3.40...~3.40...**

Parameter "Icon display"

This parameter is for set the indication status of the icon on the screen. Options:

OFF

ON

Note: this function is not supported to the dynamic effect.

7. Scene function

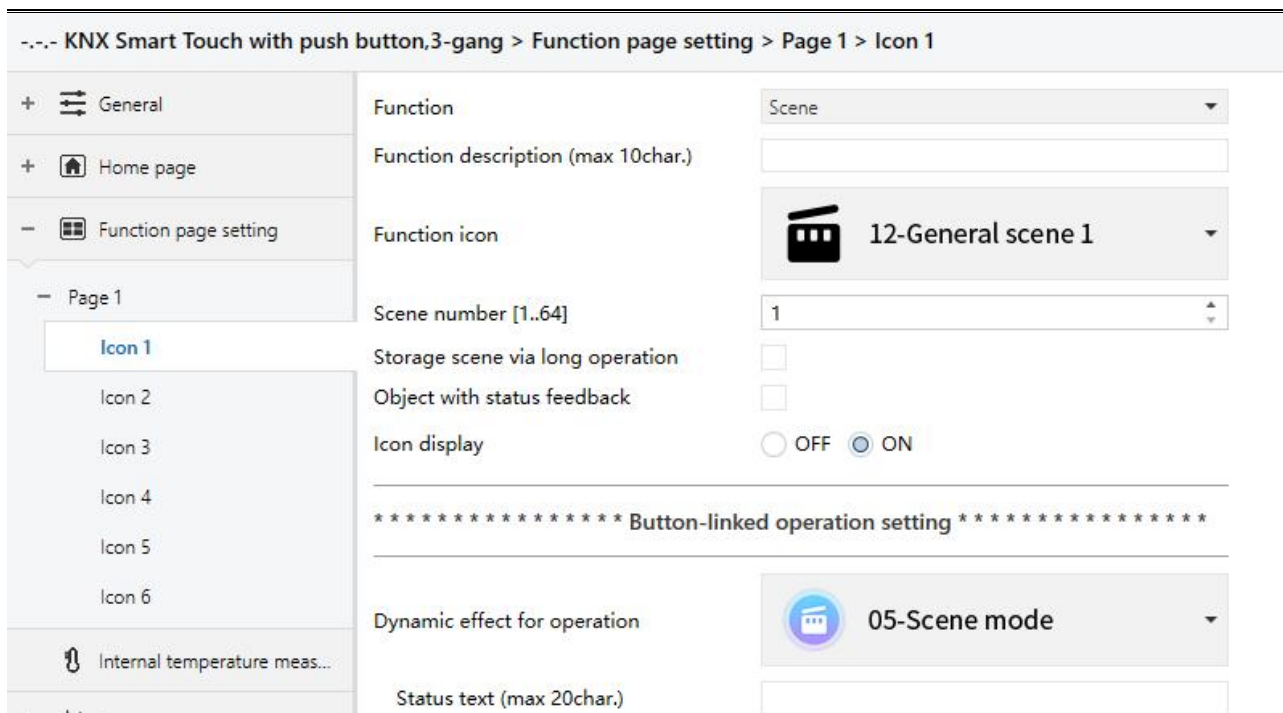

Fig.5.7.2.1 (7) Parameter setting of scene function

Parameter "Scene number [1..64]"

This parameter is for setting the scene number. Options: **1..64**

Parameter "Storage scene via long operation"

This parameter is for setting whether to storage scene via long operation.

Short press to recall scene, long operation optionally determines whether to storage the scene, only occupy 1 button when link to the Mechanical key.

Parameter "Object with status feedback"

This parameter is for setting whether to support the object with status feedback.

Parameter "Icon display"

This parameter is visible when previous parameter is disabled. Set the indication status of the icon on the screen. Options:

OFF

ON

These parameters as follow used for dynamic setting of Scene function.

Parameter "Dynamic effect when button-linked operation"

This parameter is for setting the dynamic icon linked to scene function when the buttons are used as a customized shortcut key for touch screen functions. Options:

Disable

01-Lighting switch

02-Lighting dim

...

16-Romantic

The default icons corresponding to the function and the icons corresponding to the options are described in the appendix.

—Parameter "Status text (max 20char.)"

This parameter is visible when previous parameter enabled. Set the status text for scene.

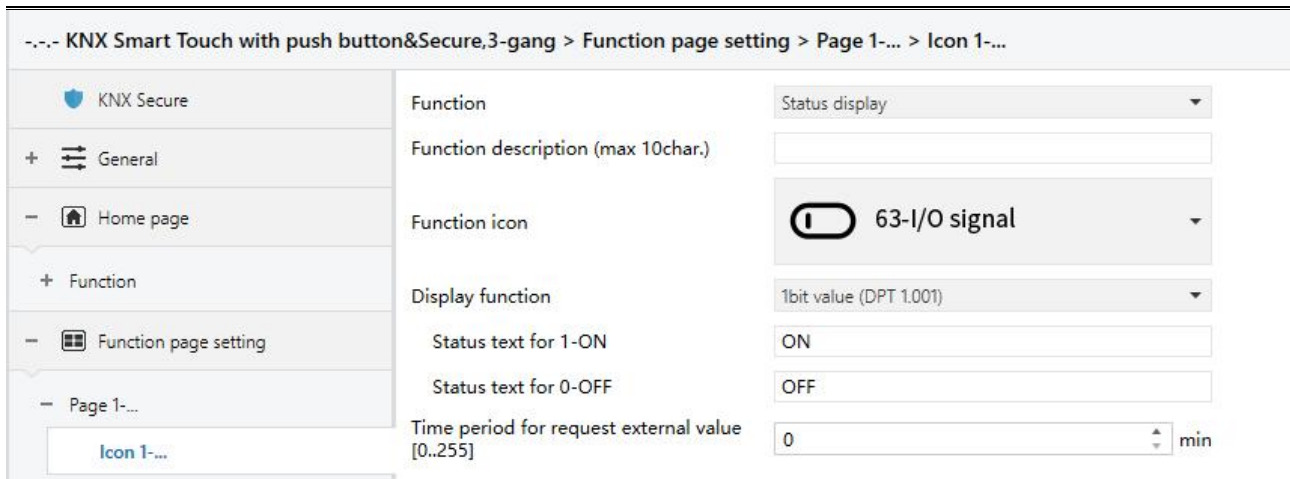

Fig.5.7.2.1(8) Parameter setting of status display

Parameter "Display function"

This parameter is for setting the object datatype for status display function. Options:

- Int. temperature value (DPT 9.001)**
- Int. humidity value (DPT 9.007)**
- Ext. temperature value (DPT 9.001)**
- Ext. humidity value (DPT 9.007)**
- 1bit value (DPT 1.001)**
- 1byte percent value (DPT 5.001)**
- 1byte unsigned value (DPT 5.010)**
- 2byte unsigned value (DPT 7.001)**
- 2byte lux value (DPT 9.004)**
- 2byte float value (DPT 9.x)**

—Parameter "Status text for 1-ON"

—Parameter "Status text for 0-OFF"

These parameters are visible when 1 bit is selected. Set the status text for ON and OFF.

—Parameter "Text for unit"

This parameter is visible when 1byte unsigned value or 2byte is selected. Set the text for display unit.

Parameter "Time period for request external value [0...255]min"

This parameter is visible when external sensor is selected. Set the time period for device to send a control value read request to external sensor after bus recovery or finish programming. Options: **0..255**

Note: Data of this device does not support to be requested.

Parameter "Icon display"

These parameters are visible when 1 bit is not selected. Set the indication status of the icon on the screen. Options:

OFF

ON

5.7.2.2.Parameter of air condition

--- KNX Smart Touch with push button&Secure,3-gang > Function page setting > Page 1-... > Icon 1-...

<ul style="list-style-type: none"> KNX Secure + General - Home page + Function - Function page setting <ul style="list-style-type: none"> - Page 1-... <ul style="list-style-type: none"> + Icon 1-... Icon 2-... Icon 3-... Icon 4-... Icon 5-... Icon 6-... Internal temperature measurement + Input + HVAC controller + Button + Logic function + Scene group function 	<p>Function: Air conditioner</p> <p>Function description (max 10char.):</p> <p>Function icon: 66-Air conditioner 1</p> <p>Interface display temperature: <input type="radio"/> Setpoint temperature <input checked="" type="radio"/> Actual temperature</p> <p>Room temperature reference from: <input checked="" type="radio"/> Internal sensor <input type="radio"/> External sensor</p> <hr/> <p>Object datatype of setpoint: <input type="radio"/> Value in °C (DPT_5.010) <input checked="" type="radio"/> Float value in °C (DPT_9.001)</p> <p>Setpoint temperature adjustment step: <input type="radio"/> 0.5K <input checked="" type="radio"/> 1K</p> <p>Min. setpoint temperature [16..32]: 16 °C</p> <p>Max. setpoint temperature [16..32]: 32 °C</p> <hr/> <p>Vanes swing: <input checked="" type="checkbox"/></p> <p>Timer: <input checked="" type="checkbox"/></p> <p>Scene: <input checked="" type="checkbox"/></p> <p>Send delay between telegrams: 100ms</p> <hr/> <p>Protection setting</p> <p>ON/OFF protection: <input checked="" type="checkbox"/></p> <p>Setpoint protection: <input checked="" type="checkbox"/></p> <p>Control mode protection: <input checked="" type="checkbox"/></p> <p>Fan protection: <input checked="" type="checkbox"/></p> <p>Vanes swing protection: <input checked="" type="checkbox"/></p>
--	--

Fig.5.7.2.2(1) Air condition parameter window

Parameter "Interface display temperature"

This parameter is for setting the interface display temperature under the normal status. Options:

Setpoint temperature

Actual temperature

Note: If display room temperature, only switch to display setpoint temperature when firstly operate temperature increase/decrease button, and not send telegram.

Parameter "Room temperature reference from"

This parameter is for setting the resource of the air condition function temperature reference.

Options:

Internal sensor

External sensor

—Parameter "Time period for request room temperature sensor [0...255]min"

This parameter is visible when "External sensor" is selected. Set the time period for read request external temperature sensor. Options: **0..255**

Note: Send read request as default when the device voltage recovery.

Parameter "Object datatype of setpoint"

This parameter is for setting the object datatype of setpoint temperature. Options:

Value in °C (DPT_5.010)

Int, data of actual temperature

Float value in °C (DPT_9.001)

Float, data of standard KNX temperature

Parameter "Setpoint temperature adjustment step"

This parameter is for setting step value of setpoint temperature. Options display according to datatype:

0.5K

1K

When select "Value in °C (DPT_5.010)", only **1K**

Parameter "Min./Max. setpoint temperature [16..32]°C"

These parameters are for setting the adjustable range of the setpoint temperature, the minimum value should be less than the maximum value. If the setpoint temperature beyond the limited range, the

will output the limited temperature. Options:

16°C

17°C

...

32°C

Parameter "Vanes swing"

This parameter is for setting whether to enable vanes swing function, display corresponding object when enable.

Parameter "Timer"

This parameter is for setting whether to enable timer function, display corresponding object when enable. User can set the time on the screen.

Note: The bus only disable timer function temporarily.

Parameter "Scene"

This parameter is for setting whether to enable scene function, display corresponding object and setting window when enable. Link to power on/off, mode, fan speed, setpoint temperature.

—Parameter "Send delay between telegrams"

This parameter is visible when scene function enabled. Set the delay time between the sending telegrams. Options:

Disable

100ms

300ms

500ms

Protection setting

Parameter "ON/OFF protection"

Parameter "Setpoint protection"

Parameter "Mode protection"

Parameter "Fan protection"

Parameter "Vanes swing protection"

These parameters are for setting to whether to enable protection function, that is some functions only display and disable user to operate. Protection function support to ON/OFF, setpoint value, mode, fan speed control, swing control.

For protection function, user can not operate screen or shortcut button, but still process received status.

Setting window of air condition mode

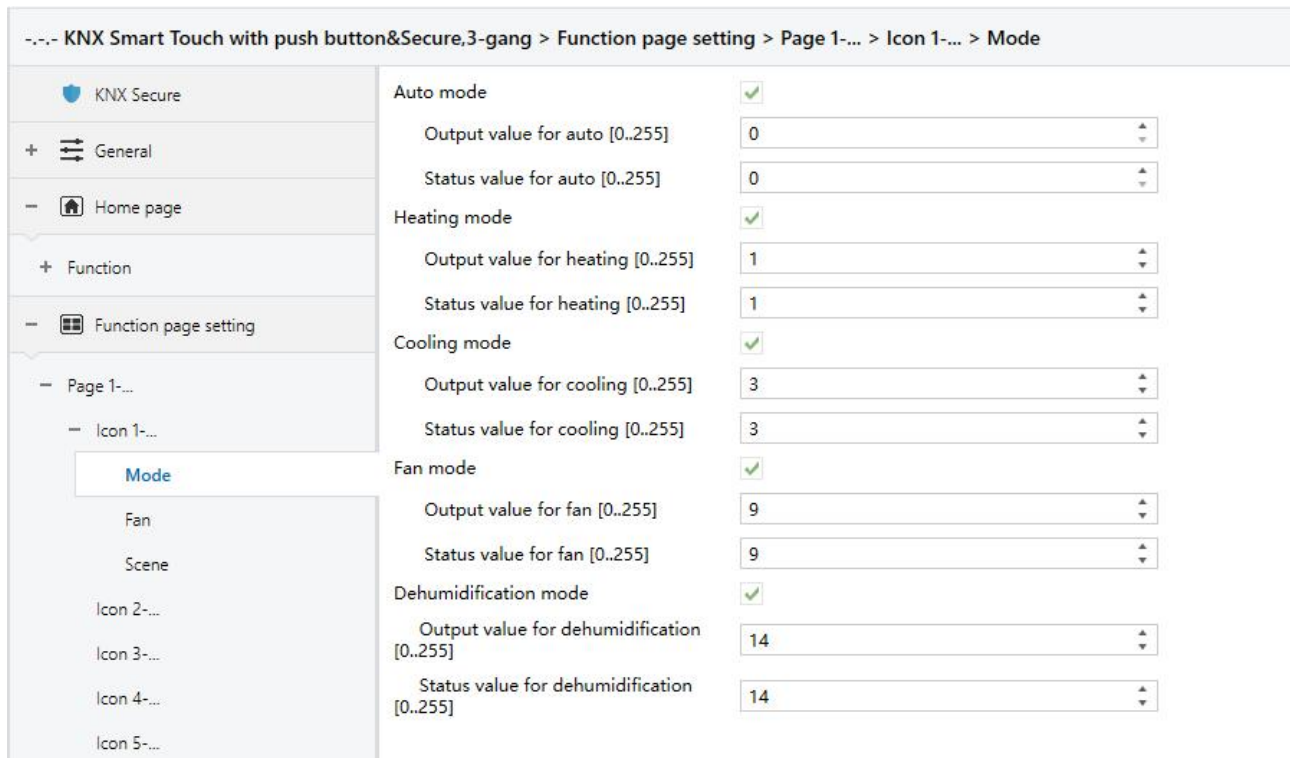

Fig.5.7.2.2(2) Air condition-Mode parameter window

Parameter "Auto/Heating/Cooling/Fan/Dehumidification mode"

Corresponding setting parameters are visible when this parameter enabled.

Parameter "Output value for auto/heating/cooling/fan/dehumidification [0..255]"

These parameters are visible when modes enabled. Set the output value of each mode. Options:

0..255

Parameter "Status value for auto/heating/cooling/fan/dehumidification [0..255]"

These parameters are visible when modes enabled. Set the status feedback value of each mode.

Options: **0..255**

Setting window of air condition fan speed

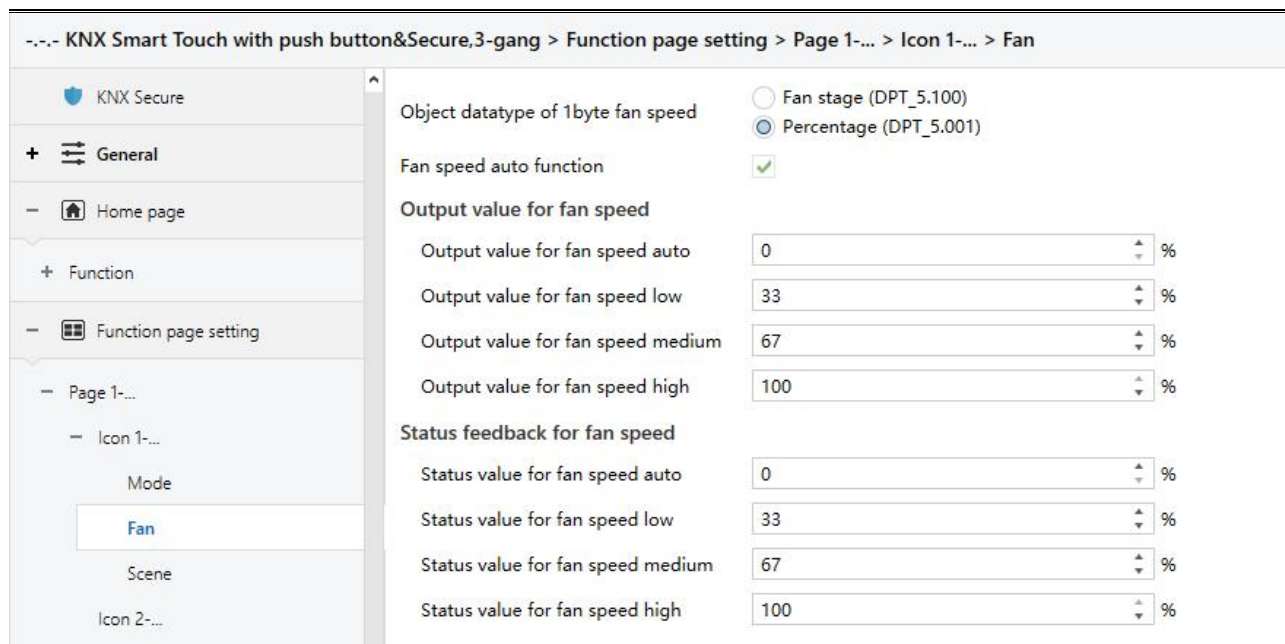

Fig.5.7.2.2(3) Air condition-Fan speed parameter window

Parameter "Object datatype of 1byte fan speed"

This parameter is for setting the object datatype of 1 byte fan speed. Options:

Fan stage (DPT 5.100)

Percentage (DPT 5.001)

Parameter "Fan speed auto function"

This parameter is for setting whether to enable fan speed auto function, display corresponding object and parameter when enable.

Output value for fan speed

Parameter "Output value for fan speed auto/low/medium/high"

These parameters are for setting the value sent for each fan speed switchover, support 4 fan speeds auto, low, medium, high. Options according to fan object datatype: **0..255/0..100**

Status feedback for fan speed

Parameter "Status value for fan speed auto/low/medium/high"

These parameters are for setting the status feedback value for each fan speed, support 4 fan speeds auto, low, medium, high. Device updates display according to feedback value. Options according to fan object datatype: **0..255/0..100**

Setting window of air condition scene, visible when scene function enabled

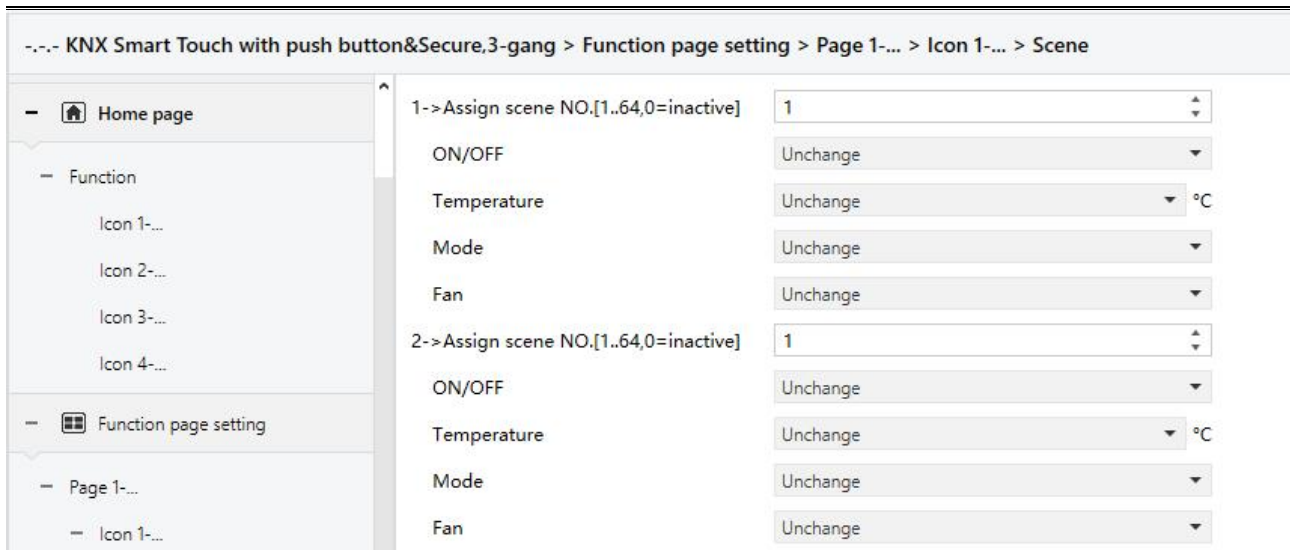

Fig.5.7.2.2(4) Air condition-Scene parameter window

Parameter "x->Assign scene NO. [1..64,0=inactive]" (x=1~5)

This parameter is for setting the triggered scene number. Up to support 5 triggered scenes.

Options: **0..64, 0=inactive**

Parameter "ON/OFF"

This parameter is for setting status of ON/OFF. Options:

- Unchange**
- OFF**
- ON**

Three parameters as follow are not visible when OFF is selected.

Parameter "Temperature"

This parameter is for setting the status of setpoint temperature. Options:

- Unchange**
- 16°C**
- 17°C**
- ..**
- 32°C**

— Parameter "Mode"

This parameter is for setting the status of mode. Options:

Unchange

Auto

Heating

Cooling

Fan

Temperature

— Parameter "Fan"

This parameter is for setting the status of fan speed. Options:

Unchange

Auto

Low

Medium

High

Note: ON/OFF, temperature, mode and fan speed send in order. If not finish during delay time and have a new command, perform the new one. Unperformed operations are ignored.

5.7.2.3.Parameter of room temperature unit

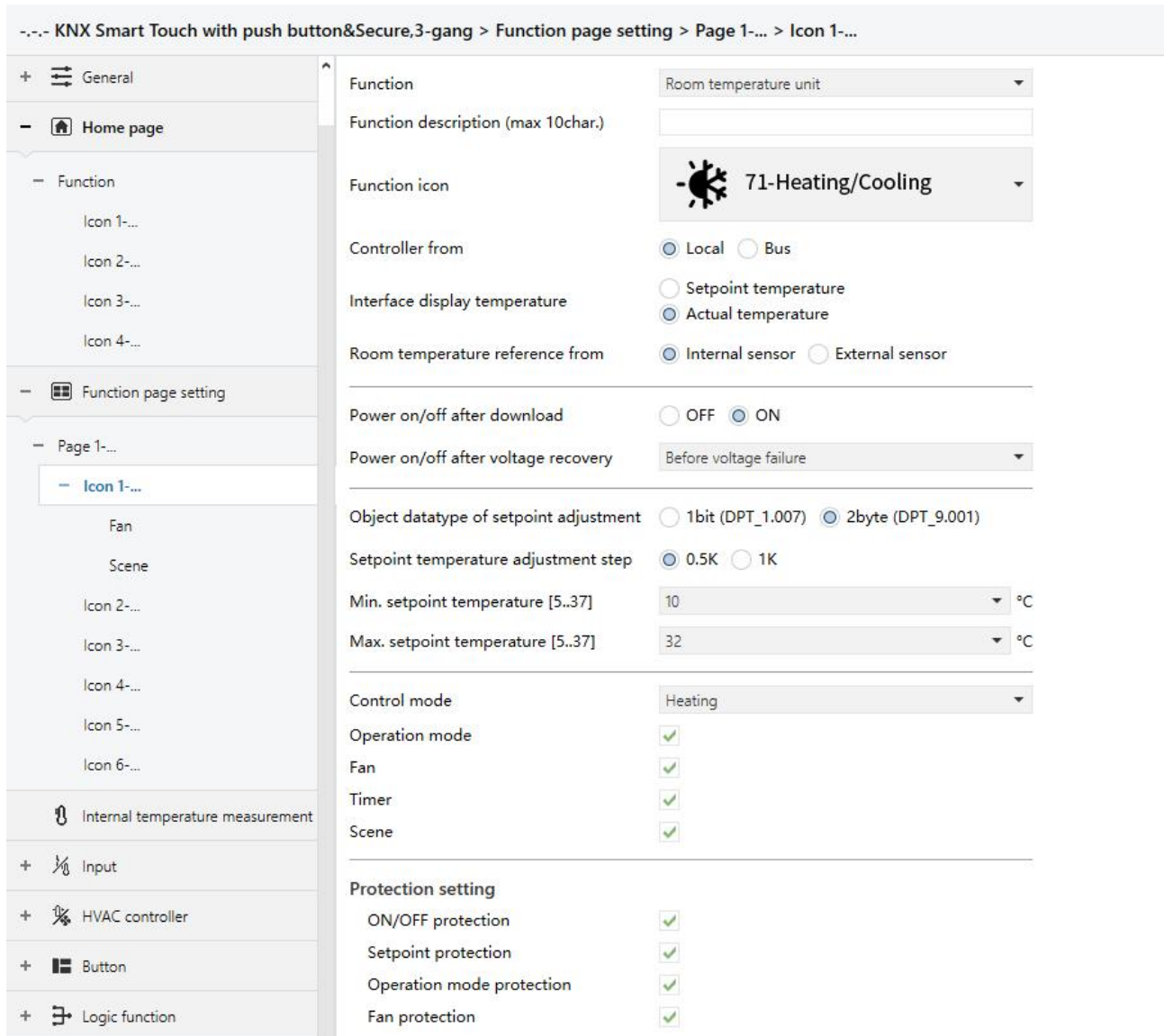

Fig.5.7.2.3(1) room temperature unit function parameter window

参数“Controller from”

This parameter is for setting the controller is from the local or bus. If select the local controller, it no need to send the read request of the setting temperature, control mode and operation mode when power on or bus recovery (because the device cannot respond to its own request). Options:

Local

Bus

Parameter “Interface display temperature”

This parameter is for setting the interface display temperature under the normal status. Options:

Setpoint temperature

Actual temperature

Note: If display room temperature, only switch to display setpoint temperature when firstly operate temperature increase/decrease button, and not send telegram.

Parameter "Room temperature reference from"

This parameter is for setting the resource of the temperature reference. Options:

Internal sensor

External sensor

—Parameter "Time period for request room temperature sensor [0...255]min"

This parameter is visible when "External sensor" is selected. Set the time period for read request external temperature sensor. Options: **0..255**

Note: Send read request as default when the device voltage recovery.

Parameter "Power on/off after download "

This parameter is for setting the power on/off status of RTC interface after download. Options:

OFF

ON

Parameter "Power on/off after voltage recovery"

This parameter is for setting the power on/off status of RTC interface after device voltage recovery.

Options:

OFF

ON

Before voltage failure

On: Device will power on when voltage recovery, this interface can be operated;

Off: Device will power off when voltage recovery, this interface can not be operated;

Before voltage failure: Device will return to the power status as before voltage failure when voltage recovery.

Parameter "Object datatype of setpoint adjustment"

This parameter is for setting the object datatype of setpoint temperature. Options:

1bit (DPT_1.007)

Float value in °C (DPT_9.001)

Parameter "Setpoint temperature adjustment step"

This parameter is visible when "Value in °C (DPT_5.010) " is selected. Set the step value of setpoint temperature. Options:

0.5K

1K

Parameter "Min. /Max. setpoint temperature [5..37]°C"

These parameters are for setting the adjustable range of the setpoint temperature, the minimum value should be less than the maximum value. If the setpoint temperature beyond the limited range, the will output the limited temperature.

Parameter "Control mode"

This parameter is for setting the RTC control mode. Options:

Heating

Cooling

Heating and Cooling

Parameter "Operation mode"

This parameter is for setting whether to enable room operation mode, display corresponding objects when enable. Support 4 modes comfort, standby, economy, protection.

Parameter "Fan "

This parameter is for setting whether to enable fan control, display corresponding objects and the setting window when enable.

Parameter "Timer"

This parameter is for setting whether to enable timer function, display corresponding object when enable. User can set the time on the screen.

Note: The bus only disable timer function temporarily.

Parameter "Scene"

This parameter is for setting whether to enable scene function, display corresponding object and

setting window when enable. Link to power on/off, operate mode, setpoint temperature.

Protection setting

Parameter "ON/OFF protection"

Parameter "Setpoint protection"

Parameter "Control mode protection"

Parameter "Operation mode protection"

Parameter "Fan protection"

These parameters are for setting to whether to enable protection function, that is some functions only display and disable user to operate. Protection function support to ON/OFF, setpoint value, control mode, operation mode, fan speed control.

For protection function, user can not operate screen or shortcut button, but still process received data.

Setting window of RTC fan speed, visible when fan speed function enabled

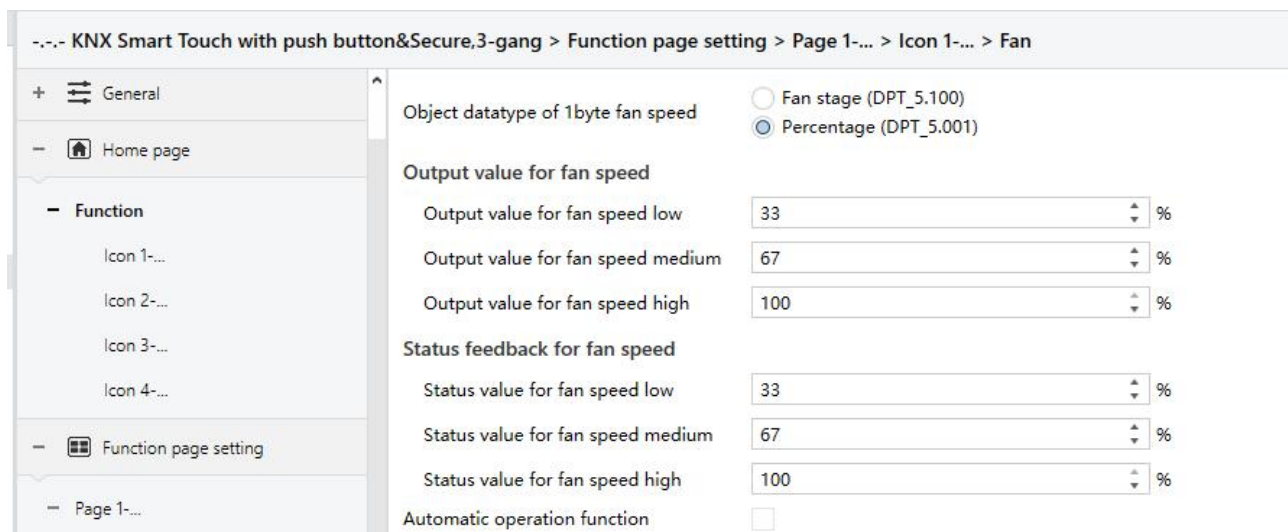

Fig.5.7.2.3(2) RTC -Fan speed parameter window

Parameter "Object datatype of 1byte fan speed"

This parameter is for setting the object datatype of 1 byte fan speed. Options:

Fan stage (DPT 5.100)

Percentage (DPT 5.001)

Output value for fan speed

— Parameter "Output value for fan speed low/medium/high"

These three parameters are for setting the value sent for each fan speed switchover, support 3 fan speeds low, medium, high. Options according to fan object datatype: **0..255/0..100**

Status feedback for fan speed

— Parameter "Status value for fan speed low/medium/high"

These parameters are for setting the status feedback value for each fan speed, support 3 fan speeds low, medium, high. Device updates display according to feedback value. Options according to fan object datatype: **0..255/0..100**

Parameter "Automatic operation function"

This parameter is for setting whether to enable fan speed auto function, display corresponding object when enable.

Setting window of RTC scene, visible when scene function enabled

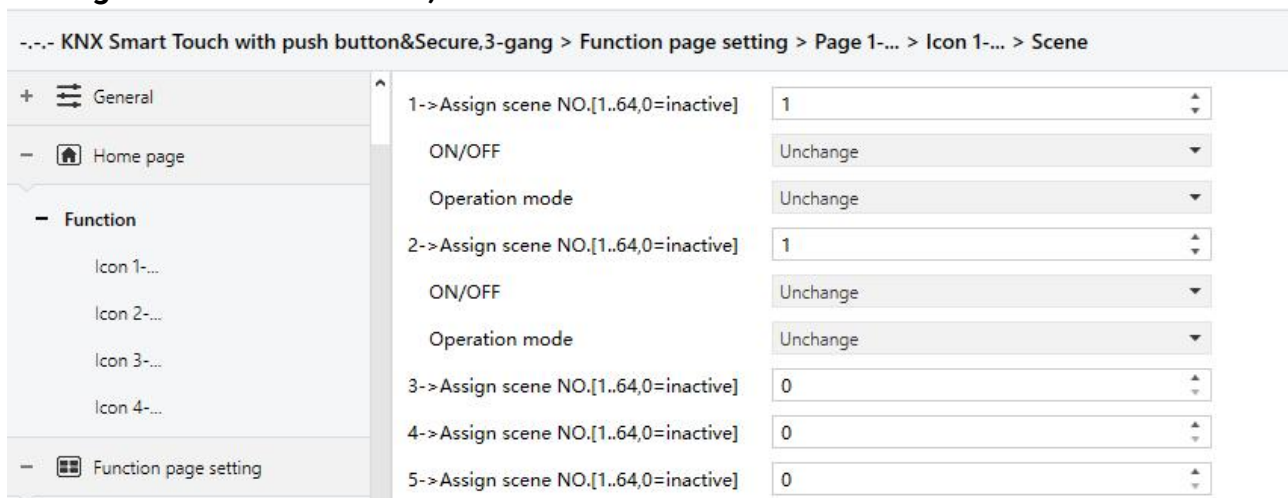

Fig.5.7.2.3(3) RTC-Scene parameter window

Parameter "x->Assign scene NO.[1..64,0=inactive]"(x=1~5)

This parameter is for setting the triggered scene number. Up to support 5 triggered scenes. Options: **0..64, 0=inactive**

— Parameter "ON/OFF"

This parameter is for setting status of ON/OFF. Options:

Unchange

OFF

ON

— Parameter "Temperature"

This parameter is visible when operation mode disabled. Set the status of setpoint temperature.

Options:

Unchange=0

5°C

6°C

..

37°C

— Parameter "Operation mode"

This parameter is visible when operation mode enabled. Set the status of operation mode. Option:

Unchange

Comfort mode

Standby mode

Economy mode

Frost/heat protection

5.7.2.4. Parameter of ventilation system

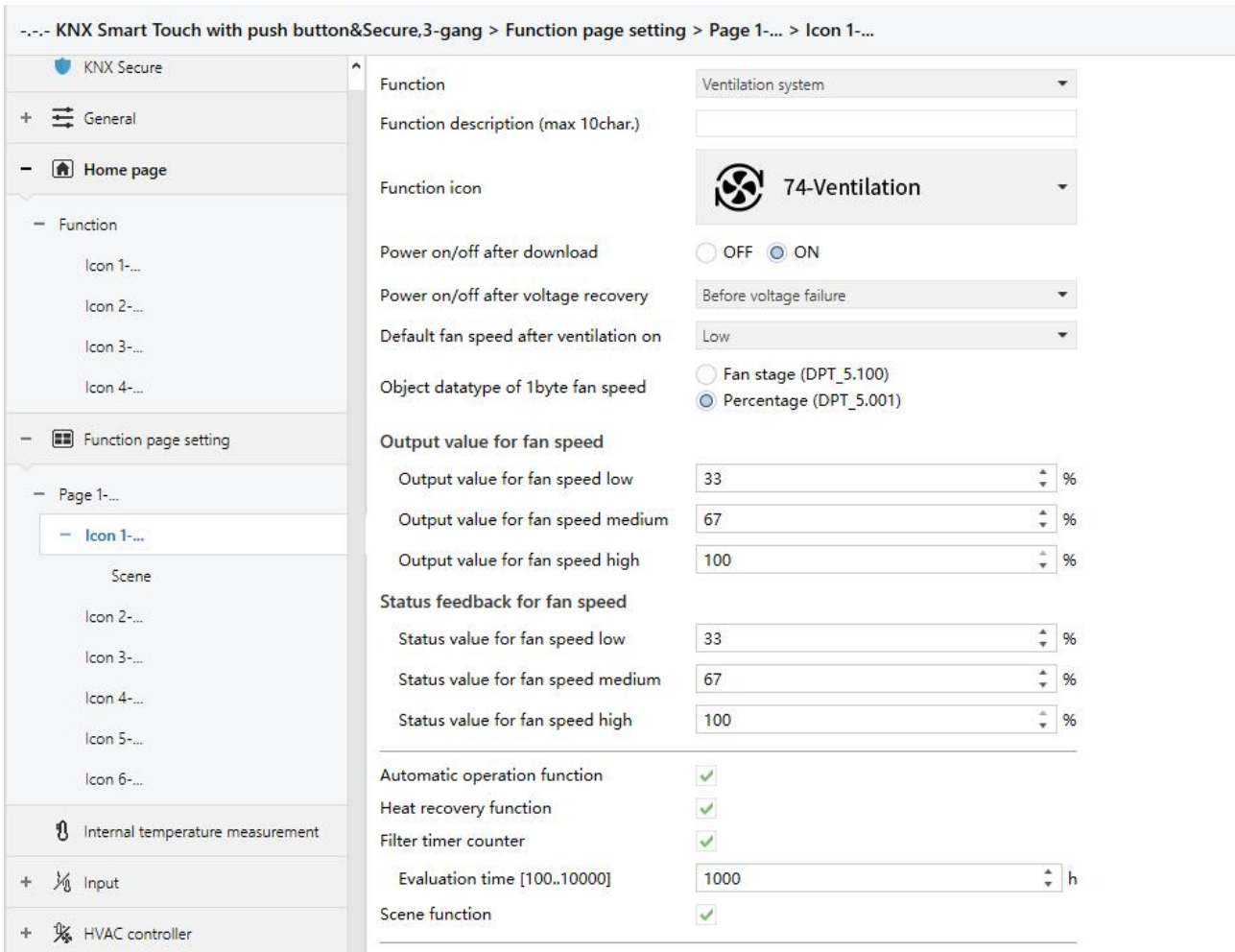

Fig.5.7.2.4 Ventilation system function parameter window

Parameter "Power on/off after download"

This parameter is for setting the power on/off status of ventilation system interface after download. Options:

OFF

ON

Parameter "Power on/off after voltage recovery"

This parameter is for setting the power on/off status of ventilation system interface after device voltage recovery. Options:

OFF

ON

Before voltage failure

On: Device will power on when voltage recovery, this interface can be operated;

Off: Device will power off when voltage recovery, this interface can not be operated, except for the icons of filter reset and power ON/OFF;

Before voltage failure: Device will return to the power status as before voltage failure when voltage recovery.

Parameter "Default fan speed after ventilation on"

This parameter is for setting the initial fan speed after power on. Options:

Low

Medium

High

Last status

Parameter "Object datatype of 1byte fan speed"

This parameter is for setting the object datatype of 1 byte fan speed. Options:

Fan stage (DPT 5.100)

Percentage (DPT 5.001)

Output value for fan speed

Parameter "Output value for fan speed low/medium/high"

These three parameters are for setting the value sent for each fan speed switchover, support 3 fan speeds low, medium, high. Options according to fan object datatype: **0..255/0..100**

Status feedback for fan speed

Parameter "Status value for fan speed low/medium/high"

These parameters are for setting the status feedback value for each fan speed, support 3 fan speeds low, medium, high. Device updates display according to feedback value. Options according to fan object datatype: **0..255/0..100**

Parameter "Automatic operation function"

This parameter is for setting whether to enable fan speed auto function, display corresponding object when enable.

Parameter "Heat recovery function"

This parameter is for setting whether to enable heat recovery function, display corresponding object when enable.

Parameter "Filter timer counter"

This parameter is for setting whether to enable heat recovery function, display corresponding object and parameter when enable.

—Parameter "Evaluation time [100..10000]h"

This parameter is for setting the service life of the filter. Options: **100..10000**

If the filter takes longer than the setting time, the filter will send an alarm and prompt to clean the filter.

The life length of the filter can be reset through the object "Filter timer reset".

The life length of the filter can be counted by the object "Filter timer counter". The counting duration is in hours. The counting value will be sent to the bus when it has changed, and the counting duration of filter can be modified by object "Filter timer counter change" through the bus.

Parameter "Scene function"

This parameter is for setting whether to enable scene function, display corresponding object and setting window when enable. Link to fan speed, heat recovery.

Setting window of ventilation system scene, visible when scene function enabled

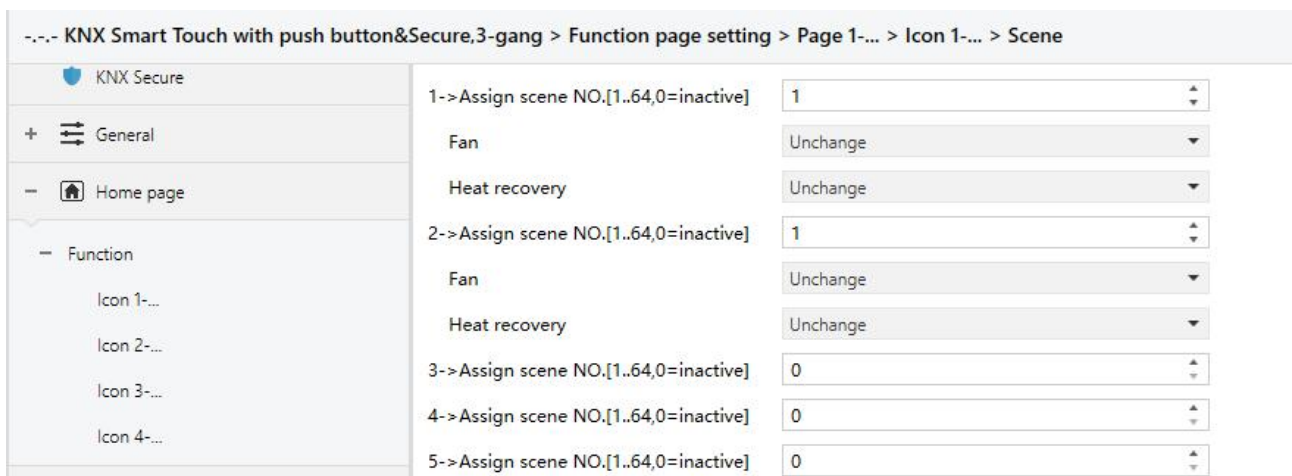

Fig.5.7.2.4(2) Ventilation system-scene parameter window

Parameter "x->Assign scene NO.[1..64,0=inactive]"(x=1~5)

This parameter is for setting the triggered scene number. Up to support 5 triggered scenes.

Options: **0..64, 0=inactive**

——Parameter "Fan"

This parameter is for setting status of fan speed. Options:

Unchange

OFF

Low

Medium

High

Parameter as follow is not visible when OFF is selected.

——Parameter "Heat recovery"

This parameter is visible when heat recovery function enabled. Set status of heat recovery.

Options:

Unchange

OFF

ON

5.7.2.5. Parameter of audio control

--- KNX Smart Touch with push button&Secure,3-gang > Function page setting > Page 1-... > Icon 1-...

<ul style="list-style-type: none"> KNX Secure General Home page Function <ul style="list-style-type: none"> Icon 1-... Icon 2-... Icon 3-... Icon 4-... Function page setting <ul style="list-style-type: none"> Page 1-... <ul style="list-style-type: none"> Icon 1-... Icon 2-... Icon 3-... Icon 4-... Icon 5-... Icon 6-... Internal temperature measurement Input HVAC controller Button 	<p>Function: Audio control</p> <p>Function description (max 10char.):</p> <p>Function icon: 72-Music 1</p> <p>Power on/off: <input checked="" type="checkbox"/></p> <p>Power on/off status after download: <input checked="" type="radio"/> OFF <input type="radio"/> ON</p> <p>Power on/off status after voltage recovery: OFF</p> <p>Number of object for play/pause control: <input checked="" type="radio"/> One object <input type="radio"/> Two objects</p> <p>Control mode of volume adjustment: <input checked="" type="radio"/> 1Bit (relative control) <input type="radio"/> 1Byte (absolute control)</p> <p>Mute: <input type="checkbox"/></p> <p>Track name: <input type="checkbox"/></p> <p>Artist name: <input type="checkbox"/></p> <p>Album name: <input type="checkbox"/></p> <hr/> <p>Play mode: <input checked="" type="checkbox"/></p> <p>Play in single cycle mode: <input checked="" type="checkbox"/></p> <p>Output value for play in single cycle: 1</p> <p>Status value for play in single cycle: 1</p> <p>Play in order mode: <input checked="" type="checkbox"/></p> <p>Output value for play in order: 2</p> <p>Status value for play in order: 2</p> <p>Play in random mode: <input checked="" type="checkbox"/></p> <p>Output value for play in random: 3</p> <p>Status value for play in random: 3</p>
---	---

Fig.5.7.2.5 Audio control function parameter window

Parameter "Power on/off"

This parameter is for setting whether to activate the function to power on/off. Icon of power on/off on the screen is not visible when disabled.

Parameter "Power on/off after download"

This parameter is for setting the power on/off status of audio control interface after download.

Options:

OFF

ON

Parameter "Power on/off after voltage recovery"

This parameter is for setting the power on/off status of audio control interface after device voltage recovery. Options:

OFF

ON

Before voltage failure

On: Device will power on when voltage recovery, this interface can be operated;

Off: Device will power off when voltage recovery, this interface can not be operated;

Before voltage failure: Device will return to the power status as before voltage failure when voltage recovery.

Parameter "Number of object for play/pause control"

This parameter is for setting the number of objects that control play/pause, 1 common object or 2 separate objects. Options:

One object

Two objects

Parameter "Control mode of volume adjustment"

This parameter is for setting the datatype of volume adjustment. Options:

1Bit (relative control)

1Byte (absolute control)

When select 1 bit, support to increase/decrease and mute volume function; When select 1 byte, only support to 1 byte object to adjust volume, and set the maximum volume.

——Parameter "Object datatype"

This parameter is visible when 1 byte is selected. Set the datatype of 1 byte object. Options:

Percentage (DPT 5.001)

Percentage (DPT 5.004)

—Parameter "Max. volume value [10..100]%"

This parameter is visible when 1 byte is selected. Set the maximum volume value. Options: **10..100**

Parameter "Mute"

This parameter is visible when 1 bit is selected. Set whether to enable mute function.

Parameter "Track name"

This parameter is for setting whether to display the track name.

Note: The encode data of track name telegram is associated with interface language, when it is selected Simplified Chinese, use UTF-8; while other languages, use ISO8859. The telegrams of artist name and album name are the same.

Parameter "Artist name"

This parameter is for setting whether to display the artist name.

Parameter "Album name"

This parameter is for setting whether to display the album name.

Parameter "Play mode"

This parameter is for setting whether to enable play mode, display the parameters as follow when enable.

—Parameter "Play in single cycle mode"

This parameter is for setting whether to enable play in single cycle mode. Display two parameters as follow when enable.

—Parameter "Output value for play in single cycle"

This parameter is for setting the output value for play in single cycle. Options: **0..255**

—Parameter "Status value for play in single cycle"

This parameter is for setting the status value for play in single cycle. Device will update the play mode displayed on the screen according to the feedback value. Options: **0..255**

—Parameter “Play in order mode”

This parameter is for setting whether to enable play in order mode. Display two parameters as follow when enable.

—Parameter “Output value for play in order”

This parameter is for setting the output value for play in order. Options: **0..255**

—Parameter “Status value for play in order”

This parameter is for setting the status value for play in order. Device will update the play mode displayed on the screen according to the feedback value. Options: **0..255**

—Parameter “Play in random mode”

This parameter is for setting whether to enable play in random mode. Display two parameters as follow when enable.

—Parameter “Output value for play in random”

This parameter is for setting the output value for play in random. Options: **0..255**

—Parameter “Status value for play in random”

This parameter is for setting the status value for play in random. Device will update the play mode displayed on the screen according to the feedback value. Options: **0..255**

5.7.2.6.LED indication function

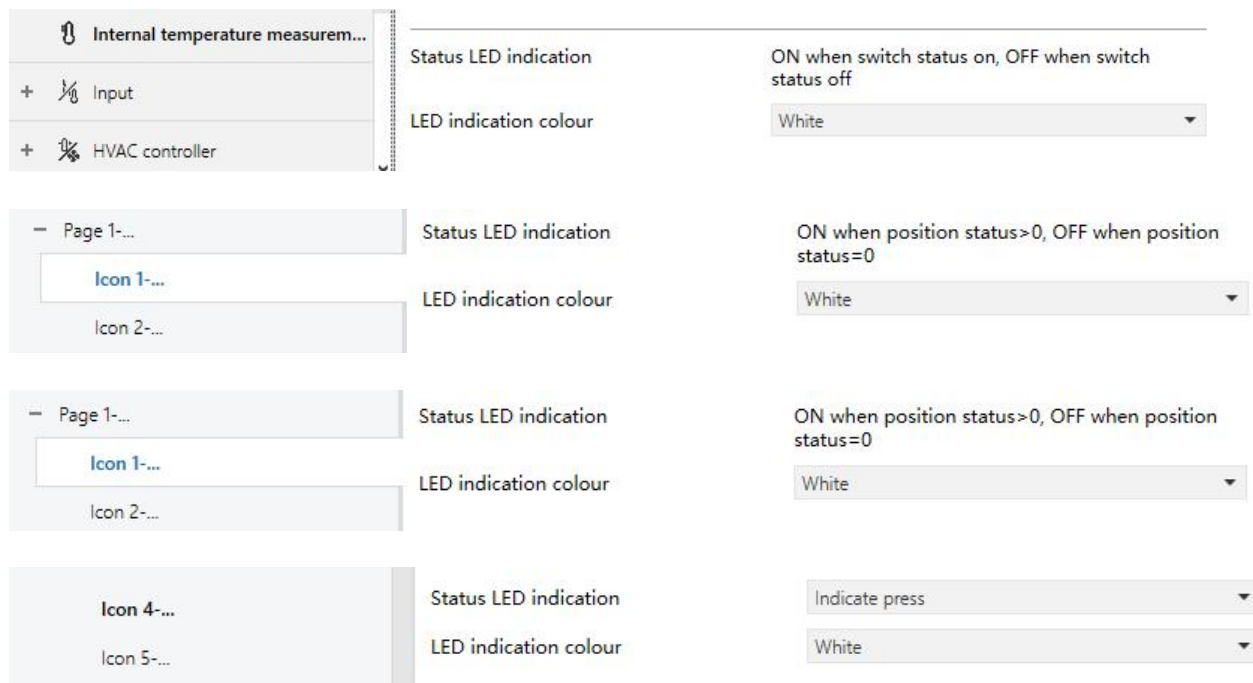

Fig.5.7.2.6 Parameter setting of LED indication function

Parameters as follow is visible when push button panel is set as “Customized linking to touch”.

Each icon can set corresponding LED indication colour independently. When operate button, there are indications as follow:

Parameter “Status LED indication”

This parameter is for setting the status of LED indication, the options is according to different function icon options:

For the function with switch status, LED indication response is according to the indication effect of switch status, as follow:

When function select Switch / Press/release switch / Relative dimming / Brightness dimming / RGB dimming / RGBW dimming / RGBCW dimming / Colour temperature dimming, Read-only by default

ON when switch status on, OFF when switch status off

When function select Curtain position / Roller blind position / Venetian blind position and slat, Read-only by default **ON when position status>0, OFF when position status=0**

When function select Scene and enable the parameter“Object with status feedback”, Read-only by **ON when position status>0, OFF when position status=0**

For the shortcut button without status feedback, such as scene(without status), value sender,

temperature control, air condition, ventilation system and audio control, which behaviour can be set to disable, always on, according to power on/off, indicate press:

When function select Curtain step move / Roller blind step move / Value sender / Scene and disable the parameter“Object with status feedback” / Audio control and disable the parameter“Power on/off”, options:

Disable

Indicate press

Always ON

When function select Air conditioner / Room temperature unit / Ventilation system / Audio control and enable the parameter“Power on/off”, options:

Disable

Indicate press

According to Power on/off

Always ON

Disable: no indication;

According to Power on/off: indication is according to power on/off, only support temperature control, air condition, ventilation system and audio control(with power on/off);

Indicate press: On 3s then off when detect the button is pressed;

Always ON: the LED is always on.

Parameter “LED indication colour”

This parameter is for setting the LED indication colour, and when it is a customized colour, you need to configure the the colour in the “Customized colour” interface.Options:

Red

Orange

Green

Cyan blue

Blue

Customized colour 1

White

Customized colour 2

Yellow

Customized colour 3

Cyan

Customized colour 4

Magenta

Customized colour 5

5.8.Parameter window “Button”

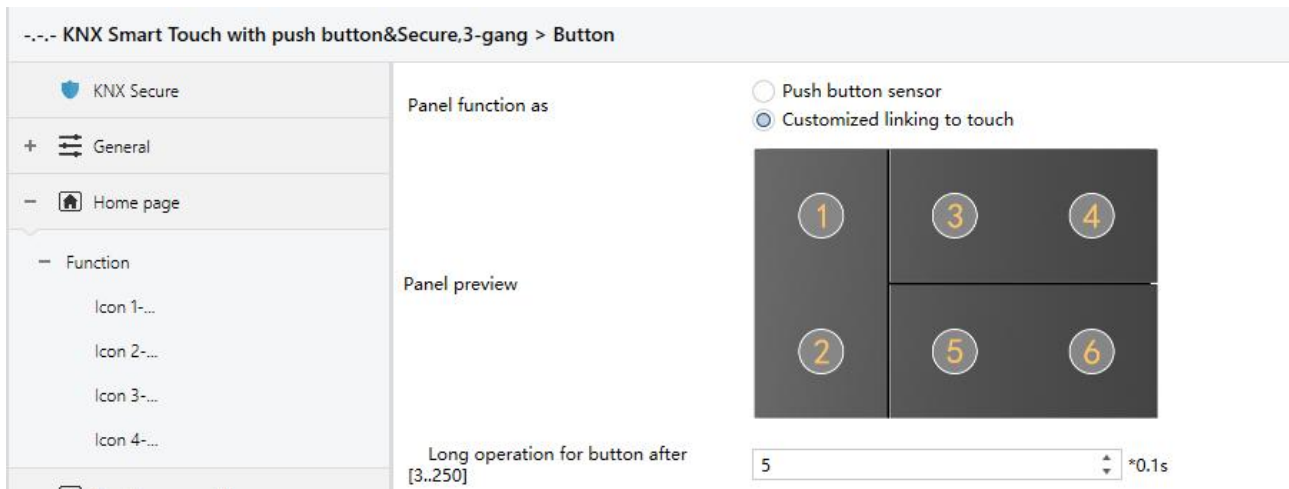

Fig.5.8 “Button” parameter window

Parameter “Panel function as”

This parameter is for setting the function of the button panel. Below the parameter, display the interface interview according to the options. Options:

Push button sensor

Customized linking to touch

Push button sensor: Configurable as a fixed independent function. Support function are configurable: Link to the switch object, external object control (1bit/1byte), operation indication (Flashing and always on, and period time optionally), always on.

Customized linking to touch: Configurable to link to touch function. If link to functions of switch or dimming, only switch status of LED; If link to the functions of value sender, scene. curtain/blind, air condition, the button operation indicates, LED off after on 3s.

Parameter “ Long operation for button after [3..25]*0.1s”

Button operation is distinguished between long and short operation as default, this parameter is for setting the valid time for long operation. So, when you press longer than the time set here, it will be identified as long operation, otherwise, it will be taken as short operation. Options: **3..25**

5.8.1.Button function setting

This chapter is visible when push button panel is set as “Push button sensor”

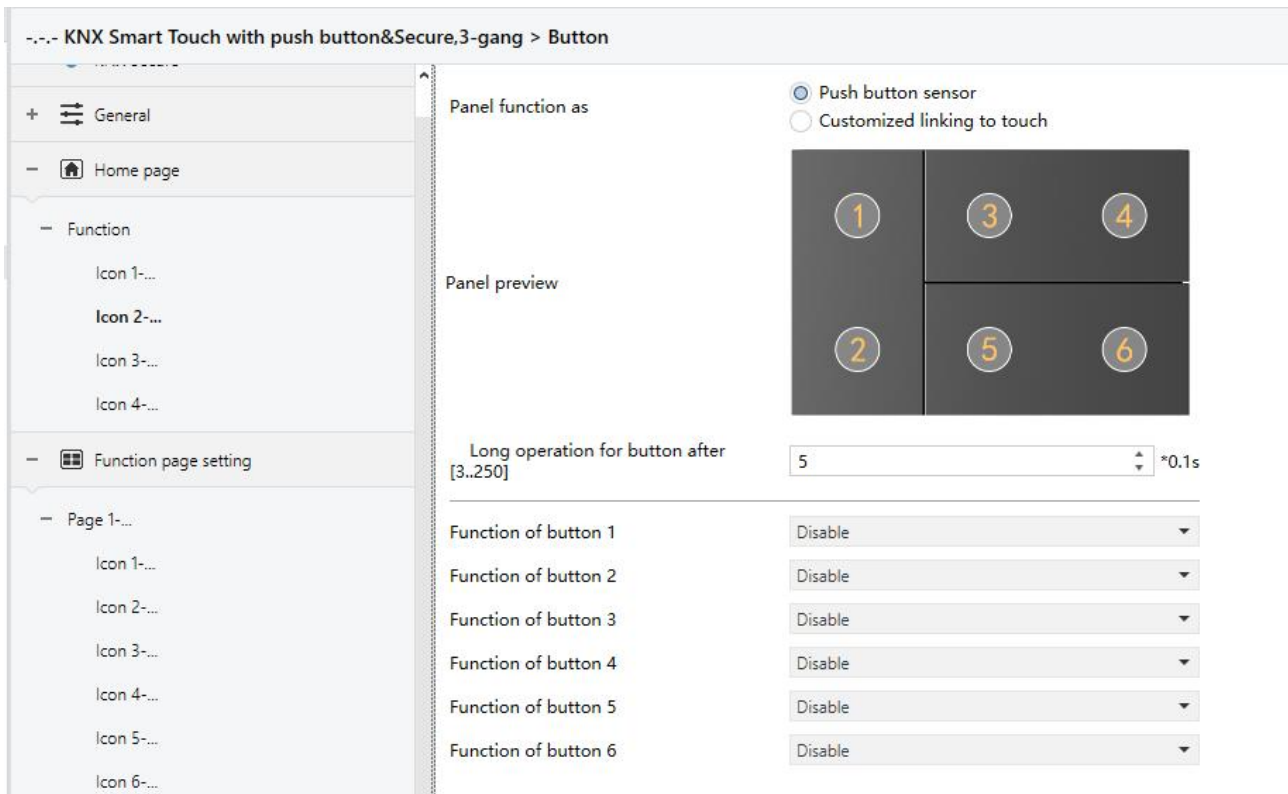

Fig.5.8.1 Parameter setting of button function

Parameter "Function of button x" (x=1~6)

This parameter is for setting the function of button. Options:

- | | |
|----------------------|---------------------------|
| Disable | Shift register |
| Switch | Multiple operation |
| Dimming | Delay mode |
| Value sender | RTC operation mode |
| Scene control | String(14bytes) |
| Blind | |

Chapters as follow explain the button function separately.

Note: When the panel is configured as “Push button sensor”, some of the functions can also set dynamic effects, and the parameters of the function icons are set the same, this chapter will not repeat.

5.8.1.1.Switch function

Fig.5.8.1.1 Parameter setting of switch function

Parameter "Description (max 30char.)"

This parameter is for setting the name description for the current button function, up to input 30 characters.

Parameter "Distinction between short and long operation"

This parameter is for setting whether to distinction the contact operation between short and long operation. Options:

No

Yes

When select "Yes", the operation reaches a certain time to determine whether the operation is a long or short operation before the contact performs the setting action.

Parameter "Reaction on short/press operation"

Parameter "Reaction on long/release operation"

These parameters are for setting the performed actions when press/release the contact or long/short operation. The object value is updated when the input is determined. Options:

No reaction

OFF

ON

TOGGLE

No action: No telegrams have been sent.

ON: Send the on telegram.

OFF: Send the off telegram.

TOGGLE: Each operation will switch between on and off. For example, if the last telegram was sent

(or received) for on, then the next operation will trigger a telegram for off. When the switch is operated again, it will send a telegram for on etc., So the switch will always remember the previous state and covert to opposite value during next operation.

Parameter "Number of objects"

This parameter is visible when the parameter "Reaction on long/release operation" is not selected "No reaction". Set the number of objects when short/long or press/release operation:

1

2

Parameter "Disable function"

This parameter is for setting trigger value to disable/enable contacts. Options:

Disable

Disable=1/Enable=0

Disable=0/Enable=1

— Parameter "Status LED indication when button disable"

This parameter is visible when previous parameter is selected "Disable=1/Enable=0" or "Disable=0/Enable=1". Set the LED indication status when button disable. Options:

No

Flashing

No: no indication and stay the normal indication status;

Flashing: always flashing until receive the "Enable" telegram it will back to normal indication, the flashing period is 1s on and 1s off.

— Parameter "LED indication colour"

This parameter is visible when previous parameter is selected "Flashing". Set the LED indication colour, and when it is a customized colour, you need to configure the the colour in the "Customized colour" interface.Options:

Red

Green

Blue

White

Yellow

Orange

Cyan blue

Customized colour 1

Customized colour 2

Customized colour 3

Cyan

Customized colour 4

Magenta

Customized colour 5

Repeat parameters will not be illustrated in next chapters; the usage is similar.

5.8.1.2. Dimming function

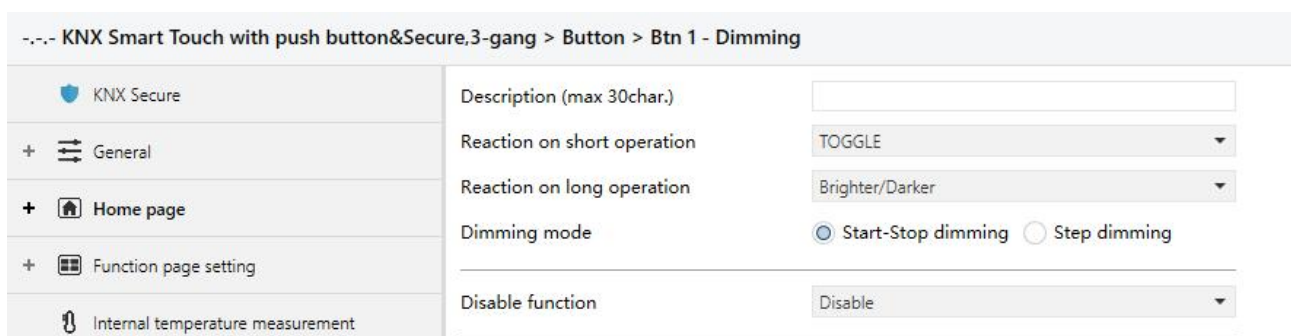

Fig.5.8.1.2 Parameter setting of dimming function

Parameter "Reaction on short operation"

This parameter is for setting the the switch value to send when short operation. Options:

No reaction

OFF

ON

TOGGLE

No action: No telegrams have been sent.

ON: Send the on telegram.

OFF: Send the off telegram.

TOGGLE: Each operation will switch between on and off.

Parameter "Reaction on long operation"

This parameter is for setting the the relative dimming value to send when long operation, with dimming brightness or darker; when release the contact stop dimming. Options:

No reaction

Brighter

Darker

Brighter/Darker

No action: No telegrams have been sent.

Brighter: The dimming up value will be sent.

Darker: The dimming down value will be sent.

Brighter/Darker: Dimming up and down will be sent alternately.

Note: In "TOGGLE" mode of this parameter setting, the value sent will be linked. For example, if the last value is switching on status, then it will be dimmed down in next dimming operation; if the last value is switching off, then it will be dimmed up in next dimming operation.

Parameter "Dimming mode"

This parameter is visible when previous parameter is not "No reaction". Set the way of relative dimming. Options:

Start-Stop dimming

Step dimming

Start-stop dimming: The dimming mode will be start-stop, a dimming up or down telegram will be sent when the dimming starts, and a stop telegram will be sent when dimming ends. Here the dimming telegram will not be sent cyclically.

Steps dimming: The dimming mode will be a step one and the dimming telegram will be sent cyclically. When dimming ends, a stop dimming telegram will be sent immediately.

—Parameter " Step size"

This parameter is visible when the dimming way is selected "Step dimming". Set a cyclically sending dimming telegram which changes the brightness percentage, Options:

100%

50%

...

1.56%

—Parameter “Interval of tele. cyclic send [0..25,0=send once]*0.1s”

This parameter is visible when the dimming way is selected “Step dimming”. Set intervals of two cyclically sending dimming telegram. Options: **0..25, 0=send once**

5.8.1.3.Value sender function

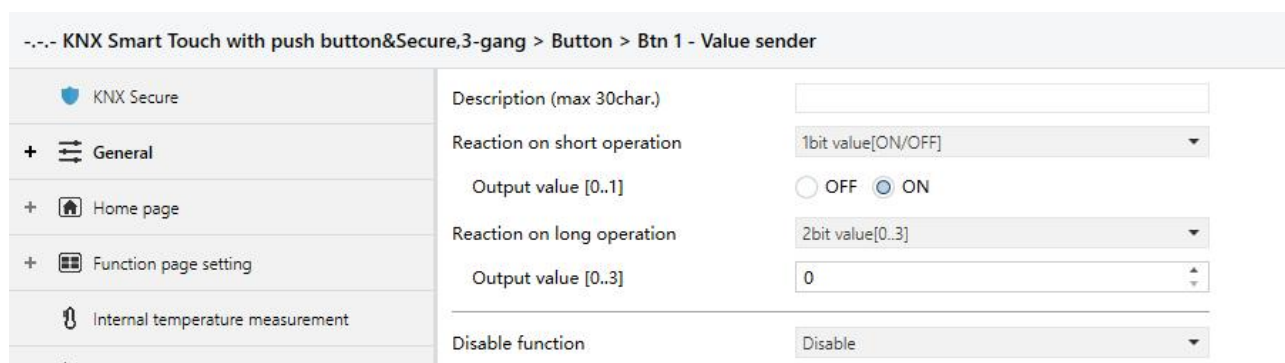

Fig.5.8.1.3 Parameter setting of value sender

Parameter “Reaction on short operation”

Parameter “Reaction on long operation”

These parameters are for setting the datatype to send when long/short operation. Options:

No reaction

1bit value[ON/OFF]

2bit value[0..3]

4bit value[0..15]

1byte value[0..255]

2byte value[0..65535]

—Parameter “Output value ...”

This parameter is visible when “No reaction” is not selected. Set the data value to send when perform short/long operation. Range of value is determined according to the previous parameter selected datatype.

5.8.1.4. Scene function

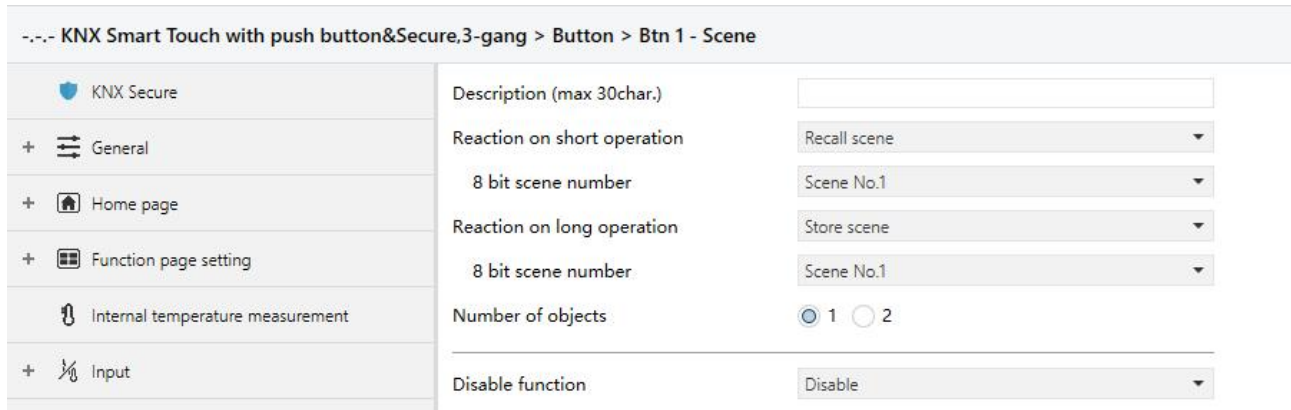

Fig.5.8.1.4 Parameter setting of scene function

Parameter "Reaction on short operation"

Parameter "Reaction on long operation"

These parameters are for setting to recall or storage scene when long/short operation. Options:

No reaction

Recall scene

Store scene

Parameter "8 bit scene number"

This parameter is visible when "No reaction" is not selected. Set the scene number. Options:

Scene NO.1

Scene NO.2

Scene NO.3

...

Scene NO.64

Corresponding telegram is 0~63

Parameter "Number of objects"

This parameter is visible when the parameter "Reaction on long operation" is not selected "No reaction". Set the number of objects when short/long operation:

1

2

5.8.1.5.Blind function

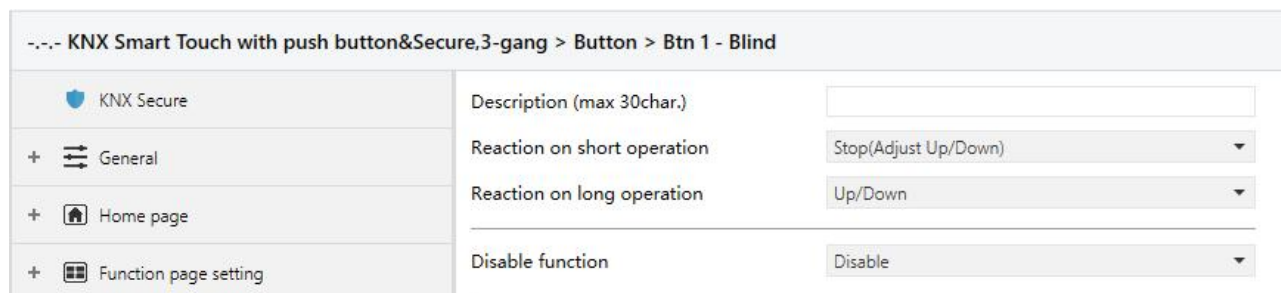

Fig.5.8.1.5 Parameter setting of blind function

Parameter "Reaction on short operation"

Parameter "Reaction on long operation"

These parameters are for setting to performed actions when long/short operation. Options:

No reaction

Up

Down

Up/Down

Stop(Adjust Up)

Stop(Adjust Down)

Stop(Adjust Up/Down)

No action: No action is performed.

Up: The curtains/blinds will be opened or moved up.

Down: The curtains/blinds will be closed or moved down.

Up/Down: Alternately open/close or move up/down the curtains/blinds.

Stop (Adjust Up): Stop the curtain movement or move up the angle of blinds.

Stop (Adjust Down): Stop the curtain movement or move down the angle of blinds.

Stop (Adjust Up/Down): Stop the curtain movement or move up/down the angle of blinds alternately.

Parameter "Interval of tele. cyclic send [0..25,0=send once]*0.1s"

This parameter is visible when previous parameter is selected "Stop...". Set the time interval of cyclical blinds angle adjustment telegram sent. Options: **0..25,0=send once**

5.8.1.6.Shift register function

--- KNX Smart Touch with push button&Secure,3-gang > Button > Btn 1 - Shift register

<ul style="list-style-type: none"> KNX Secure General Home page Function page setting Internal temperature measurement Input HVAC controller Button 	Description (max 30char.) <input type="text"/> Shift type <input checked="" type="radio"/> Shift by step value <input type="radio"/> Shift without step value Value begin with <input type="text" value="0"/> Value end with(must be larger than value begin with) <input type="text" value="10"/> Step size <input type="text" value="2"/> Direction <input type="text" value="From lowest to highest and cyclically"/> Reset function <input checked="" type="radio"/> Disable <input type="radio"/> Enable by long operation Disable function <input type="text" value="Disable"/>
---	--

Fig.5.8.1.6(1) Parameter setting of shift register function

--- KNX Smart Touch with push button&Secure,3-gang > Button > Btn 1 - Shift register

<ul style="list-style-type: none"> KNX Secure General Home page Function page setting Internal temperature measurement Input HVAC controller Button Btn 1 - Shift register Customized colour 	Description (max 30char.) <input type="text"/> Shift type <input type="radio"/> Shift by step value <input checked="" type="radio"/> Shift without step value Object datatype <input type="text" value="1byte unsigned value"/> Shift number <input type="text" value="4"/> Value 1 <input type="text" value="0"/> Value 2 <input type="text" value="1"/> Value 3 <input type="text" value="2"/> Value 4 <input type="text" value="3"/> Direction <input type="text" value="From lowest to highest and cyclically"/> Reset function <input checked="" type="radio"/> Disable <input type="radio"/> Enable by long operation Disable function <input type="text" value="Disable"/>
--	---

Fig.5.8.1.6(2) Parameter setting of shift register function

Parameter "Shift type"

This parameter is for setting the shift type. Options:

Shift by step value

Shift without step value

Shift by step value: Here the starting value and stopping value of shift can be set, the value increased (from low to high) or decreased (from high to low) from every shift can also be set.

Shift without step value: When there's no step value, the actual value sent by each shift can be set (max. 10 value), in every operation one value will be sent.

Three parameters as follow are visible when “Shift by step value” is selected

—Parameter “Value begin with”

This parameter is for setting the starting value of the shift. Options: **0..240**

—Parameter “Value end with(must be larger than value begin with)”

This parameter is for setting the stopping value of the shift. Options: **1..250**

The stopping value must be larger than begin value.

—Parameter “Step size”

This parameter is for setting the increase (from low to high) or decrease (from high to low) value.

Options: **0..240**

Parameters as follow are visible when “Shift without step value” is selected

Parameter “Object datatype”

This parameter is for setting the object datatype for the shift object. Option: **1byte unsigned value/Scene number/HVAC mode**

—Parameter “Shift number”

This parameter is for setting the number of shift, up to set maximum 10 values, Options: **0/1/2../10**

—Parameter “Value x”(x=1~10)

This parameter is for setting the value when each shift operation to send.,the value sent depends on the data type.

Options: **0..255/Scene N01~64/Comfort mode/standby mode/Economy mode/Frost/heat**

protection

Parameter “Direction”

This parameter is for setting the shift direction. Options:

From lowest to highest and stop to the end

From highest to lowest and stop to the begin

From lowest to highest and cyclically

From highest to lowest and cyclically

From lowest to highest and stop to the end: Shift from low to high.

From highest to lowest and stop to the begin: Shift from high to low.

From lowest to highest and cyclically: once to the end value, shift direction starts over again and constantly cycling from low to high operation.

From highest to lowest and cyclically: once to the start value, shift direction starts over again and constantly cycling from high to low operation.

Parameter "Reset function"

This parameter is for setting whether to enable shift reset function. Options:

Disable

Enable by long operation

Disable: Not possible to reset shift;

Enable by long operation: Possible to reset shift by long operation, when reset, shift will start new.

5.8.1.7. Multiple operation function

--- KNX Smart Touch with push button&Secure,3-gang > Button > Btn 1 - Multiple operation

<ul style="list-style-type: none"> KNX Secure + General + Home page + Function page setting Internal temperature measurement + Input + HVAC controller - Button <li style="background-color: #e0e0e0;">Btn 1 - Multiple operation Customized colour + Logic function + Scene group function 	<p>Description (max 30char.) <input type="text"/></p> <p>Object type for object1 1Bit_On/Off ▼</p> <p>Function of short operation TOGGLE ▼</p> <p>Function of long operation No reaction ▼</p> <hr/> <p>Object type for object2 1Bit_On/Off ▼</p> <p>Function of short operation TOGGLE ▼</p> <p>Function of long operation No reaction ▼</p> <hr/> <p>Object type for object3 1Bit_On/Off ▼</p> <p>Function of short operation TOGGLE ▼</p> <p>Function of long operation No reaction ▼</p> <hr/> <p>Object type for object4 1Bit_On/Off ▼</p> <p>Function of short operation TOGGLE ▼</p> <p>Function of long operation No reaction ▼</p> <hr/> <p>Disable function Disable ▼</p>
---	---

Fig.5.8.1.7 Parameter setting of multiple operation function

Parameter "Object type for object x"(x=1~4)

This parameter is for setting the datatype when long/short operation to send. Options:

Disable

1Bit_On/Off

1Bit_Up/Down

1Byte_RecallScene

1Byte_StoreScene

1Byte_Percentage

1Byte_Unsigned value

— Parameter "Function of short operation"

— Parameter "Function of long operation"

This parameter is for setting the specific values to send when perform the operation, either no action or sending value (the specific value will be set in next parameter).

— Parameter "Value x..."(x=1~2)

This parameter is visible when object type is selected "1byte_RecallScene", "1byte_StoreScene", "1byte_Percentage", "1byte_Unsigned value". Set sending values when perform operations. The range of value is up to the datatype selected by the parameter before last one.

5.8.1.8.Delay mode function

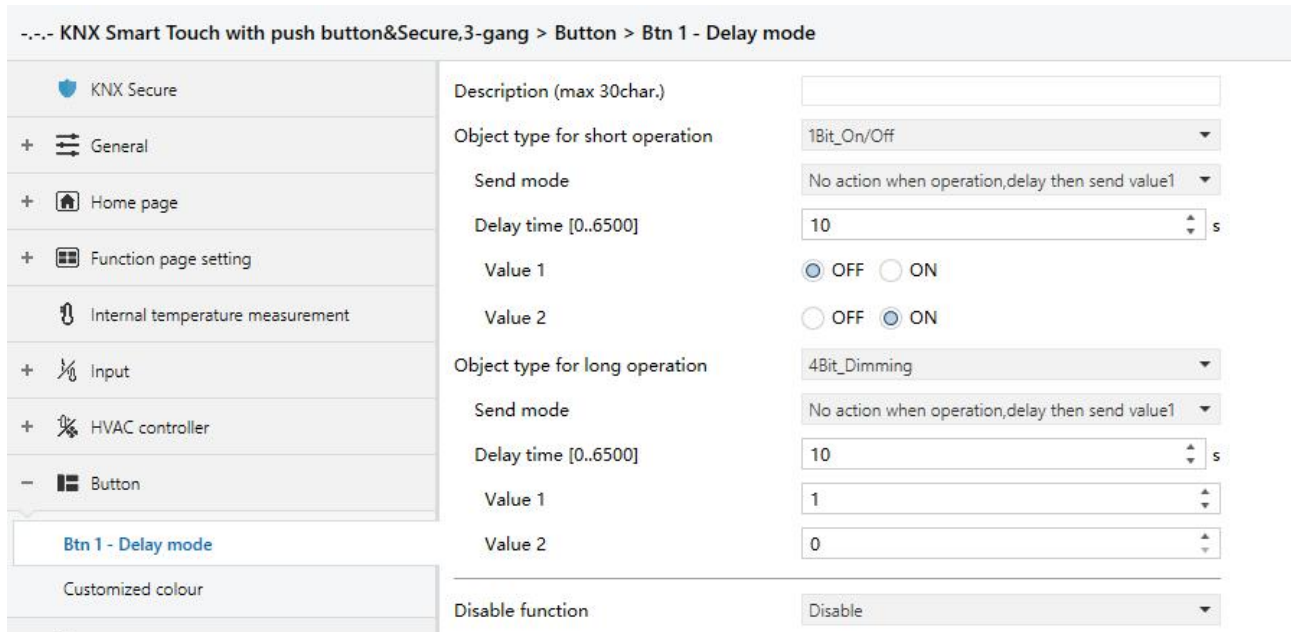

Fig.5.8.1.8 Parameter setting of delay mode function

Parameter "Object type for short operation"

Parameter "Object type for long operation"

These parameters are for setting the datatype when long/short operation to send. Options:

- Disable**
- 1Bit_On/Off**
- 4Bit_Dimming**
- 1Byte_Unsigned value**

Parameter "Send mode"

This parameter is for setting the send mode. Options:

- No action when operation, delay then send value1**
- No action when operation, delay then send value2**
- Send value1 when operation, delay then send value2**
- Send value2 when operation, delay then send value1**

Parameter "Delay time [0..6500]s"

This parameter is for setting the delay time. Options: **0..6500**

Parameter "Value x" (x=1~2)

This parameter is for setting the value 1/2 to send. The range of value is up to the datatype selected by the parameters.

5.8.1.9.RTC mode function

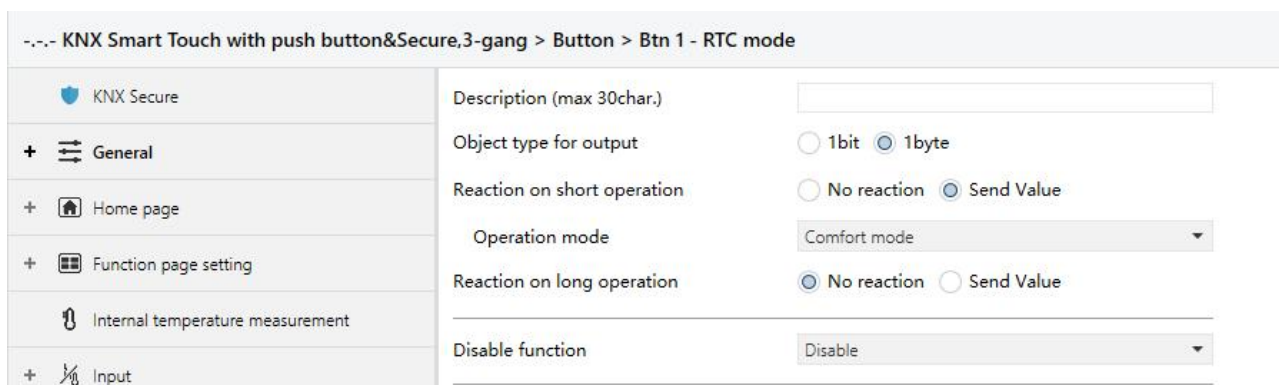

Fig.5.8.1.9 Parameter setting of RTC mode function

Parameter "Object type for output"

This parameter is for setting object datatype for output. Options:

1bit

1byte

Parameter "Reaction on short operation"

Parameter "Reaction on long operation"

These parameters are for setting the performed operation when long/short operation. Options:

No reaction

Send Value

Parameter "Operation mode"

This parameter is visible when "No reaction" is not selected. Set the operation mode of RTC.

Options:

Auto

Comfort mode

Standby mode

Economy mode

Frost/heat protection

Activate corresponding modes when object telegram is 1, and not activated when object telegram is 0. All is standby mode when all objects telegram are 0.

Note: There is no "Auto" selected when output object is 1 bit.

Parameter "Standby mode object"

Consider that some products will not have this object, so that set the object, send telegram 1 when standby mode.

This parameter is visible when 1bit is selected. Set whether to enable the object of standby mode.

Options:

Disable

Enable

5.8.1.10. Sting function

--- KNX Smart Touch with push button&Secure,3-gang > Button > Btn 1 - String

<ul style="list-style-type: none"> KNX Secure + General + Home page + Function page setting Internal temperature measurement + Input + HVAC controller - Button <ul style="list-style-type: none"> Btn 1 - String Customized colour 	<p>Description (max 30char.) <input type="text"/></p> <p>Reaction on short operation <input type="radio"/> No reaction <input checked="" type="radio"/> Send Value</p> <p>String (14byte) value <input type="text" value="Hello, world !"/></p> <p>Reaction on long operation <input type="radio"/> No reaction <input checked="" type="radio"/> Send Value</p> <p>String (14byte) value <input type="text" value="Hello, world !"/></p> <hr/> <p>Disable function <input type="text" value="Disable"/></p> <hr/> <p>Status LED indication <input type="text" value="Indicate button press"/></p> <p>When press the button,indicator is <input type="radio"/> On <input checked="" type="radio"/> Flashing</p> <p>Flashing period time is <input type="text" value="0.8"/> s</p> <p>Normal indication is <input checked="" type="radio"/> OFF <input type="radio"/> ON</p> <p>LED indication colour <input type="text" value="Red"/></p>
---	--

Fig.5.8.1.10 Parameter setting of sting function

Parameter "Reaction on short operation"

Parameter "Reaction on long operation"

These parameters are for setting the performed operation when long/short operation. Options:

No reaction

Send Value

Parameter "String (14byte) value"

This parameter is visible when "Send Value" is selected. Set the sting value to send.

5.8.1.11.LED indication function

Status LED indication	Control by button switch object
When object value="0", LED is	OFF
When object value="1", LED is	Blue
Control by button switch object	
Status LED indication	Control by external object
External object datatype	<input checked="" type="radio"/> 1bit <input type="radio"/> 1byte
When object value="0", LED is	OFF
When object value="1", LED is	Blue
Control by external object	
Status LED indication	Control by external object
External object datatype	<input type="radio"/> 1bit <input checked="" type="radio"/> 1byte
Threshold value is	50
If object value<threshold value, LED is	OFF
If object value=threshold value, LED is	Red
If object value>threshold value, LED is	OFF
Control by external object	
Status LED indication	Indicate button press
When press the button,indicator is	<input checked="" type="radio"/> On <input type="radio"/> Flashing
On duration time is	1s
LED indication colour	Red
Indicate button press	
Status LED indication	Indicate button press
When press the button,indicator is	<input type="radio"/> On <input checked="" type="radio"/> Flashing
Flashing period time is	0.8 s
Normal indication is	<input checked="" type="radio"/> OFF <input type="radio"/> ON
LED indication colour	Red
Indicate button press	
Status LED indication	Always on
LED indication colour	Red
Always on	

Fig.5.8.1.11 Parameter setting of LED indication function

Parameter "Status LED indication"

This parameter is for setting the LED indication status. When button function set with switch function, such as switch, dimming function. Options:

Disable

Control by button switch object

Control by external object

Indicate button press

Always on

There is no option "Control by button switch object" when not with switch function, such as scene, blind, value sender, delay mode and etc.

Parameters as follow are visible when LED indication status is selected "Control by button switch object".

——Parameter "When object value="0", LED is"

——Parameter "When object value="1", LED is"

These parameters are for setting the LED indication colour according to switch function and dimming function. Options:

OFF	Orange
Red	Cyan blue
Green	Customized colour 1
Blue	Customized colour 2
White	Customized colour 3
Yellow	Customized colour 4
Cyan	Customized colour 5
Magenta	

Parameters as follow are visible when LED indication status is selected "Control by external object".

——Parameter "External object datatype"

This parameter is for setting the external object datatype. Options:

1bit

1byte

Note: The object will send read request when the device power on, indicate according to the response value, and no handled when no receive a response.

Two parameters as follow are visible when 1 bit is selected.

—Parameter “When object value=“0”, LED is”

—Parameter “When object value=“1”, LED is”

These parameters are for setting the LED indication colour according to 1 bit object value from the bus. Options:

OFF	Orange
Red	Cyan blue
Green	Customized colour 1
Blue	Customized colour 2
White	Customized colour 3
Yellow	Customized colour 4
Cyan	Customized colour 5
Magenta	

Four parameters as follow are visible when 1 byte is selected.

—Parameter “Threshold value is”

This parameter is for setting the threshold value. Options: **1..255**

—Parameter “If object value<threshold value, LED is”

—Parameter “ If object value=threshold value, LED is”

—Parameter “ If object value>threshold value, LED is”

These parameters are for setting the LED indication colour according to the comparison of both the object value and the threshold value. Options:

OFF	Orange
Red	Cyan blue
Green	Customized colour 1
Blue	Customized colour 2
White	Customized colour 3
Yellow	Customized colour 4
Cyan	Customized colour 5

Magenta

Parameters as follow are visible when LED indication status is selected "Indicate button press".

—Parameter "When press the button,indicator is"

This parameter is for setting the LED indication status when press the button. Options:

On

Flashing

Parameter as follow is visible when On is selected.

—Parameter "On duration time is"

This parameter is for setting the LED on duration time. Options: **500ms/1s/2s/3s**

Parameters as follow are visible when Flashing is selected.

—Parameter "Flashing period time is"

This parameter is for setting the LED flashing period time> options:

0.4s

0.8s

...

2.0s

—Parameter "Normal indication is"

This parameter is for setting the LED normal indication when finish flashing. Options:

OFF

ON

Parameter as follow is visible when LED indication status is selected "Indicate button press" or "Always on".

—Parameter "LED indication colour"

This parameter is for setting the LED indication colour. Options:

Red

Orange

Green

Cyan blue

Blue

Customized colour 1

White

Customized colour 2

- Yellow **Customized colour 3**
- Cyan **Customized colour 4**
- Magenta **Customized colour 5**

5.8.2. Customized linking setting

--- KNX Smart Touch with push button&Secure,3-gang > Button

- + KNX Secure
- + ☰ General
- + 🏠 Home page
- + ⚙️ Function page setting
- + 🌡️ Internal temperature measurement
- + 🔌 Input
- + 🌬️ HVAC controller
- 🔘 **Button**
- Customized colour
- + 🔗 Logic function
- + 👥 Scene group function

Panel function as

Push button sensor

Customized linking to touch

Panel preview



Long operation for button after [3...250] *0.1s

Overwrite customized linking setting during download

Button 1 & 2 use as Independent button Link button

Button 3 & 4 use as Independent button Link button

Button 5 & 6 use as Independent button Link button

i Note: If the icon function of touch to link is Relative/Brightness dimming or ..curtain/blind.., it must be used as link button. Otherwise, the setting of the other button in one pair (button 2 or 4 or 6) will be ignored even no matter what it set.

Associated function for button 1 None Link to icon in page 1

Associated function for button 2 None Link to icon in page 1

Associated function for button 3 None Link to icon in page 1

Associated function for button 4 None Link to icon in page 1

Associated function for button 5 None Link to icon in page 1

Associated function for button 6 None Link to icon in page 1

Fig.5.8.2 Parameter setting of customized linking to touch

Parameter "Overwrite customized linking setting during download"

This parameter is for setting whether to overwrite the shortcut button link after ETS download. If it is, the button function will be determined by the database parameter; if not, the button function will be reserved if it is linked. And if the button function is not linked, it will be determined by the database parameter.

Parameter "Button 1& 2 use as"

Parameter "Button 3& 4 use as"

Parameter "Button 5& 6 use as"

These parameter are for setting the button operation way. Options:

Independent button

Link button

Two neighboring buttons are used independently of each other when select "Independent button", for example button 1, 2; two neighboring buttons are used in linking, or example button 1&2.

Note: For relative dimming and brightness dimming function, and curtain function, when it is configured as "Independent button", re-downloading will lose the link.

i Note: If the icon function of touch to link is "Relative/Brightness dimming" or "...curtain/blind..", it must be used as link button. Otherwise, the setting of the other button in one pair (button 2 or 4 or 6) will be ignored even no matter what it set.

Parameter "Associated function for button 1/.../6"

These parameters are visible when "Independent button" is selected. Set the the function page associated with each independent button. The number of function pages according to the selection.

Options:

None

Link to icon in page 1

Link to icon in page 2

...

Link to icon in page 6

Parameter "Associated function for button 1&2/3&4/5&6"

These parameters are visible when "Link button" is selected. Set the the function page associated with each link button. The number of function pages according to the selection. Options:

None

Link to icon in page 1

Link to icon in page 2

...

Link to icon in page 6

Note: You can preset the function link to each button on the ETS when the panel used as customized linking, and also can link to icons of function page. If the selected function is not meet the logical definition of the link, it is invalid setting. Modify these linking via screen.

—Parameter "Icon number"

This parameter is for setting the icon number associated with button. The number of icons according to the function page display 4 or 6, options:

1

2

...

6

5.8.3.Parameter window “Customized colour”

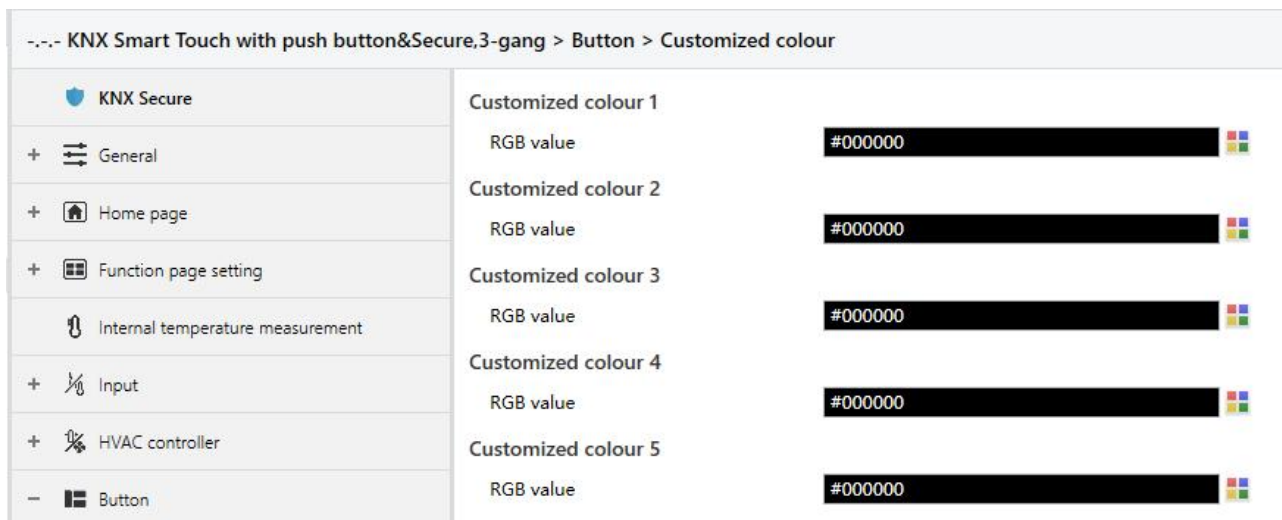

Fig.5.8.3 “Customized colour” parameter window

Customized colour x (x=1~5)

Parameter “RGB value”

This parameter is for setting the customized colour of LED indication, user up to define 5 colours.

Options: #000000#FFFFFF

5.9.Parameter window “Logic”

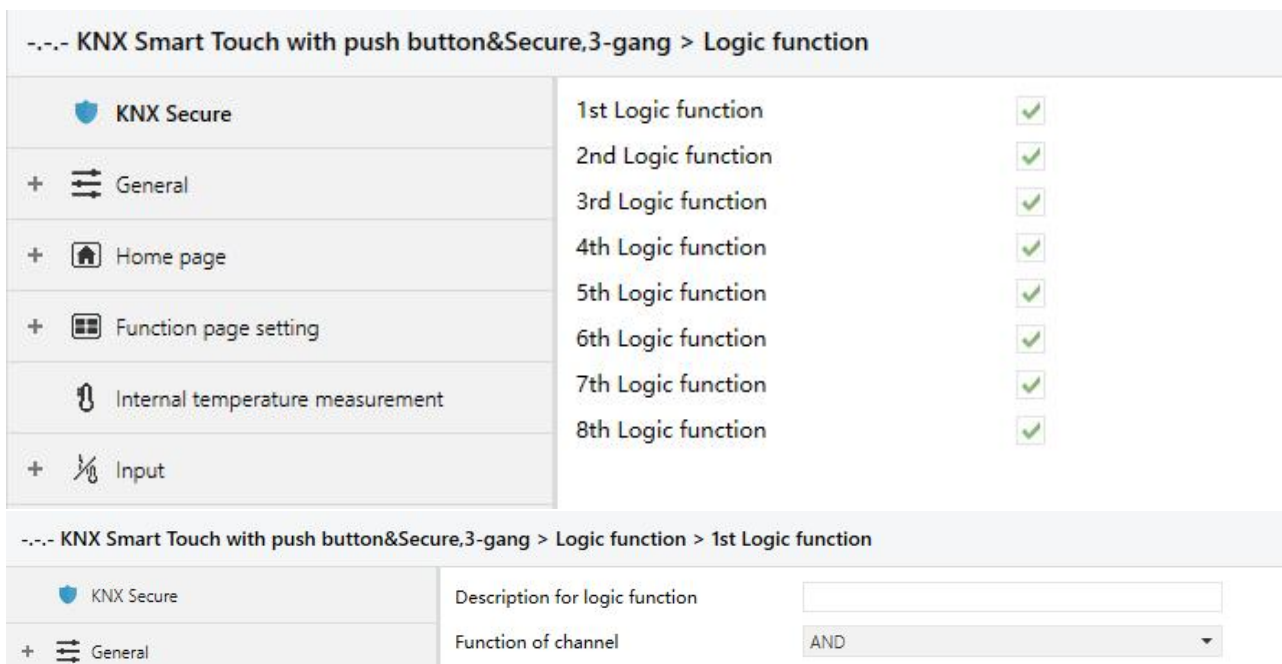

Fig.5.9 “Logic function setting” parameter window

Parameter "1st/2nd/3rd... Logic function"

This parameter is for setting the setting interface of logic function, display corresponding logic function page when select. Up to enable 8 logic functions.

Parameter "Description for logic function"

This parameter is for setting the name description for logic function, up to input 30 characters.

Parameter "Function of channel"

This parameter is for setting function of the channel. Options:

AND

OR

XOR

Gate forwarding

Threshold comparator

Format convert

Gate function

Delay function

Staircase lighting

AND/OR/XOR: as the parameter is similar to the communication object (only the logic algorithm is different), the following parameters taking one options for example.

5.9.1.Parameter window “AND/OR/XOR”

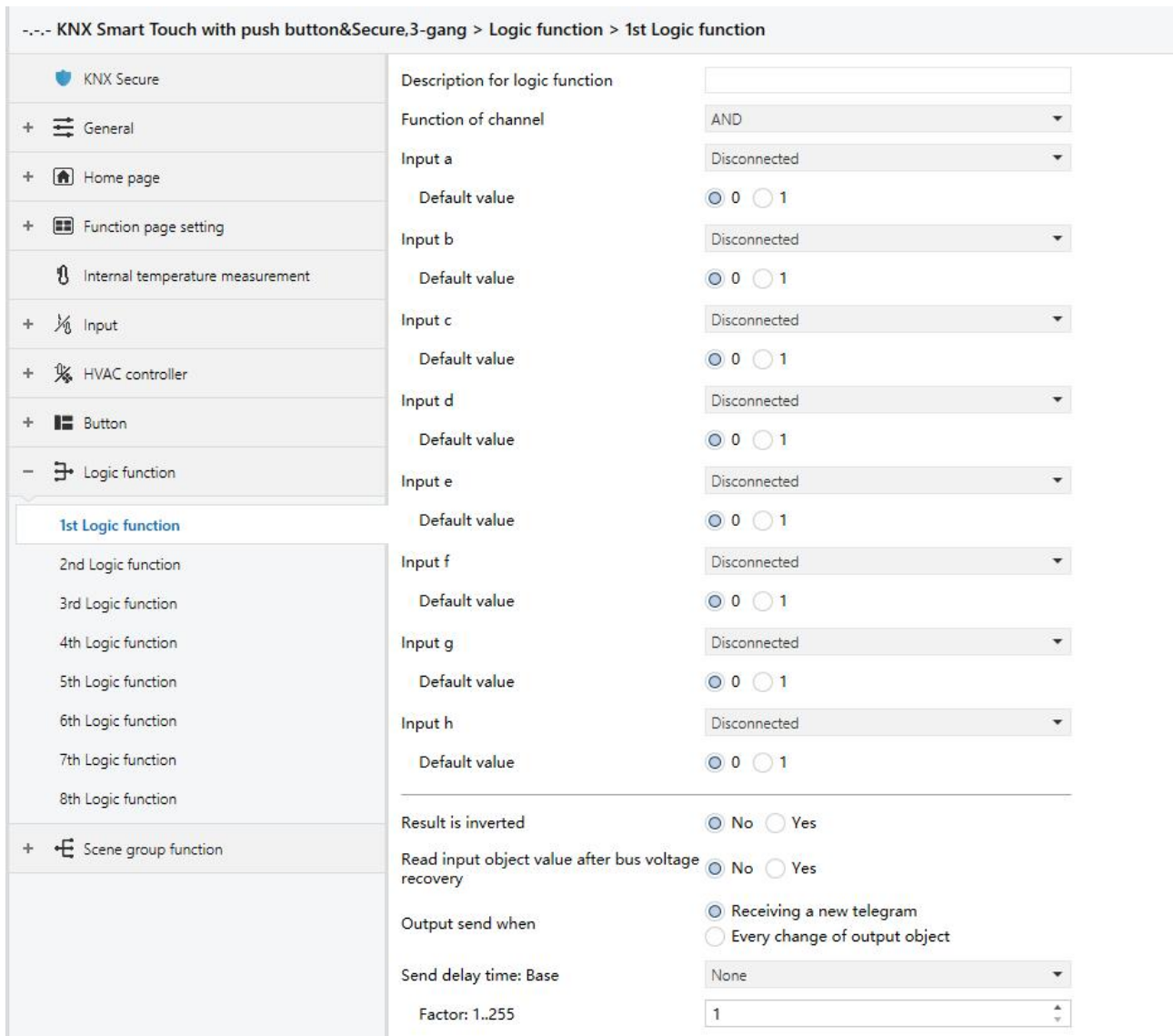

Fig.5.9.1 “AND/OR/XOR” parameter window

Parameter “Input a/b/c/d/e/f/g/h”

This parameter is for setting whether input x to calculate, whether to normally calculate or inverted calculate. Options:

Disconnected

Normal

Inverted

Disconnected: not to calculate;

Normal: to directly calculate the input value;

Inverted: invert the input value, then to calculate. **Note: not to invert the initiate value.**

Parameter "Default value"

This parameter is for setting the initial value of logic input x. Options:

0

1

Parameter "Result is inverted"

This parameter is for setting whether to invert the logic calculation result. Options:

No

Yes

No: output directly;

Yes: output after inverting.

Parameter "Read input object value after voltage recovery"

This parameter is for setting whether to send the read request to the logic input object after device voltage recovery or finish programming. Options:

No

Yes

Parameter "Output send when"

This parameter is for setting the condition of sending logic result. Options:

Receiving a new telegram

Every change of output object

Receiving a new telegram: every time the object received a new input value will the logic result be sent to the bus;

Every change of output object: only when logic result has changed will it be sent to the bus.

Tip: when in the first time to logic calculate, the logic result will be sent even if it has no change.

Parameter "Send delay time"

Base: None

0.1s

1s

...

10s

25s

Factor: 1..255

This parameter is for setting the delay time for sending the logic calculation result to the bus. Delay time = Base × Factor, if option “None” of Base is selected, then there is no delay.

5.9.2.Parameter window “Gate forwarding”

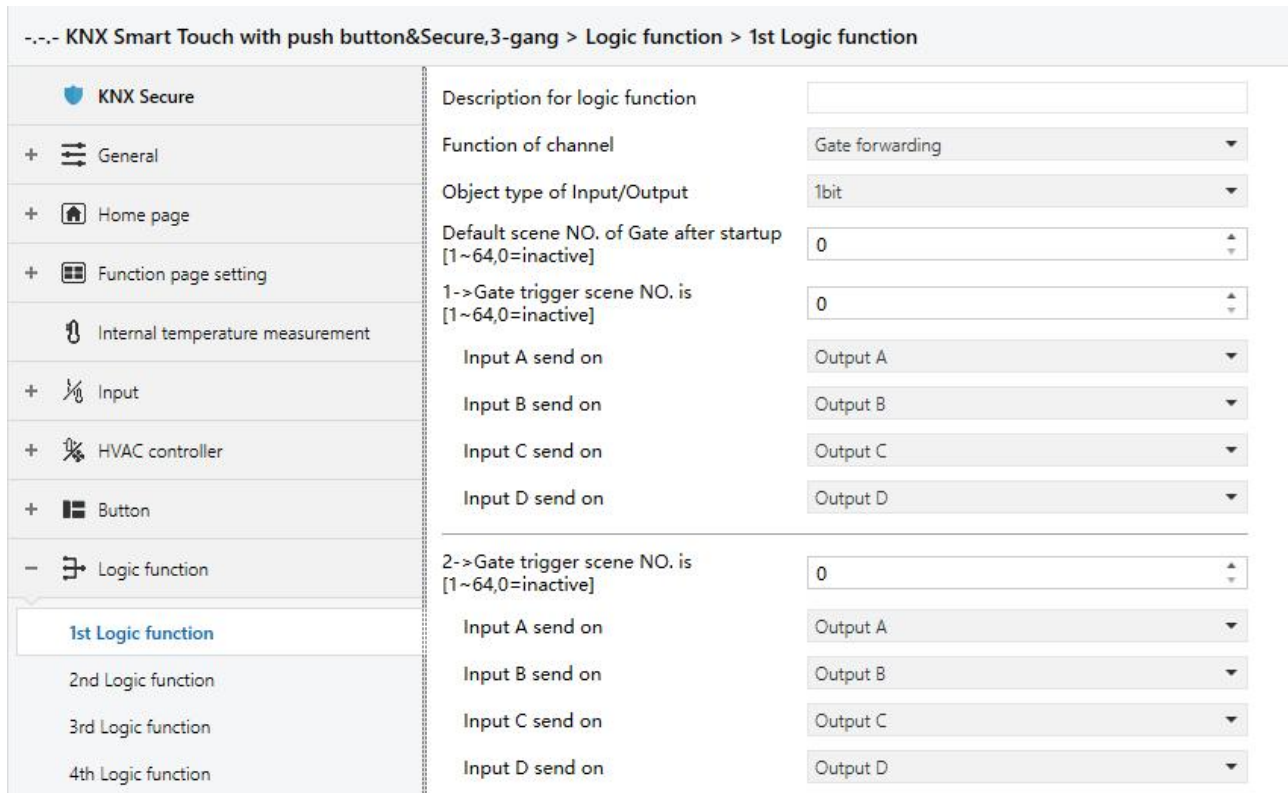

Fig.5.9.2 “Gate forwarding” parameter window

Parameter “Object type of Input/Output”

This parameter is for setting the object type of input/output. Options:

1bit

4bit

1byte

Parameter "Default scene NO. of Gate after startup [1~64,0=inactive]"

This parameter is for setting the initial scene where logical gate forwarding can be performed by default after device starts, which needs to be configured in the parameters. Options: **1..64, 0=inactive**

Note: gate scene is recommended to be selected before operating, or it will enable the initiate scene by default.

Parameter "z->Gate trigger scene NO. is [1~64,0=inactive]" (z=1~8)

This parameter is for setting scene number of logic gate forwarding. Up to 8 trigger scene number can be set for each logic. Options: **1..64, 0=inactive**

——Parameter "Input A/B/C/D send on"

This parameter is for setting the output of input X (X=A/B/C/D) after gate forwarding. Options:

Output A

Output B

...

Output B,C,D

According to the options, one input can be forwarded into one or more outputs, the output value is the same as the input value.

5.9.3.Parameter window “Threshold comparator”

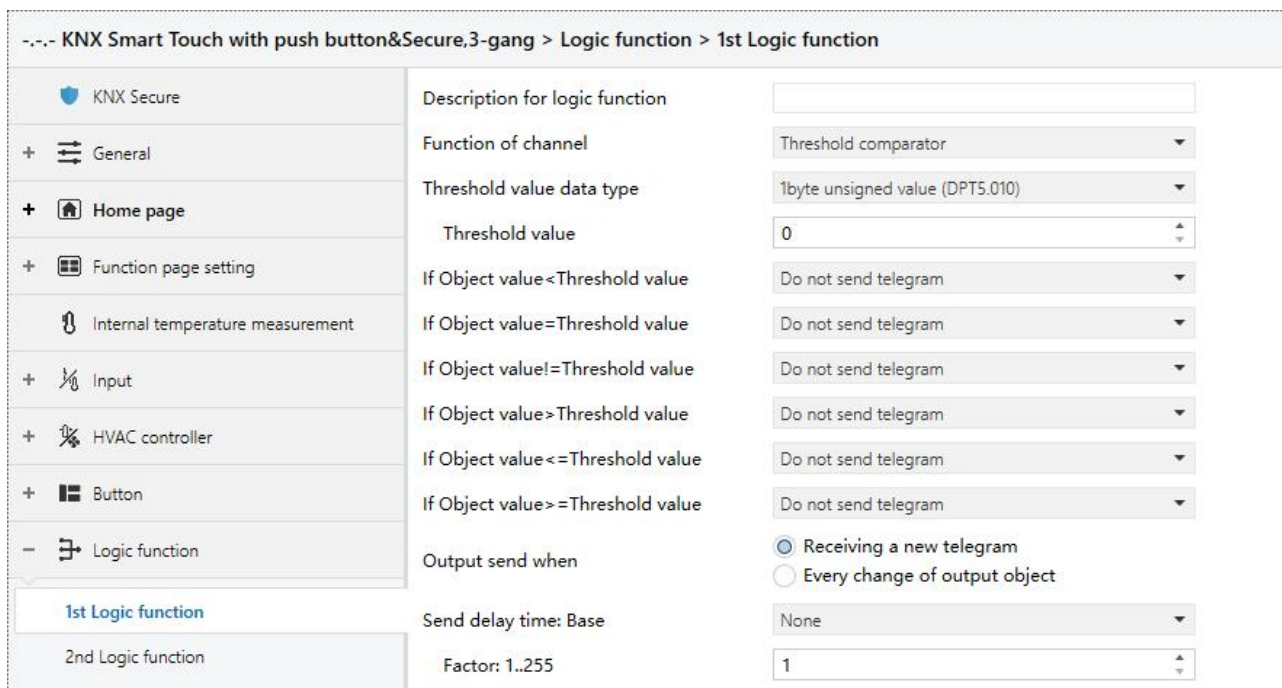

Fig.5.9.3 “Threshold comparator” parameter window

Parameter “Threshold value data type”

This parameter is for setting the threshold value data type. Options:

- 4bit value (DPT3.007)**
- 1byte unsigned value (DPT5.010)**
- 2byte unsigned value (DPT7.001)**
- 2byte signed value (DPT8.x)**
- 2byte float value (DPT9.x)**
- 4byte unsigned value[0..4294967295]**
- Ext. temperature value (DPT 9.001)**
- Ext. humidity value (DPT 9.007)**
- Illuminance value (DPT 9.004)**

Parameter “Threshold value ”

This parameter is for setting threshold value, the range depends on the data type. Options:

- 4bit value (DPT3.007) 0..15 / 1byte unsigned value (DPT5.010) 0..255 /**
- 2byte unsigned value (DPT7.001) 0..65535 / 2byte signed value (DPT8.x) -32768..32767 /**
- 2byte float value (DPT9.x) -670760...670760 / 4byte unsigned value[0..4294967295]**
- 0..4294967295 /**
- Ext. temperature value (DPT 9.001) -20..95°C / Ext. humidity value (DPT 9.007) 0..100% /**
- Illuminance value (DPT 9.004) 0..65535lux**

Parameter "Hysteresis threshold value"

This parameter is visible when object datatype is selected "2byte float value (DPT9.x)", "Illuminance value (DPT 9.004)". Set the hysteresis threshold value. Options: **0..500**

Parameter "If Object value<Threshold value"

Parameter "If Object value=Threshold value"

Parameter "If Object value!=Threshold value"

Parameter "If Object value>Threshold value"

Parameter "If Object value<=Threshold value"

Parameter "If Object value>=Threshold value"

This parameter is for setting the logic result value that should be sent when threshold value Less than, equal to, not equal to, greater than, less than or equal to the setting valve. When object datatype is selected "2byte float value (DPT9.x)", can only set the object value less than or greater than threshold value. Options:

Do not send telegram

Send value "0"

Send value "1"

Do not send telegram: not consider to select this option;

Send value "0"/"1": when condition is satisfied, send telegram 0 or1.

If there is a conflict between the setting options between parameters, the base on the value that should be sent when reach the final parameter condition. **For example: parameter "If Object value=Threshold value" is set to be "Send value "0" "; parameter "If Object value<=Threshold value" is set to be "Send value "1" "; when object value is equal to the threshold value, then the logic result will send "1".**

Parameter "Output send when"

This parameter is for setting the condition of sending logic result. Options:

Receiving a new telegram

Every change of output object

Receiving a new telegram: every time the object received a new input value will the logic result be sent to the bus;

Every change of output object: only when logic result has changed will it be sent to the bus.

Tip: when in the first time to logic algorithm, the logic result will be sent even if it has no change.

Parameter "Send delay time"

- Base:** **None**
 0.1s
 1s
 ...
 10s
 25s
- Factor:** **1..255**

This parameter is for setting the delay time for sending the logic algorithm result to the bus. Delay time = Base x Factor, if option "None" of Base is selected, then there is no delay.

5.9.4.Parameter window "Format convert"

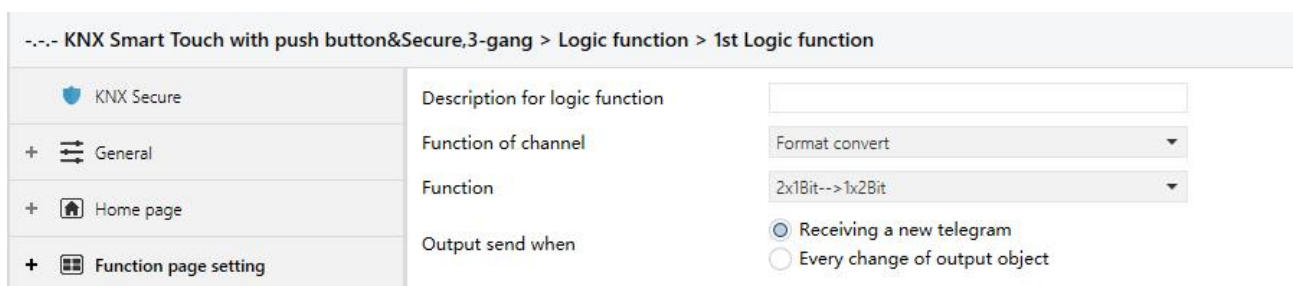

Fig.5.9.4 "Format convert" parameter window

Parameter "Function"

This parameter is for setting the format convert type. Options:

- 2x1bit-->1x2bit**
- 8x1bit-->1x1byte**
- 1x1byte-->1x2byte**

2x1byte-->1x2byte

2x2byte-->1x4byte

1x1byte-->8x1bit

1x2byte-->2x1byte

1x4byte-->2x2byte

1x3byte-->3x1byte

3x1byte-->1x3byte

Parameter "Output send when"

This parameter is for setting the condition of sending logic result. Options:

Receiving a new telegram

Every change of output object

Receiving a new telegram: every time the object received a new input value will the logic result be sent to the bus;

Every change of output object: only when logic result has changed will it be sent to the bus.

Tip: when in the first time to logic algorithm, the logic result will be sent even if it has no change.

5.9.5.Parameter window "Gate function"

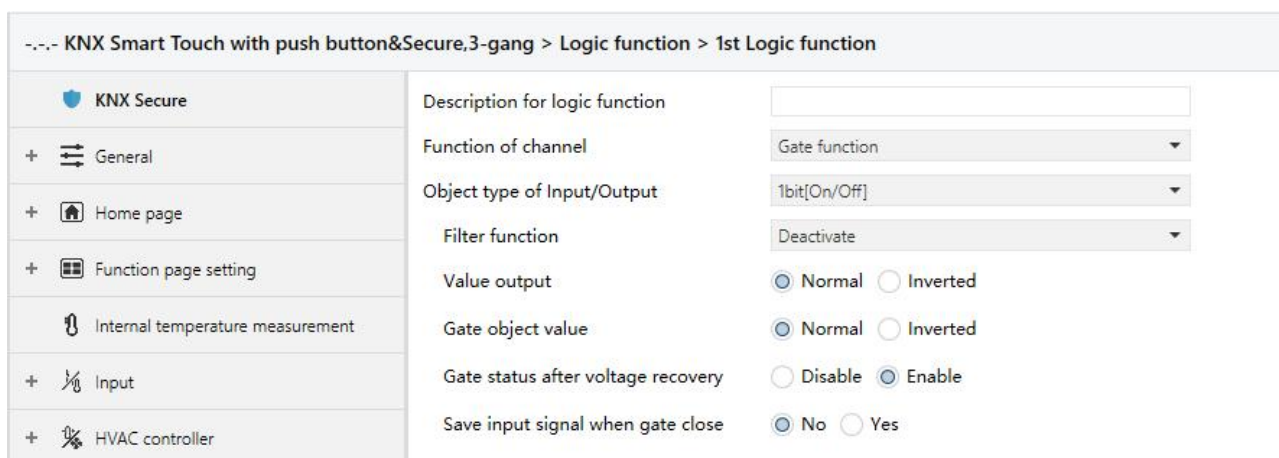

Fig.5.9.5 "Gate function" parameter window

Parameter "Object type of Input/Output"

This parameter is for setting the object type of input/output. Options:

1bit[On/Off]

1byte[0..100%]

1byte[0..255]

2byte[Float]

2byte[0..65535]

Parameter "Filter function"

This parameter is visible when "1bit[On/Off]" is selected. Set whether to filter On or Off telegram, only pass one of them or pass all. Options:

Deactivate

On filter out

Off filter out

Deactivate: Do not filter the On or Off telegrams;

On filter out: Off can pass, On cannot pass;

Off filter out: On can pass, Off cannot pass.

Parameter "Value output"

This parameter is visible when "1bit[On/Off]" is selected. Set whether to invert the value then output it. Options:

Normal

Inverted

Parameter "Gate object value"

This parameter is for setting whether to invert the gate object value then output it. Options:

Normal

Inverted

Parameter "Gate status after voltage recovery"

This parameter is for setting the gate status after power on. Options:

Disable

Enable

Parameter "Save input signal when gate close"

This parameter is for setting whether to save input signal on gate close. Options:

No

Yes

No: disable to save the input, the input values received during the gate closing period are ignored;

Yes: enable to save the input, the input values received during the gate closing period are output when gate is open (whether the input value is changed or not).

5.9.6.Parameter window "Delay function"

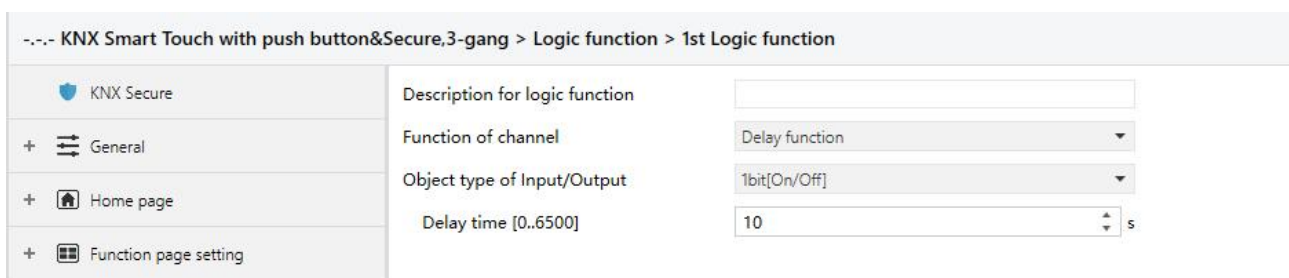

Fig.5.9.6 "Delay function" parameter window

Parameter "Object type of Input/Output"

This parameter is for setting the object type of input/output. Options:

1bit[On/Off]

1byte[0..100%]

1byte[0..255]

2byte[Float]

2byte[0..65535]

Parameter "Delay time [0..6500]s"

This parameter is for setting the delay time that output object forwards the value when the input object receives the telegram. Options: **0..6500**

Note: Receive telegram again in delay time, re-timing.

5.9.7.Parameter window “Staircase lighting”

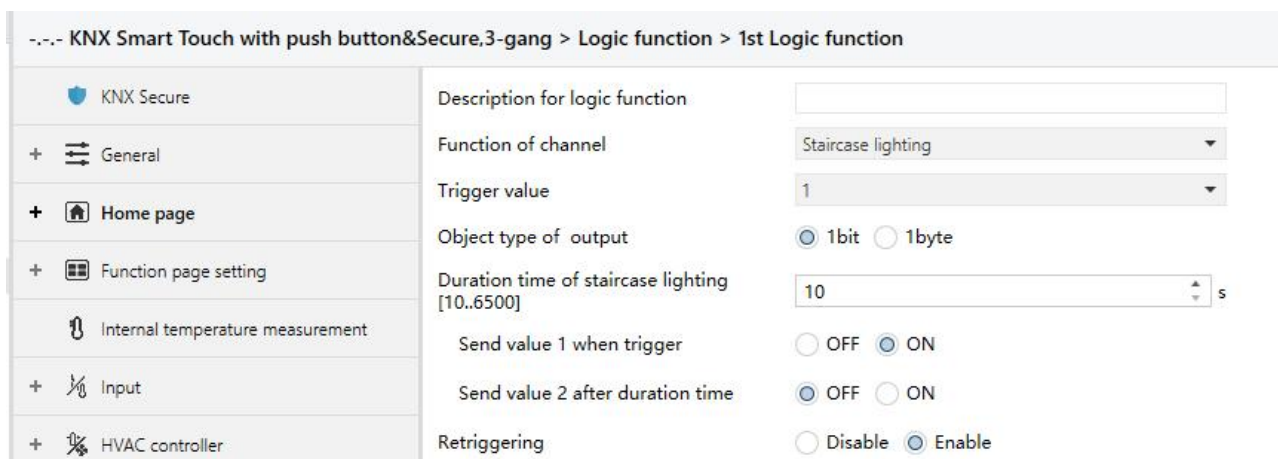

Fig.5.9.7 “Staircase lighting” parameter window

Parameter “Trigger value”

This parameter is for setting the telegram value of the object “Trigger value”. Options:

- 0
- 1
- 0 or 1

Parameter “Object type of output”

This parameter is for setting the object type of output. Options:

- 1bit
- 1byte

Parameter “Duration time of staircase lighting[10..6500]s”

This parameter is for setting duration time of staircase lighting after the stair light power on.

Options: 10..6500

——Parameter “Send value 1 when trigger”

——Parameter “Send value 2 after duration time”

These parameters are for setting the value to send. Send value 1 when trigger, and then send value 2 after duration time. Options display according to the output object datatype.

When 1 bit, options:

- OFF

ON

When 1 byte , options: **0..255**

Parameter "Retriggering"

This parameter is for setting whether to trigger re-timing when received trigger value in delay time.

Options:

Disable

Enable

5.10.Parameter window "Scene Group"

--- KNX Smart Touch with push button&Secure,3-gang > Scene group function > Function setting

<ul style="list-style-type: none"> KNX Secure + General + Home page + Function page setting Internal temperature measurement + Input 	<ul style="list-style-type: none"> Scene Group 1 Function <input checked="" type="checkbox"/> Scene Group 2 Function <input checked="" type="checkbox"/> Scene Group 3 Function <input checked="" type="checkbox"/> Scene Group 4 Function <input checked="" type="checkbox"/> Scene Group 5 Function <input checked="" type="checkbox"/> Scene Group 6 Function <input checked="" type="checkbox"/> Scene Group 7 Function <input checked="" type="checkbox"/> Scene Group 8 Function <input checked="" type="checkbox"/>
--	--

--- KNX Smart Touch with push button&Secure,3-gang > Scene group function > Group 1

<ul style="list-style-type: none"> KNX Secure + General + Home page + Function page setting Internal temperature measurement + Input 	<ul style="list-style-type: none"> Output 1 Function <input checked="" type="checkbox"/> Output 2 Function <input checked="" type="checkbox"/> Output 3 Function <input checked="" type="checkbox"/> Output 4 Function <input checked="" type="checkbox"/> Output 5 Function <input checked="" type="checkbox"/> Output 6 Function <input checked="" type="checkbox"/> Output 7 Function <input checked="" type="checkbox"/> Output 8 Function <input checked="" type="checkbox"/>
--	--

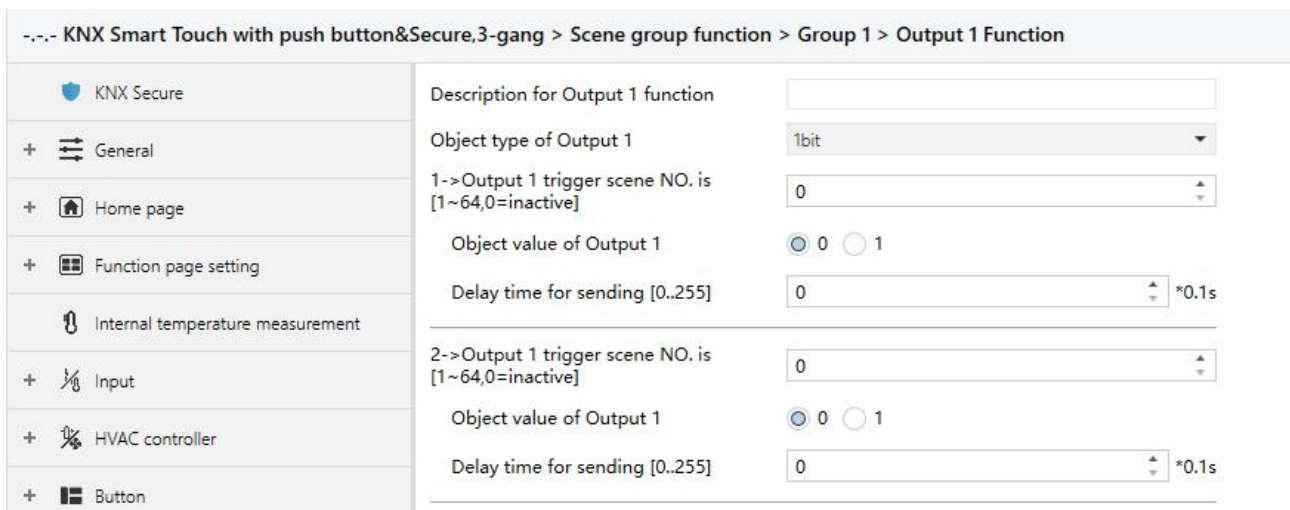

Fig.5.10 "Scene Group" parameter window

Parameter "Scene Group x Function" (x=1~8)

This parameter is for setting whether to enable scene group x function, up to 8 scene groups.

Parameter "Output y Function" (y=1~8)

This parameter is for setting whether to enable output y of scene group x, up to 8 output functions for each scene group.

As 8 group functions are the same, and 8 output functions of each group as well, the following description only about one output of a group.

Parameter "Description for Output y function" (y=1~8)

This parameter is for setting the name description for output y of group x, up to input 30 characters.

Parameter "Object type of Output y" (y=1~8)

This parameter is for setting the object type of output y of group x. Options:

- 1bit**
- 1byte**
- 2byte**

Parameter "Object datatype"

This parameter is for setting the datatype of 1byte or 2byte.

When the datatype is 1byte, options:

- 1byte unsigned value**

HVAC mode

When the datatype is 2byte, options:

2byte unsigned value

Temperature value

Parameter "z->Output y trigger scene NO. is [1~64,0=inactive]" (z=1~8)

This parameter is for setting the triggered scene number of output y of group x. Up to 8 triggered scene of each output can be configured. Options:**0..64, 0=inactive**

——Parameter "Object value of Output y"

This parameter is for setting the output value, the range depends on the data type of output y.

When the datatype is 1bit, options: **0..1**

When the datatype is 1byte-1byte unsigned value, options: **0..255**

When the datatype is 1byte-HVAC mode, options:

Comfort mode

Standby mode

Economy mode

Frost/heat protection

When the datatype is 2byte-2byte unsigned value, options: **0..65535**

When the datatype is 2byte-Temperature value, options:

-5°C

-4°C

...

45°C

——Parameter "Delay time for sending [0..255]*0.1s"

This parameter is for setting the delay time for sending the output value to the bus. Options: **0..255**

Chapter 6 Description of Communication Object

The communication object is the medium to communicate other device on the bus, namely only the communication object can communicate with the bus.

NOTE: “C” in “Flag” column in the below table means enable the communication function of the object; “W” means value of object can be written from the bus; “R” means the value of the object can be read by the other devices; “T” means the object has the transmission function; “U” means the value of the object can be updated.

6.1. “General” Communication Object

Number	Name	Object Function	Description	Group Address	Length	C	R	W	T	U	Data Type	Priority
1	General	In operation			1 bit	C	R	-	T	-	switch	Low
2	General	Date			3 bytes	C	-	W	-	-	date	Low
3	General	Time			3 bytes	C	-	W	-	-	time of day	Low
4	General	Screen brightness			1 byte	C	-	W	-	-	percentage (0..100%)	Low
1006	Extension function	Screen locking			1 bit	C	-	W	-	-	enable	Low
1007	Extension function	Screen on/off			1 bit	C	-	W	-	-	switch	Low
1008	Extension function	Security 1 trigger,1bit value			1 bit	C	-	-	T	-	switch	Low
1009	Extension function	Security 2 trigger,1bit value			1 bit	C	-	-	T	-	switch	Low
1010	Extension function	Security 3 trigger,1bit value			1 bit	C	-	-	T	-	switch	Low
1011	Extension function	Night mode			1 bit	C	R	-	T	-	day/night	Low
1012	Extension function	Summer time status			1 bit	C	R	-	T	-	enable	Low
1013	Extension function	Dis/En Proximity function			1 bit	C	-	W	-	-	enable	Low
1015	Extension function	Proximity output			1 bit	C	-	-	T	-	switch	Low
1017	Extension function	Alarm acknowledge			1 bit	C	-	-	T	-	acknowledge	Low
1018	Extension function	Alarm message			14 bytes	C	-	W	-	-	Character String (ISO 88...	Low
1019	Extension function	Alarm input			1 bit	C	-	W	T	U	alarm	Low
1020	Screensaver-Items 1	PM2.5 value			2 bytes	C	-	W	T	U	pulses	Low
1021	Screensaver-Items 2	VOC value			2 bytes	C	-	W	T	U	pulses	Low
1022	Screensaver-Items 3	VOC value			2 bytes	C	-	W	T	U	pulses	Low
1023	Screensaver-Items 4	PM2.5 value			2 bytes	C	-	W	T	U	pulses	Low
1014	Extension function	Proximity input			1 bit	C	-	W	-	-	switch	Low

Fig.6.1 “General” communication object

NO.	Object Function	Name	Data Type	Flag	DPT
1	In operation	General	1bit	C,R,T	1.001 switch
The communication object is used to periodically send a telegram “1” to the bus to indicate that the device is working properly.					
2	Date	General	3bytes	C,W	11.001 date
The communication object is used to modify the display date on the screen through the bus.					
3	Time	General	3bytes	C,W	10.001 time of day
The communication object is used to modify the display time on the screen through the bus.					

4	Screen brightness	General	1byte	C,W	5.001 percentage(0..100%)
<p>The communication object is used to modify the screen brightness under the current mode status. For example, if current is normal status, only update the brightness under the normal status, and brightness in the night status is still determined by its parameter; if modify when screen saver, only modify the brightness under the screen saver.</p> <p>Brightness output range: 10~100%, when the telegram value is less than 10%, directly output 10% brightness.</p>					
1006	Screen locking	Extension function	1bit	C,W	1.003 enable
<p>The communication object is used to lock the screen. After screen locked, the operation on the screen will not be responded, but can still receive the bus telegram. Telegram value:</p> <p>0 ---Lock</p> <p>1 ---Unlock</p>					
1007	Screen on/off	Extension function	1bit	C,W	1.001 switch
<p>The communication object is used to receive the telegrams from bus to control screen on/off, or control LED indicate at the same time. Telegram value:</p> <p>0 ---Off</p> <p>1 ---On</p>					
1008/ 1009/ 1010	Security 1/2/3 trigger,1bit value Security 1/2/3 trigger,1byte value Security 1/2/3 trigger,scene NO.	Extension function	1bit 1byte	C,T	1.001 switch 5.010 counter pulses 5.001 percentage 17.001 scene number
<p>These communication objects are visible when wake-up password function is enabled and output value is selected. The range of value is determined by the selected data type.</p>					
1011	Night mode	Extension function	1bit	C,R,T C,W,T	1.024 day/night

This communication object is used to send day/night status to the bus. Telegram value:

0 --- Day

1 --- Night

The object flag is C,W,T when the day/night status is switched according to the object, receive the telegram value via bus to switch;

The object flag is C,R,T when the day/night status is switched according to the time point or sunrise and sunset time, can not receive the telegram value via bus to switch.

1012	Summer time status	Extension function	1bit	C,R,T	1.003 enable
-------------	---------------------------	---------------------------	-------------	--------------	---------------------

The communication object is used to send the status telegrams of the summer time to the bus. Telegrams:

1 --- Summer time enable

0 --- Summer time disable

1013	Dis/En Proximity function	Extension function	1bit	C,W	1.003 enable
-------------	----------------------------------	---------------------------	-------------	------------	---------------------

The communication object is used to enable/disable proximity function.

1014	Proximity input	Extension function	1bit	C,W	1.001 switch
-------------	------------------------	---------------------------	-------------	------------	---------------------

The communication object is visible when proximity function is triggered by the object. Receive the telegram value from bus:

1---Trigger proximity function

0---Leaving (No proximity)

1015	Proximity output	Extension function	1bit 1byte	C,T	1.001 switch 5.010 counter pulses 17.001 scene number 5.001 percentage
-------------	-------------------------	---------------------------	-----------------------------	------------	---

The communication object is determined by the parameter "Object type of output value". When detect the reaction for proximity approaching/leaving, the object can send the parameter setting value(1 byte) or ON(1 bit) to the bus separately. The range of value is determined by the selected data type.

1017	Alarm acknowledge	Extension function	1bit	C,T	1.016 acknowledge
<p>When the user clicks on the screen to acknowledge the warning message, the communication object sends an acknowledge telegram to the bus, and the telegram value is 1.</p>					
1018	Alarm message	Extension function	14byte	C,W	16.001 character string (ISO 8859-1)
<p>The communication object is used to receive the warning message displayed on the screen from bus. When no value is received initially, the warning pop-up is displayed empty.</p>					
1019	Alarm input	Extension function	1bit	C,W,T,U	1.005 alarm
<p>The communication object is used to receive the alarm signal from bus, and send request when voltage recovery. Telegrams:</p> <p style="margin-left: 40px;">0 --- Remove alarm</p> <p style="margin-left: 40px;">1 --- Alarm</p>					
1020	Temperature value	Screensaver-Items 1	2byte	C,W,T,U	9.001 temperature
<p>The communication object is used for receiving a temperature measurement value sent from a external temperature sensor, the corresponding value got from the bus is updated to screen display.</p> <p>Range: -40...40°C</p>					
1020	Humidity value	Screensaver-Items 1	2byte	C,W,T,U	9.007 humidity
<p>The communication object is used for receiving a humidity measurement value sent from a external humidity sensor, the corresponding value got from the bus is updated to screen display.</p> <p>Range: 0~100%</p>					
1020	PM2.5/PM10/VOC value	Screensaver-Items 1	2byte	C,W,T,U	7.001 pulse 9.030 concentration(ug/m3)
<p>The communication object is used to receive the measurement value of the PM2.5/PM10/VOC value and get the corresponding value from the bus to be updated to the display in ug/m³. Range: 0~999ug/m³, object datatype is determined by the parameter setting.</p>					
1020	CO2 value	Screensaver-Items 1	2byte	C,W,T,U	7.001 pulse 9.008 parts/million(ppm)
<p>The communication object is used to receive the measurement value of the CO2 value and get the corresponding value from the bus to be updated to the display in ppm. Range: 0~4000ppm, object datatype is determined by the parameter setting.</p>					

1020	Brightness value	Screensaver-Items 1	2byte	C,W,T,U	7.013 brightness(lux) 9.004 lux
<p>The communication object is used to receive the measurement value of the brightness value and get the corresponding value from the bus to be updated to the display in lux. Range: 0~65535lux, object datatype is determined by the parameter setting.</p>					
1020	Wind speed	Screensaver-Items 1	2byte	C,W,T,U	9.005 speed 9.028 wind speed
<p>The communication object is used to receive the measurement value of the wind speed value and get the corresponding value from the bus to be updated to the display in m/s or km/h. Object datatype is determined by the parameter setting.</p>					
1020	AQI value	Screensaver-Items 1	2byte	C,W,T,U	7.001 pulse
<p>The communication object is used to receive the measurement value of the AQI value and get the corresponding value from the bus to be updated to the display. Range: 0~500</p>					
1020	Rain state	Screensaver-Items 1	1bit	C,W,T,U	1.001 switch
<p>The communication object is used to receive telegram of the rain state and get the corresponding value from the bus to be updated to the display. Telegram:</p> <p style="padding-left: 40px;">1—Rain</p> <p style="padding-left: 40px;">0—No rain</p>					

Table 6.1 "General" communication object table

6.2. "Internal sensor" Communication Object

Numbe	Name	Object Function	Description	Group Address	Length	C	R	W	T	U	Data Type	Priority
5	Internal sensor	Temperature value			2 bytes	C	R	-	T	-	temperature (°C)	Low
6	Internal sensor	Low temperature alarm			1 bit	C	R	-	T	-	alarm	Low
7	Internal sensor	High temperature alarm			1 bit	C	R	-	T	-	alarm	Low
8	Internal sensor	Humidity value			2 bytes	C	R	-	T	-	humidity (%)	Low
9	Internal sensor	Low humidity alarm			1 bit	C	R	-	T	-	alarm	Low
10	Internal sensor	High humidity alarm			1 bit	C	R	-	T	-	alarm	Low

Fig.6.2 "Internal sensor" communication object

NO.	Object Function	Name	Data Type	Flag	DPT
5	Temperature value	Internal sensor	2bytes	C,R,T	9.001 temperature
The communication object is used for transmitting the temperature value detected by the built-in temperature sensor of the device to the bus. Range:-50~99.8°C					
6	Low temperature alarm	Internal sensor	1bit	C,R,T	1.005 alarm
The communication object is used to send the low temperature alarm signal to bus, when temperature lower than low threshold that defined by parameter.					
7	High temperature alarm	Internal sensor	1bit	C,R,T	1.005 alarm
The communication object is used to send the high temperature alarm signal to bus, when temperature higher than high threshold that defined by parameter.					
8	Humidity value	Internal sensor	2bytes	C,R,T	9.007 humidity
The communication object is used to receive humidity measurements sent from the humidity sensor on the bus. Range:0~100%					
9	Low humidity alarm	Internal sensor	1bit	C,R,T	1.005 alarm
The communication object is used to send the low humidity alarm signal to bus, when humidity lower than low threshold that defined by parameter.					
10	High humidity alarm	Internal sensor	1bit	C,R,T	1.005 alarm
The communication object is used to send the high humidity alarm signal to bus, when humidity higher than high threshold that defined by parameter.					

Table 6.2 "Internal sensor" communication object table

6.3. "Input" Communication Object

Numbe	Name	Object Function	Description	Group Address	Length	C	R	W	T	U	Data Type	Priority
1000	Input 1 - Temperature probe	Actual temperature, Sensor			2 bytes	C	R	-	T	-	temperature (°C)	Low
1001	Input 1 - Temperature probe	Temperature error report, Sensor			1 bit	C	R	-	T	-	alarm	Low

Temperature probe

Numbe	Name	Object Function	Description	Group Address	Length	C	R	W	T	U	Data Type	Priority
1000	Input 1 - Switch sensor	Switch			1 bit	C	-	W	T	U	switch	Low
1000	Input 1 - Switch sensor	Close, Switch			1 bit	C	-	W	T	U	switch	Low
1001	Input 1 - Switch sensor	Open, Switch			1 bit	C	-	W	T	U	switch	Low
1000	Input 1 - Switch sensor	Short, Switch			1 bit	C	-	W	T	U	switch	Low
1001	Input 1 - Switch sensor	Long, Switch			1 bit	C	-	W	T	U	switch	Low
1002	Input 1 - Switch sensor	Disable			1 bit	C	-	W	-	-	enable	Low

BI: Switch sensor

Numbe	Name	Object Function	Description	Group Address	Length	C	R	W	T	U	Data Type	Priority
1000	Input 1 - Scene control	Scene			1 byte	C	-	-	T	-	scene control	Low
1000	Input 1 - Scene control	Close, Scene			1 byte	C	-	-	T	-	scene control	Low
1001	Input 1 - Scene control	Open, Scene			1 byte	C	-	-	T	-	scene control	Low
1000	Input 1 - Scene control	Short, Scene			1 byte	C	-	-	T	-	scene control	Low
1001	Input 1 - Scene control	Long, Scene			1 byte	C	-	-	T	-	scene control	Low
1002	Input 1 - Scene control	Disable			1 bit	C	-	W	-	-	enable	Low

BI: Scene control

Numbe	Name	Object Function	Description	Group Ad	Length	C	R	W	T	U	Data Type	Priority
1000	Input 1 - Send String	String			14 bytes	C	-	-	T	-	Character String (ISO 8859-1)	Low
1000	Input 1 - Send String	Close, String			14 bytes	C	-	-	T	-	Character String (ISO 8859-1)	Low
1001	Input 1 - Send String	Open, String			14 bytes	C	-	-	T	-	Character String (ISO 8859-1)	Low
1000	Input 1 - Send String	Short, String			14 bytes	C	-	-	T	-	Character String (ISO 8859-1)	Low
1001	Input 1 - Send String	Long, String			14 bytes	C	-	-	T	-	Character String (ISO 8859-1)	Low
1002	Input 1 - Send String	Disable			1 bit	C	-	W	-	-	enable	Low

BI: Send string

Fig.6.3 "Input" communication object

NO.	Object Function	Name	Data Type	Flag	DPT
1000	Actual temperature, Sensor	Input 1 - {{Temperature probe}}	2bytes	C,R,T	9.001 temperature
<p>The communication object is used for transmitting the temperature value detected by the external temperature sensor of the device to the bus. Range:-50~99.8°C</p> <p>The name in parentheses changes with the parameter "Description (max 30 char.)". If description is empty, display "Input x - ..." by default. The same below.</p>					
1001	Temperature error report, Sensor	Input 1 - {{Temperature probe}}	1bit	C,R,T	1.005 alarm
<p>The communication object is used to send the error report of the external temperature sensor, and the object value is defined according to the parameters.</p>					
1000	Switch	Input 1 - {{Switch sensor}}	1bit	C,W,T,U	1.001 switch
1000	Close/Short, Switch	Input 1 - {{Switch sensor}}	1bit	C,W,T,U	1.001 switch
1001	Open/Long, Switch	Input 1 - {{Switch sensor}}	1bit	C,W,T,U	1.001 switch

These communication objects are used to trigger a switching operation. Use a common object or two separate objects is according to the parameter setting.

Only the object "Switch" is visible when use a common object. If use two separate objects, "Close/Open" is visible when there is no distinction for short/long operation; "Short/Long" is visible when there is distinction for short/long operation. Telegrams:

0—Off

1—On

1000	Scene	Input 1 - {{Scene control}}	1byte	C,T	18.001 scene control
1000	Close/Short, Scene	Input 1 - {{Scene control}}	1byte	C,T	18.001 scene control
1001	Open/Long, Scene	Input 1 - {{Scene control}}	1byte	C,T	18.001 scene control

These communication objects are used to send a 8 bit command to recall or storage scene. Use a common object or two separate objects is according to the parameter setting.

Only the object "Scene" is visible when use a common object. If use two separate objects, "Close/Open" is visible when there is no distinction for short/long operation; "Short/Long" is visible when there is distinction for short/long operation. Telegrams:

Detailed 8bit the meaning of the directive.

Set up a 8bit Orders for the (Binary code): FXNNNNNN

F: '0' recall scene; '1' for storage scene;

X : 0 ;

NNNNNN: Scene number(0... 63).

As follows:

Object message value	Description
0	Recall scene 1
1	Recall scene 2
2	Recall scene 3
...	...
63	Recall scene 64
128	Store scene 1
129	Store scene 2
130	Store scene 3
...	...
191	Store scene 64

Parameter setting Options are 1~64, actually communication object "Scene" corresponds to the telegram received is 0~63 . Such as parameter settings is the scene 1, communication object "Scene" sends the scene for 0.

1000	String	Input 1 - {{Send String}}	14byte	C,T	16.001 character string (ISO 8859-1)
1000	Close/Short, String	Input 1 - {{Send String}}	14byte	C,T	16.001 character string (ISO 8859-1)
1001	Open/Long, String	Input 1 - {{Send String}}	14byte	C,T	16.001 character string (ISO 8859-1)
<p>These communication objects are used to send the sting to bus. Use a common object or two separate objects is according to the parameter setting.</p> <p>Only the object "String" is visible when use a common object. If use two separate objects, "Close/Open" is visible when there is no distinction for short/long operation; "Short/Long" is visible when there is distinction for short/long operation.</p>					
1002	Disable	Input 1 - {...}	1bit	C,W	1.003 enable
<p>The communication object is used to disable/enable the function of contact input, apply to binary input function, including switch, scene and send string.</p>					

Table 6.3 "Input" communication object table

6.4. "HVAC controller" Communication Object

6.4.1. "Room temperature controller" Communication Object

Number *	Name	Object Function	Description	Group Address	Length	C	R	W	T	U	Data Type	Priority
148	Controller 1 - RTC	Power on/off			1 bit	C	R	W	-	-	switch	Low
149	Controller 1 - RTC	External temperature sensor			2 bytes	C	-	W	T	U	temperature (°C)	Low
150	Controller 1 - RTC	Base setpoint adjustment			2 bytes	C	-	W	-	-	temperature (°C)	Low
151	Controller 1 - RTC	Setpoint offset			1 bit	C	-	W	-	-	step	Low
152	Controller 1 - RTC	Float offset value			2 bytes	C	-	W	-	-	temperature difference (K)	Low
153	Controller 1 - RTC	Setpoint offset reset			1 bit	C	-	W	-	-	reset	Low
154	Controller 1 - RTC	Heating/Cooling mode			1 bit	C	-	W	-	-	cooling/heating	Low
155	Controller 1 - RTC	Operation mode			1 byte	C	-	W	-	-	HVAC mode	Low
156	Controller 1 - RTC	Comfort mode			1 bit	C	-	W	-	-	enable	Low
157	Controller 1 - RTC	Economy mode			1 bit	C	-	W	-	-	enable	Low
158	Controller 1 - RTC	Frost/Heat protection mode			1 bit	C	-	W	-	-	enable	Low
159	Controller 1 - RTC	Standby mode			1 bit	C	-	W	-	-	enable	Low
160	Controller 1 - RTC	Extended comfort mode			1 bit	C	-	W	-	-	acknowledge	Low
161	Controller 1 - RTC	Fan automatic operation			1 bit	C	-	W	-	-	enable	Low
162	Controller 1 - RTC	Window contact			1 bit	C	-	W	-	U	window/door	Low
163	Controller 1 - RTC	Presence detector			1 bit	C	-	W	-	U	occupancy	Low
164	Controller 1 - RTC	Actual temperature, status			2 bytes	C	R	-	T	-	temperature (°C)	Low
165	Controller 1 - RTC	Base temperature setpoint, status			2 bytes	C	R	-	T	-	temperature (°C)	Low
166	Controller 1 - RTC	Setpoint offset, status			2 bytes	C	R	-	T	-	temperature difference (K)	Low
167	Controller 1 - RTC	Current temperature setpoint, status			2 bytes	C	R	-	T	-	temperature (°C)	Low
168	Controller 1 - RTC	Heating/Cooling mode, status			1 bit	C	R	-	T	-	cooling/heating	Low
169	Controller 1 - RTC	Operation mode, status			1 byte	C	R	-	T	-	HVAC mode	Low
170	Controller 1 - RTC	Comfort mode, status			1 bit	C	R	-	T	-	enable	Low
171	Controller 1 - RTC	Economy mode, status			1 bit	C	R	-	T	-	enable	Low
172	Controller 1 - RTC	Frost/Heat protection mode, status			1 bit	C	R	-	T	-	enable	Low
173	Controller 1 - RTC	Standby mode, status			1 bit	C	R	-	T	-	enable	Low
174	Controller 1 - RTC	Heating control value			1 bit	C	R	-	T	-	switch	Low
175	Controller 1 - RTC	Cooling control value			1 bit	C	R	-	T	-	switch	Low
176	Controller 1 - RTC	Fan speed			1 byte	C	-	-	T	-	percentage (0..100%)	Low
177	Controller 1 - RTC	Fan speed low			1 bit	C	-	-	T	-	switch	Low
178	Controller 1 - RTC	Fan speed medium			1 bit	C	-	-	T	-	switch	Low
179	Controller 1 - RTC	Fan speed high			1 bit	C	-	-	T	-	switch	Low
180	Controller 1 - RTC	Fan speed off			1 bit	C	-	-	T	-	switch	Low

Fig.6.4.1 "Room temperature controller" communication object

NO.	Object Function	Name	Data Type	Flag	DPT
148	Power on/off	Controller 1 - {{RTC}}	1bit	C,W,R	1.001 switch
<p>The communication object is used to receive the telegram from the bus to control RTC power on/off. Telegrams:</p> <p style="text-align: center;">1—On</p> <p style="text-align: center;">0—Off</p> <p>The name in parentheses changes with the parameter "Description (max 30 char.)". If description is empty, display "Controller 1 - ..." by default. The same below.</p>					
149	External temperature sensor	Controller 1 - {{RTC}}	2bytes	C,W,T,U	9.001 temperature
<p>The communication object is used to receive the temperature value detected by the temperature sensor of the device form the bus. Range:-50~99.8°C</p>					

150	Current setpoint adjustment Base setpoint adjustment	Controller 1 - {{RTC}}	2bytes	C,W	9.001 temperature
<p>“Current setpoint adjustment” is visible when operation mode is not enabled, and under absolute adjustment. Used to modify the base value of the set temperature; and to modify set temperature value of current room operation mode when absolute adjustment.</p> <p>“Base setpoint adjustment” is visible only when relative adjustment, used to modify the base value of the set temperature, that is, the temperature setting value of the comfort mode, and the setting temperature of the standby mode and the economy mode changes according to the relative change. In the protection mode, only the temperature setting value of the protection mode is modified.</p>					
151	Setpoint offset	Controller 1 - {{RTC}}	1bit	C,W	1.007 step
<p>The communication object is visible only when absolute adjustment, and offset function enabled. Used to adjust the offset to adjust setpoint temperature indirectly. The step value set according to the parameter. Telegrams:</p> <p style="padding-left: 40px;">1 —Increase the offset in the forward direction</p> <p style="padding-left: 40px;">0 —Decrease the offset in the negative direction</p>					
152	Float offset value	Controller 1 - {{RTC}}	2bytes	C,W	9.002 temperature difference
<p>The communication object is visible only when absolute adjustment, and offset function enabled. Used to modify the accumulated offset via 2 byte float value.</p>					
153	Setpoint offset reset	Controller 1 - {{RTC}}	1bit	C,W	1.015 reset
<p>The communication object is visible only when absolute adjustment, and offset function enabled. Reset offset value when telegram is 1.</p>					
154	Heating/Cooling mode	Controller 1 - {{RTC}}	1bit	C,W	1.100 cooling/heating
<p>The communication object is used for switching the heating and cooling via the bus. Telegrams:</p> <p style="padding-left: 40px;">1 —Heating</p> <p style="padding-left: 40px;">0 —Cooling</p>					
155	Operation mode	Controller 1 - {{RTC}}	1byte	C,W	20.102 HVAC mode
156	Comfort mode	Controller 1 - {{RTC}}	1bit	C,W	1.003 enable
157	Economy mode	Controller 1 - {{RTC}}	1bit	C,W	1.003 enable

158	Frost/Heat protection mode	Controller 1 - {{RTC}}	1bit	C,W	1.003 enable
159	Standby mode	Controller 1 - {{RTC}}	1bit	C,W	1.003 enable
<p>These communication objects are used to control the RTC operation mode via the bus.</p> <p>When 1 byte: object 155 is visible, telegrams: 1-comfort, 2-standby, 3-economy, 4-protection, other reserved.</p> <p>When 1bit:</p> <p style="padding-left: 40px;">Object 156— Comfort mode</p> <p style="padding-left: 40px;">Object 157— Standby mode</p> <p style="padding-left: 40px;">Object 158— Economy mode</p> <p style="padding-left: 40px;">Object 159— Protection mode</p> <p>When the object receives the telegram “1”, the corresponding mode is activated. When 1 bit standby object is not enable, and the telegrams of comfort, economy, protection mode are 0, is standby mode. When 1 bit standby object is enable, standby object receives “1” activates standby mode, 0 is no processing.</p>					
160	Extended comfort mode	Controller 1 - {{RTC}}	1bit	C,W	1.016 acknowledge
<p>The communication object is used for triggering time to extended comfort mode. Telegrams:</p> <p style="padding-left: 40px;">1— Activate comfort mode</p> <p style="padding-left: 40px;">0— No sense</p> <p>Activate comfort mode when the object receives telegram 1. If receive again telegram 1 in delay time, time will be timed again. And return the previous operation mode from comfort mode once finish timing. If there is a new operation mode in delay time, exit the comfort mode.</p> <p>If a switch operation, exit the timing, but switch the heating/cooling will not.</p>					
161	Fan automatic operation	Controller 1 - {{RTC}}	1bit	C,W	1.003 enable
<p>The communication object is used to activate the fan automatic operation via the bus. Telegram:</p> <p style="padding-left: 40px;">1— Auto</p> <p style="padding-left: 40px;">0— Exit auto</p>					

162	Window contact	Controller 1 - {{RTC}}	1bit	C,W,U	1.019 Window/door
<p>The communication object is used to receive the switch status of window contact. Telegrams:</p> <p>1—Open window</p> <p>0—Close window</p>					
163	Presence detector	Controller 1 - {{RTC}}	1bit	C,W,U	1.018 occupancy
<p>The communication object is used to receive the room occupancy status from presence detector. Telegrams:</p> <p>1—Some one</p> <p>0—No one</p>					
164	Actual temperature, status	Controller 1 - {{RTC}}	2byte s	C,R,T	9.001 temperature
<p>The communication object is visible when temperature reference of RTC function is combination of internal and external sensor. Used to send the actual temperature after the combination to the bus.</p>					
165	Base temperature setpoint, status	Controller 1 - {{RTC}}	2byte s	C,R,T	9.001 temperature
<p>The communication object is visible only when relative adjustment. Used to send the current base set temperature to the bus.</p> <p>Current base set temperature value = parameter set value (or object 150 base value)+accumulated offset value</p>					
166	Setpoint offset, status	Controller 1 - {{RTC}}	2byte s	C,R,T	9.002 temperature diffenerece
<p>The communication object is visible only when relative adjustment. Used to send the accumulated offset value of base set temperature to the bus.</p>					
167	Current temperature setpoint, status	Controller 1 - {{RTC}}	2byte s	C,R,T	9.001 temperature
<p>The communication object is used to send current set temperature to the bus.</p>					

168	Heating/Cooling mode, status	Controller 1 - {{RTC}}	1bit	C,R,T	1.100 cooling/heating
<p>The communication object is used to feedback the telegram of switching cooling and heating function to the bus.</p>					
169	Operation mode, status	Controller 1 - {{RTC}}	1byte	C,R,T	20.102 HVAC mode
170	Comfort mode, status	Controller 1 - {{RTC}}	1bit	C,R,T	1.003 enable
171	Economy mode, status	Controller 1 - {{RTC}}	1bit	C,R,T	1.003 enable
172	Frost/Heat protection mode, status	Controller 1 - {{RTC}}	1bit	C,R,T	1.003 enable
173	Standby mode, status	Controller 1 - {{RTC}}	1bit	C,R,T	1.003 enable
<p>These communication objects are used to send RTC operation mode status to the bus.</p> <p>When 1 byte: object 169 is visible, telegrams: 1-comfort, 2-standby, 3-economy, 4-protection, other reserved.</p> <p>When 1bit:</p> <p style="padding-left: 40px;">Object 170— Comfort mode</p> <p style="padding-left: 40px;">Object 171— Economy mode</p> <p style="padding-left: 40px;">Object 172— Protection mode</p> <p style="padding-left: 40px;">Object 173— Standby mode</p> <p>When a mode is activated, the corresponding object only sends telegram “1”. When 1 bit standby object is not enable, activate standby mode when comfort, economy, protection objects send telegram 0 together. When 1 bit standby object is enable, activate standby mode only when standby object send 1.</p>					
<p>Note: no requirement to send mode status to the bus when switchover via bus. The same is fan speed and other operation.</p>					
174	Heating control value, status	Controller 1 - {{RTC}}	1bit 1byte	C,R,T	1.001 Switch 5.001 percentage
175	Cooling control value, status	Controller 1 - {{RTC}}	1bit 1byte	C,R,T	1.001 Switch 5.001 percentage
<p>The communication object is used to send control value of heating or cooling function to the bus. Object datatype is according to parameter setting.</p>					

176	Fan speed, status	Controller 1 - {{RTC}}	1byte	C,T	5.001 percentage 5.100 fan stage
177	Fan speed low, status	Controller 1 - {{RTC}}	1bit	C,T	1.001 switch
178	Fan speed medium, status	Controller 1 - {{RTC}}	1bit	C,T	1.001 switch
179	Fan speed high, status	Controller 1 - {{RTC}}	1bit	C,T	1.001 switch
180	Fan speed off, status	Controller 1 - {{RTC}}	1bit	C,T	1.001 switch

These communication objects are used to send control telegrams of the fan speed to the bus.

1bit object is visible according to the parameter setting :

Object 177—Low fan speed

Object 178—Medium fan speed

Object 179—High fan speed

Object 180—Fan speed off

Only the corresponding object sends telegram “1” when switch to a certain fan speed. When 1bit-off object is not enable, all objects send telegrams “0” when switch to fan speed off (The situation apply to connect with fan actuator of GVS);

When 1bit-off object is enable, only 1bit-off object send telegram “1” (The situation apply to connect with fan actuator of other manufacturers).

1byte: the corresponding telegram value of each fan speed is defined by the parameter. Activate the corresponding fan speed on the screen, and object 176 sends the corresponding telegram value of the fan speed to the bus.

Table 6.4.1 “Room temperature controller” communication object table

6.4.2. "Ventilation controller" Communication Object

Number ^	Name	Object Function	Description	Group Address	Length	C	R	W	T	U	Data Type	Priority
148	Controller 1 - Ventilation	Fan automatic operation			1 bit	C	R	W	-	-	enable	Low
149	Controller 1 - Ventilation	CO2 value			2 bytes	C	-	W	T	U	parts/million (ppm)	Low
176	Controller 1 - Ventilation	Fan speed			1 byte	C	-	-	T	-	percentage (0..100%)	Low

Fig.6.4.2 "Ventilation controller" communication object

NO.	Object Function	Name	Data Type	Flag	DPT
148	Fan automatic operation	Controller 1 - {{Ventilation}}	1bit	C,W	1.003 enable
<p>The communication object is used to activate the fan automatic operation via the bus. Telegram:</p> <p style="text-align: center;">1—Auto</p> <p style="text-align: center;">0—Exit auto</p>					
149	PM 2.5 value VOC value CO2 value	Controller 1 - {{Ventilation}}	2bytes	C,W,T,U	7.001 pulse 9.030 concentration(ug/m3) 9.008 parts/million(ppm)
<p>The communication object is used to receive the input of the PM2.5/VOC/CO2 value and get the corresponding value from the bus to be updated to the display in ug/m³ or ppm. Range:0~999ug/m³ or 0~4000ppm</p> <p>If the control value of the automatic operation is PM2.5, the ventilation system can be set to automatically adjust the fan speed according to the concentration of PM2.5.</p>					
176	Fan speed, status	Controller 1 - {{Ventilation}}	1byte	C,T	5.001 percentage 5.100 fan stage
<p>The communication object is used to send the fan speed under auto control to the bus. Corresponding telegrams of each fan speed are determined by parameter setting.</p>					

Table 6.4.2 "Ventilation controller" communication object table

6.5. "Home page" Communication Object

Number	Name	Object Function	Description	Group Ad	Length	C	R	W	T	U	Data Type	Priority
348	Home - Icon 3	Ext.temperature value			2 bytes	C	-	W	T	U	temperature (°C)	Low
348	Home - Icon 3	Ext.humidity value			2 bytes	C	-	W	T	U	humidity (%)	Low
348	Home - Icon 3	PM2.5 value			2 bytes	C	-	W	T	U	pulses	Low
348	Home - Icon 3	PM10 value			2 bytes	C	-	W	T	U	pulses	Low
348	Home - Icon 3	VOC value			2 bytes	C	-	W	T	U	pulses	Low
348	Home - Icon 3	CO2 value			2 bytes	C	-	W	T	U	parts/million (ppm)	Low
348	Home - Icon 3	AQI value			2 bytes	C	-	W	T	U	pulses	Low
348	Home - Icon 3	Brightness value			2 bytes	C	-	W	T	U	lux (Lux)	Low
348	Home - Icon 3	Wind speed			2 bytes	C	-	W	T	U	speed (m/s)	Low
348	Home - Icon 3	Rain state			1 bit	C	-	W	T	U	switch	Low
348	Home - Icon 3	Scene			1 byte	C	-	-	T	-	scene control	Low

Fig.6.5 "Home page" communication object

NO.	Object Function	Name	Data Type	Flag	DPT
348	Ext.temperature value	Home - {{Icon 3}}	2bytes	C,W,T,U	9.001 temperature
<p>The communication object is used for receiving a temperature measurement value sent from a external temperature sensor, the corresponding value got from the bus is updated to screen display.</p> <p>The name in parentheses changes with the parameter "Description (max 15 char.)". If description is empty, display "Home - Icon x" by default. The same below.</p>					
348	Ext.humidity value	Home - {{Icon 3}}	2bytes	C,W,T,U	9.007 humidity
<p>The communication object is used for receiving a humidity measurement value sent from a external humidity sensor, the corresponding value got from the bus is updated to screen display. Range: 0~100%</p>					
348	PM2.5 value PM10 value VOC value	Home - {{Icon 3}}	2bytes	C,W,T,U	7.001 pulse 9.030 concentration(ug/m3)
<p>The communication object is used to receive the measurement value of the PM2.5/PM10/VOC value and get the corresponding value from the bus to be updated to the display in ug/m³. Range: 0~999ug/m³, object datatype is determined by the parameter setting.</p>					
348	CO2 value	Home - {{Icon 3}}	2bytes	C,W,T,U	7.001 pulse 9.008 parts/million(ppm)
<p>The communication object is used to receive the measurement value of the CO2 value and get the corresponding value from the bus to be updated to the display in ppm. Range: 0~4000ppm, object datatype is determined by the parameter setting.</p>					
348	AQI value	Home - {{Icon 3}}	2bytes	C,W,T,U	7.001 pulse
<p>The communication object is used to receive the measurement value of the AQI value and get the corresponding value from the bus to be updated to the display. Range: 0~500</p>					





348	Brightness value	Home - 	2bytes	C,W,T,U	7.013 brightness(lux) 9.004 lux
<p>The communication object is used to receive the measurement value of the brightness value and get the corresponding value from the bus to be updated to the display in lux. Range: 0~65535lux, object datatype is determined by the parameter setting.</p>					
348	Wind speed	Home - 	2bytes	C,W,T,U	9.005 speed 9.028 wind speed
<p>The communication object is used to receive the measurement value of the wind speed value and get the corresponding value from the bus to be updated to the display in m/s or km/h. Object datatype is determined by the parameter setting.</p>					
348	Rain state	Home - 	1bit	C,W,T,U	1.001 switch
<p>The communication object is used to receive telegram of the rain state and get the corresponding value from the bus to be updated to the display. Telegram:</p> <p style="text-align: center;">1——Rain</p> <p style="text-align: center;">0——No rain</p>					
348	Scene	Home - 	2bytes	C,T C,W,T	18.001 scene control
<p>The communication object is used to send the telegram of scene recall or storage. The highest bit 1 is the scene storage, and the highest bit 0 is the scene recall.</p> <p>Short press the icon to recall scene, and long press is optional whether to storage scene.</p> <p>The flag is C,W,T when enable the object with status feedback; the flag is C,T, when disable.</p>					

Table 6.5 “Home page” communication object table

6.6. "Function page setting" Communication Object

6.6.1. Communication Object of Basic function

Numbe	Name	Object Function	Description	Group Ad	Length	C	R	W	T	U	Data Type	Priority
352	Page 1 - Icon 1	Locking object			1 bit	C	-	W	-	-	enable	Low
353	Page 1 - Icon 1	Switch			1 bit	C	-	-	T	-	switch	Low
358	Page 1 - Icon 1	Switch, status			1 bit	C	-	W	T	U	switch	Low

Switch

Number	Name	Object Function	Description	Group Address	Length	C	R	W	T	U	Data Type	Priority
352	Page 1 - Icon 1	Locking object			1 bit	C	-	W	-	-	enable	Low
353	Page 1 - Icon 1	Switch			1 bit	C	-	-	T	-	switch	Low

Press/Release switch

Numbe	Name	Object Function	Description	Group Ad	Length	C	R	W	T	U	Data Type	Priority
352	Page 1 - Icon 1	Locking object			1 bit	C	-	W	-	-	enable	Low
353	Page 1 - Icon 1	Switch			1 bit	C	-	-	T	-	switch	Low
354	Page 1 - Icon 1	Relative dimming			4 bit	C	-	-	T	-	dimming control	Low
358	Page 1 - Icon 1	Switch, status			1 bit	C	-	W	T	U	switch	Low

Relative dimming

Numbe	Name	Object Function	Description	Group Ad	Length	C	R	W	T	U	Data Type	Priority
352	Page 1 - Icon 1	Locking object			1 bit	C	-	W	-	-	enable	Low
353	Page 1 - Icon 1	Switch			1 bit	C	-	-	T	-	switch	Low
354	Page 1 - Icon 1	Relative dimming			4 bit	C	-	-	T	-	dimming control	Low
355	Page 1 - Icon 1	Brightness dimming			1 byte	C	-	-	T	-	percentage (0..100%)	Low
358	Page 1 - Icon 1	Switch, status			1 bit	C	-	W	T	U	switch	Low
360	Page 1 - Icon 1	Brightness, status			1 byte	C	-	W	T	U	percentage (0..100%)	Low

Brightness dimming

Numbe	Name	Object Function	Description	Group Ad	Length	C	R	W	T	U	Data Type	Priority
352	Page 1 - Icon 1	Locking object			1 bit	C	-	W	-	-	enable	Low
353	Page 1 - Icon 1	Switch			1 bit	C	-	-	T	-	switch	Low
354	Page 1 - Icon 1	RGB dimming value			3 bytes	C	-	-	T	-	RGB value 3x(0..255)	Low
358	Page 1 - Icon 1	Switch, status			1 bit	C	-	W	T	U	switch	Low
359	Page 1 - Icon 1	RGB brightness, status			3 bytes	C	-	W	T	U	RGB value 3x(0..255)	Low
354	Page 1 - Icon 1	Red dimming value			1 byte	C	-	-	T	-	percentage (0..100%)	Low
355	Page 1 - Icon 1	Green dimming value			1 byte	C	-	-	T	-	percentage (0..100%)	Low
356	Page 1 - Icon 1	Blue dimming value			1 byte	C	-	-	T	-	percentage (0..100%)	Low
359	Page 1 - Icon 1	Red brightness, status			1 byte	C	-	W	T	U	percentage (0..100%)	Low
360	Page 1 - Icon 1	Green brightness, status			1 byte	C	-	W	T	U	percentage (0..100%)	Low
361	Page 1 - Icon 1	Blue brightness, status			1 byte	C	-	W	T	U	percentage (0..100%)	Low

RGB dimming

Numbe	Name	Object Function	Description	Group Ad	Length	C	R	W	T	U	Data Type	Priority
352	Page 1 - Icon 1	Locking object			1 bit	C	-	W	-	-	enable	Low
353	Page 1 - Icon 1	Switch			1 bit	C	-	-	T	-	switch	Low
354	Page 1 - Icon 1	RGBW dimming value			6 bytes	C	-	-	T	-	RGBW value 4x(0..100%)	Low
358	Page 1 - Icon 1	Switch, status			1 bit	C	-	W	T	U	switch	Low
359	Page 1 - Icon 1	RGBW brightness, status			6 bytes	C	-	W	T	U	RGBW value 4x(0..100%)	Low
354	Page 1 - Icon 1	Red dimming value			1 byte	C	-	-	T	-	percentage (0..100%)	Low
355	Page 1 - Icon 1	Green dimming value			1 byte	C	-	-	T	-	percentage (0..100%)	Low
356	Page 1 - Icon 1	Blue dimming value			1 byte	C	-	-	T	-	percentage (0..100%)	Low
357	Page 1 - Icon 1	White dimming value			1 byte	C	-	-	T	-	percentage (0..100%)	Low
359	Page 1 - Icon 1	Red brightness, status			1 byte	C	-	W	T	U	percentage (0..100%)	Low
360	Page 1 - Icon 1	Green brightness, status			1 byte	C	-	W	T	U	percentage (0..100%)	Low
361	Page 1 - Icon 1	Blue brightness, status			1 byte	C	-	W	T	U	percentage (0..100%)	Low
362	Page 1 - Icon 1	White brightness, status			1 byte	C	-	W	T	U	percentage (0..100%)	Low

RGBW dimming

Numbe	Name	Object Function	Descript	Group Ad	Length	C	R	W	T	U	Data Type	Priority
352	Page 1 - Icon 1	Locking object			1 bit	C	-	W	-	-	enable	Low
353	Page 1 - Icon 1	Switch			1 bit	C	-	-	T	-	switch	Low
354	Page 1 - Icon 1	RGB dimming value			3 bytes	C	-	-	T	-	RGB value 3x(0..255)	Low
357	Page 1 - Icon 1	Colour temperature value			2 bytes	C	-	-	T	-	absolute colour temperature (K)	Low
358	Page 1 - Icon 1	Switch, status			1 bit	C	-	W	T	U	switch	Low
359	Page 1 - Icon 1	RGB brightness, status			3 bytes	C	-	W	T	U	RGB value 3x(0..255)	Low
362	Page 1 - Icon 1	Colour temperature, status			2 bytes	C	-	W	T	U	absolute colour temperature (K)	Low
363	Page 1 - Icon 1	Brightness value			1 byte	C	-	-	T	-	percentage (0..100%)	Low
365	Page 1 - Icon 1	Brightness, status			1 byte	C	-	W	T	U	percentage (0..100%)	Low

RGBCW dimming-Normal

Numbe	Name	Object Function	Descript	Group Ad	Length	C	R	W	T	U	Data Type	Priority
352	Page 1 - Icon 1	Locking object			1 bit	C	-	W	-	-	enable	Low
353	Page 1 - Icon 1	Switch			1 bit	C	-	-	T	-	switch	Low
354	Page 1 - Icon 1	Red dimming value			1 byte	C	-	-	T	-	percentage (0..100%)	Low
355	Page 1 - Icon 1	Green dimming value			1 byte	C	-	-	T	-	percentage (0..100%)	Low
356	Page 1 - Icon 1	Blue dimming value			1 byte	C	-	-	T	-	percentage (0..100%)	Low
358	Page 1 - Icon 1	Switch, status			1 bit	C	-	W	T	U	switch	Low
359	Page 1 - Icon 1	Red brightness, status			1 byte	C	-	W	T	U	percentage (0..100%)	Low
360	Page 1 - Icon 1	Green brightness, status			1 byte	C	-	W	T	U	percentage (0..100%)	Low
361	Page 1 - Icon 1	Blue brightness, status			1 byte	C	-	W	T	U	percentage (0..100%)	Low
362	Page 1 - Icon 1	Colour temperature, status			2 bytes	C	-	W	T	U	absolute colour temperature (K)	Low
363	Page 1 - Icon 1	Warm white brightness			1 byte	C	-	-	T	-	percentage (0..100%)	Low
364	Page 1 - Icon 1	Cool white brightness			1 byte	C	-	-	T	-	percentage (0..100%)	Low
365	Page 1 - Icon 1	Brightness, status			1 byte	C	-	W	T	U	percentage (0..100%)	Low

RGBCW dimming-Directly(..) &Brightness+Colour Temperature

Numbe	Name	Object Function	Descript	Group Ad	Length	C	R	W	T	U	Data Type	Priority
352	Page 1 - Icon 1	Locking object			1 bit	C	-	W	-	-	enable	Low
353	Page 1 - Icon 1	Switch			1 bit	C	-	-	T	-	switch	Low
354	Page 1 - Icon 1	Red dimming value			1 byte	C	-	-	T	-	percentage (0..100%)	Low
355	Page 1 - Icon 1	Green dimming value			1 byte	C	-	-	T	-	percentage (0..100%)	Low
356	Page 1 - Icon 1	Blue dimming value			1 byte	C	-	-	T	-	percentage (0..100%)	Low
358	Page 1 - Icon 1	Switch, status			1 bit	C	-	W	T	U	switch	Low
359	Page 1 - Icon 1	Red brightness, status			1 byte	C	-	W	T	U	percentage (0..100%)	Low
360	Page 1 - Icon 1	Green brightness, status			1 byte	C	-	W	T	U	percentage (0..100%)	Low
361	Page 1 - Icon 1	Blue brightness, status			1 byte	C	-	W	T	U	percentage (0..100%)	Low
363	Page 1 - Icon 1	Warm white brightness			1 byte	C	-	-	T	-	percentage (0..100%)	Low
364	Page 1 - Icon 1	Cool white brightness			1 byte	C	-	-	T	-	percentage (0..100%)	Low
365	Page 1 - Icon 1	Warm white brightness, status			1 byte	C	-	W	T	U	percentage (0..100%)	Low
366	Page 1 - Icon 1	Cool white brightness, status			1 byte	C	-	W	T	U	percentage (0..100%)	Low

RGBCW dimming-Directly(..) &Warm/Cool white brightness

Numbe	Name	Object Function	Descript	Group Ad	Length	C	R	W	T	U	Data Type	Priority
352	Page 1 - Icon 1	Locking object			1 bit	C	-	W	-	-	enable	Low
353	Page 1 - Icon 1	Switch			1 bit	C	-	-	T	-	switch	Low
357	Page 1 - Icon 1	Colour temperature value			2 bytes	C	-	-	T	-	absolute colour temperature (K)	Low
358	Page 1 - Icon 1	Switch, status			1 bit	C	-	W	T	U	switch	Low
362	Page 1 - Icon 1	Colour temperature, status			2 bytes	C	-	W	T	U	absolute colour temperature (K)	Low
363	Page 1 - Icon 1	Brightness value			1 byte	C	-	-	T	-	percentage (0..100%)	Low
365	Page 1 - Icon 1	Brightness, status			1 byte	C	-	W	T	U	percentage (0..100%)	Low

Colour temperature dimming-Normal

Numbe	Name	Object Function	Descript	Group Ad	Length	C	R	W	T	U	Data Type	Priority
352	Page 1 - Icon 1	Locking object			1 bit	C	-	W	-	-	enable	Low
353	Page 1 - Icon 1	Switch			1 bit	C	-	-	T	-	switch	Low
358	Page 1 - Icon 1	Switch, status			1 bit	C	-	W	T	U	switch	Low
362	Page 1 - Icon 1	Colour temperature, status			2 bytes	C	-	W	T	U	absolute colour temperature (K)	Low
363	Page 1 - Icon 1	Warm white brightness			1 byte	C	-	-	T	-	percentage (0..100%)	Low
364	Page 1 - Icon 1	Cool white brightness			1 byte	C	-	-	T	-	percentage (0..100%)	Low
365	Page 1 - Icon 1	Brightness, status			1 byte	C	-	W	T	U	percentage (0..100%)	Low

Colour temperature dimming-Directly(..) &Brightness+Colour Temperature

Numbe	Name	Object Function	Descript	Group Ad	Length	C	R	W	T	U	Data Type	Priority
352	Page 1 - Icon 1	Locking object			1 bit	C	-	W	-	-	enable	Low
353	Page 1 - Icon 1	Switch			1 bit	C	-	-	T	-	switch	Low
358	Page 1 - Icon 1	Switch, status			1 bit	C	-	W	T	U	switch	Low
363	Page 1 - Icon 1	Warm white brightness			1 byte	C	-	-	T	-	percentage (0..100%)	Low
364	Page 1 - Icon 1	Cool white brightness			1 byte	C	-	-	T	-	percentage (0..100%)	Low
365	Page 1 - Icon 1	Warm white brightness, status			1 byte	C	-	W	T	U	percentage (0..100%)	Low
366	Page 1 - Icon 1	Cool white brightness, status			1 byte	C	-	W	T	U	percentage (0..100%)	Low

Colour temperature dimming-Directly(..) &Warm/Cool white brightness

Numbe	Name	Object Function	Descript	Group Ad	Length	C	R	W	T	U	Data Type	Priority
352	Page 1 - Icon 1	Locking object			1 bit	C	-	W	-	-	enable	Low
353	Page 1 - Icon 1	Open/Close			1 bit	C	-	-	T	-	open/close	Low
354	Page 1 - Icon 1	Stop			1 bit	C	-	-	T	-	step	Low

Curtain step/move

Numbe	Name	Object Function	Descript	Group Ad	Length	C	R	W	T	U	Data Type	Priority
352	Page 1 - Icon 1	Locking object			1 bit	C	-	W	-	-	enable	Low
353	Page 1 - Icon 1	Up/Down			1 bit	C	-	-	T	-	up/down	Low
354	Page 1 - Icon 1	Stop			1 bit	C	-	-	T	-	step	Low

Roller blind step/move

Numbe	Name	Object Function	Descript	Group Ad	Length	C	R	W	T	U	Data Type	Priority
352	Page 1 - Icon 1	Locking object			1 bit	C	-	W	-	-	enable	Low
353	Page 1 - Icon 1	Open/Close			1 bit	C	-	-	T	-	open/close	Low
354	Page 1 - Icon 1	Stop			1 bit	C	-	-	T	-	step	Low
355	Page 1 - Icon 1	Curtain position			1 byte	C	-	-	T	-	percentage (0..100%)	Low
358	Page 1 - Icon 1	Curtain position, status			1 byte	C	-	W	T	U	percentage (0..100%)	Low

Curtain position

Numbe	Name	Object Function	Descript	Group Ad	Length	C	R	W	T	U	Data Type	Priority
352	Page 1 - Icon 1	Locking object			1 bit	C	-	W	-	-	enable	Low
353	Page 1 - Icon 1	Up/Down			1 bit	C	-	-	T	-	up/down	Low
354	Page 1 - Icon 1	Stop			1 bit	C	-	-	T	-	step	Low
355	Page 1 - Icon 1	Blind position			1 byte	C	-	-	T	-	percentage (0..100%)	Low
358	Page 1 - Icon 1	Blind position, status			1 byte	C	-	W	T	U	percentage (0..100%)	Low

Roller blind position

Numbe	Name	Object Function	Descript	Group Ad	Length	C	R	W	T	U	Data Type	Priority
352	Page 1 - Icon 1	Locking object			1 bit	C	-	W	-	-	enable	Low
353	Page 1 - Icon 1	Up/Down			1 bit	C	-	-	T	-	up/down	Low
354	Page 1 - Icon 1	Stop/Slat adj.			1 bit	C	-	-	T	-	step	Low
355	Page 1 - Icon 1	Blind position			1 byte	C	-	-	T	-	percentage (0..100%)	Low
356	Page 1 - Icon 1	Slat position			1 byte	C	-	-	T	-	percentage (0..100%)	Low
358	Page 1 - Icon 1	Blind position, status			1 byte	C	-	W	T	U	percentage (0..100%)	Low
359	Page 1 - Icon 1	Slat position, status			1 byte	C	-	W	T	U	percentage (0..100%)	Low

Venetian blind position and slat

Number	Name	Object Function	Description	Group Address	Length	C	R	W	T	U	Data Type	Priority
352	Page 1 - Icon 1	Locking object			1 bit	C	-	W	-	-	enable	Low
353	Page 1 - Icon 1	Send 1bit value			1 bit	C	-	W	T	-	switch	Low
355	Page 1 - Icon 1	Send 1bit value, long			1 bit	C	-	W	T	-	switch	Low
353	Page 1 - Icon 1	Send 2bit value			2 bit	C	-	W	T	-	switch control	Low
355	Page 1 - Icon 1	Send 2bit value, long			2 bit	C	-	W	T	-	switch control	Low
353	Page 1 - Icon 1	Send 4bit value			4 bit	C	-	W	T	-	dimming control	Low
355	Page 1 - Icon 1	Send 4bit value, long			4 bit	C	-	W	T	-	dimming control	Low
353	Page 1 - Icon 1	Send 1byte value			1 byte	C	-	W	T	-	counter pulses (0..255)	Low
355	Page 1 - Icon 1	Send 1byte value, long			1 byte	C	-	W	T	-	counter pulses (0..255)	Low
353	Page 1 - Icon 1	Send 2byte value			2 bytes	C	-	W	T	-	pulses	Low
355	Page 1 - Icon 1	Send 2byte value, long			2 bytes	C	-	W	T	-	pulses	Low

Numbe	Name	Object Function	Descript	Group Ad	Length	C	R	W	T	U	Data Type	Priority
353	Page 1 - Icon 1	Send 2byte float value			2 bytes	C	-	W	T	-	2-byte float value	Low
355	Page 1 - Icon 1	Send 2byte float value, long			2 bytes	C	-	W	T	-	2-byte float value	Low
353	Page 1 - Icon 1	Send 4byte value			4 bytes	C	-	W	T	-	counter pulses (unsigned)	Low
355	Page 1 - Icon 1	Send 4byte value, long			4 bytes	C	-	W	T	-	counter pulses (unsigned)	Low
353	Page 1 - Icon 1	Send 4byte float value			4 bytes	C	-	W	T	-	4-byte float value	Low
355	Page 1 - Icon 1	Send 4byte float value, long			4 bytes	C	-	W	T	-	4-byte float value	Low

Value sender

Numbe	Name	Object Function	Descript	Group Ad	Length	C	R	W	T	U	Data Type	Priority
352	Page 1 - Icon 1	Locking object			1 bit	C	-	W	-	-	enable	Low
353	Page 1 - Icon 1	Scene			1 byte	C	-	-	T	-	scene control	Low
353	Page 1 - Icon 1	Scene			1 byte	C	-	W	T	-	scene control	Low

Scene

Numbe	Name	Object Function	Descript	Group Ad	Length	C	R	W	T	U	Data Type	Priority
353	Page 1 - Icon 1	Status display(2byte temperature)			2 bytes	C	-	W	T	U	temperature (°C)	Low
353	Page 1 - Icon 1	Status display(2byte humidity)			2 bytes	C	-	W	T	U	humidity (%)	Low
353	Page 1 - Icon 1	Status display(1bit)			1 bit	C	-	W	T	U	switch	Low
353	Page 1 - Icon 1	Status display(1byte percentage)			1 byte	C	-	W	T	U	percentage (0..100%)	Low
353	Page 1 - Icon 1	Status display(1byte unsigned)			1 byte	C	-	W	T	U	counter pulses (0..255)	Low
353	Page 1 - Icon 1	Status display(2byte unsigned)			2 bytes	C	-	W	T	U	pulses	Low
353	Page 1 - Icon 1	Status display(2byte lux)			2 bytes	C	-	W	T	U	lux (Lux)	Low
353	Page 1 - Icon 1	Status display(2byte float)			2 bytes	C	-	W	T	U	2-byte float value	Low

Status display

Fig.6.6.1 Basic function communication object

Note: each function should send the status request according to the status feedback object when bus voltage recovery.

NO.	Object Function	Name	Data Type	Flag	DPT
352	Locking object	Page 1 - {{Icon 1}}	1bit	C,W	1.003 enable
<p>The communication object is used to lock/unlock icon function. Except for status display function, apply to the functions as follow. Telegrams:</p> <p style="text-align: center;">0—Lock 1—Unlock</p> <p>The name in parentheses changes with the parameter "Function description (max 10char.)". If description is empty, display "Page x - Icon y" by default. The same below.</p>					
353	Switch	Page 1 - {{Icon 1}}	1bit	C,T	1.001 switch
<p>This communication object apply to switch, press/release switch, relative/brightness dimming, colour and colour temperature control. Only used to switch on and off alternately, no distinction between long and short reaction, and occupy 1 button when link to the mechanical keys. Used for sending On/Off telegrams to the bus, to control the light on/off. Telegrams:</p> <p style="text-align: center;">0—Turn off the light 1—Turn on the light</p>					

358	Switch, status	Page 1 - {{Icon 1}}	1bit	C,W,T,U	1.001 switch
<p>This communication object apply to switch, relative/brightness dimming, colour and colour temperature control. Only used to switch on and off alternately, no distinction between long and short reaction, and occupy 1 button when link to the mechanical keys. Used for receiving On/Off status responded from other bus devices, such as dimming actuator, switch actuator. Telegrams:</p> <p>0—Turn off the light</p> <p>1—Turn on the light</p>					
354	Relative dimming	Page 1 - {{Icon 1}}	4bit	C,T	3.007 dimming
<p>The communication object is used to relative dimming, send the dimming telegram to the bus. Telegrams: 0~100%</p> <p>Short press the icon on the screen to switch on/off; long press to brighter/darker the brightness, release to stop dimming.</p>					
355	Brightness dimming	Page 1 - {{Icon 1}}	1byte	C,T	5.001 percentage(0..100%)
360	Brightness, status	Page 1 - {{Icon 1}}	1byte	C,W,T,U	5.001 percentage(0..100%)
<p>These two communication objects apply to brightness dimming. Telegrams: 0~100%</p> <p>Obj.355: Used for sending dimming telegrams to the bus, that is, sending the brightness value.</p> <p>Obj.360: Used for receiving brightness status responded from dimming actuator.</p> <p>There is no relative dimming button, only link to mechanical keys need to send dimming with 4 bit object "Relative dimming".</p>					
354	RGB dimming value	Page 1 - {{Icon 1}}	3bytes	C,T	232.600 RGB value 3x(0..255)
359	RGB brightness, status	Page 1 - {{Icon 1}}	3bytes	C,W,T,U	232.600 RGB value 3x(0..255)

These two communication objects are visible when 1x3byte for the RGB object type is selected.

Apply to control brightness of multi-colour lamp, and also support colour temperature adjustment.

Obj.354: Used for sending brightness value of RGB three-colour lamp to the bus.

Obj.359: Used for receiving brightness value of RGB three-colour lamp from bus.

3-Byte Code for RGB Dimming Object Data Type: U8 U8 U8, as follows:

3 _{MSB}	2	1 _{LSB}
R	G	B
UUUUUUUU	UUUUUUUU	UUUUUUUU

R: red dimming value; G: green dimming value; B: blue dimming value.

354	RGBW dimming value	Page 1 - {{Icon 1}}	6bytes	C,T	251.600 DPT_Colour_RGBW
359	RGBW brightness, status	Page 1 - {{Icon 1}}	6bytes	C,W,T,U	251.600 DPT_Colour_RGBW

These two communication objects are visible when 1x6byte for the RGBW object type is selected.

Apply to control brightness of multi-colour lamp, and also support colour temperature adjustment.

Obj.354: Used for sending brightness value of RGBW four-colour lamp to the bus.

Obj.359: Used for receiving brightness value of RGBW four-colour lamp from bus.

Encoding of the data type of the 6-byte RGBW dimming object: U8 U8 U8 U8 R8 R4 B4, as follows:

6 _{MSB}	5	4	3	2	1 _{LSB}
R	G	B	W	Reserve	r r r r mR mG mB mW
UUUUUUUU	UUUUUUUU	UUUUUUUU	UUUUUUUU	0000000 0	0000BBBB

R: red dimming value; G: green dimming value; B: blue dimming value; W: white dimming value;







mR: determines whether the red dimming value is valid, 0 = invalid, 1 = valid;

mG: determines whether the green dimming value is valid, 0 = invalid, 1 = valid;

mB: determines whether the blue dimming value is valid, 0 = invalid, 1 = valid;

mW: Determines whether the white dimming value is valid,0 = invalid,1 =valid.

354	Red dimming value	Page 1 - {{Icon 1}}	1byte	C,T	5.001 percentage(0..100%)
359	Red brightness, status	Page 1 - {{Icon 1}}	1byte	C,W,T,U	5.001 percentage(0..100%)

<p>These two communication objects are visible when 3x1byte for the RGB object type or 4x1byte for the RGBW object type is selected. Apply to control brightness of multi-colour lamp, and also support colour temperature adjustment. Telegrams: 0...100%</p> <p>Obj.354: Used for sending brightness value of the control R (red) channel to the bus.</p> <p>Obj.359: Used for receiving brightness value of the control R (red) channel from bus.</p>					
355	Green dimming value	Page 1 - 	1byte	C,T	5.001 percentage(0..100%)
360	Green brightness, status	Page 1 - 	1byte	C,W,T,U	5.001 percentage(0..100%)
<p>These two communication objects are visible when 3x1byte for the RGB object type or 4x1byte for the RGBW object type is selected. Apply to control brightness of multi-colour lamp, and also support colour temperature adjustment. Telegrams: 0...100%</p> <p>Obj.355: Used for sending brightness value of the control G (green) channel to the bus.</p> <p>Obj.360: Used for receiving brightness value of the control G (green) channel from bus.</p>					
356	Blue dimming value	Page 1 - 	1byte	C,T	5.001 percentage(0..100%)
361	Blue brightness, status	Page 1 - 	1byte	C,W,T,U	5.001 percentage(0..100%)
<p>These two communication objects are visible when 3x1byte for the RGB object type or 4x1byte for the RGBW object type is selected. Apply to control brightness of multi-colour lamp, and also support colour temperature adjustment. Telegrams: 0...100%</p> <p>Obj.356: Used for sending brightness value of the control B (blue) channel to the bus.</p> <p>Obj.361: Used for receiving brightness value of the control B (blue) channel from bus.</p>					
357	White dimming value	Page 1 - 	1byte	C,T	5.001 percentage(0..100%)
362	White brightness, status	Page 1 - 	1byte	C,W,T,U	5.001 percentage(0..100%)
<p>These two communication objects are visible when 4x1byte for the RGBW object type is selected. Apply to control brightness of multi-colour lamp, and also support colour temperature adjustment. Telegrams: 0...100%</p> <p>Obj.357: Used for sending brightness value of the control W (white) channel to the bus.</p> <p>Obj.362: Used for receiving brightness value of the control W (white) channel from bus.</p>					
357	Colour temperature value	Page 1 - 	2bytes	C,T	7.600 absolute colour temperature

362	Colour temperature, status	Page 1 - {{Icon 1}}	2bytes	C,W,T,U	7.600 absolute colour temperature
<p>These two communication objects apply to colour temperature adjustment of monochrome lamp/two-colour lamp. Telegrams: 2000...7000 K</p> <p>Obj.357: Under normal control, used for sending the control telegram of the colour temperature to the bus.</p> <p>Obj.362: Under normal or directly control & (Brightness+Colour Temperature), used for receiving the control telegram of the colour temperature from bus.</p>					
363	Brightness value	Page 1 - {{Icon 1}}	1byte	C,T	5.001 percentage(0..100%)
365	Brightness, status	Page 1 - {{Icon 1}}	1byte	C,W,T,U	5.001 percentage(0..100%)
<p>These two communication objects apply to colour temperature adjustment of monochrome lamp/two-colour lamp. Telegrams: 0...100%</p> <p>Obj.363: Under normal control, used for sending the dimming telegram of the colour temperature to the bus, that is, sending the brightness value.</p> <p>Obj.365: Under normal or directly control & (Brightness+Colour Temperature), used for receiving the brightness status responded from the dimming actuator.</p>					
363	Warm white brightness	Page 1 - {{Icon 1}}	1byte	C,T	5.001 percentage(0..100%)
365	Warm white brightness, status	Page 1 - {{Icon 1}}	1byte	C,W,T,U	5.001 percentage(0..100%)
<p>Under the directly control, these two communication objects apply to warm white brightness control of two-colour lamp. Telegrams: 0...100%</p> <p>Obj.363: Under directly control, used for sending the warm white dimming telegram to the bus, that is, sending the warm white brightness value.</p> <p>Obj.365: Under directly control & (Warm/Cool white brightness), used for receiving the warm white brightness status responded from the dimming actuator.</p>					
364	Cool white brightness	Page 1 - {{Icon 1}}	1byte	C,T	5.001 percentage(0..100%)
366	Cool white brightness, status	Page 1 - {{Icon 1}}	1byte	C,W,T,U	5.001 percentage(0..100%)

Under the directly control, these two communication objects apply to cool white brightness control of two-colour lamp. Telegrams: 0...100%

Obj.363: Under directly control, used for sending the cool white dimming telegram to the bus, that is, sending the cool cool brightness value.

Obj.365: Under directly control & (Warm/Cool white brightness), used for receiving the cool white brightness status responded from the dimming actuator.

353	Open/Close	Page 1 - {{Icon 1}}	1bit	C,T	1.009 open/close
354	Stop	Page 1 - {{Icon 1}}	1bit	C,T	1.007 step

Curtain step/move: these two communication objects apply to open and close curtain. Support to open, close, stop.

Obj.353: Used for sending the telegram to the bus, to control curtain open/close. Telegrams:

1—Close the curtain

0—Open the curtain

Obj.354: Used for sending the telegram to the bus, to stop curtain movement. Telegrams:

1—Stop

353	Up/Down	Page 1 - {{Icon 1}}	1bit	C,T	1.008 up/down
354	Stop	Page 1 - {{Icon 1}}	1bit	C,T	1.007 step

Roller blind step/move: these two communication objects apply to roller blind. Support to up, down, stop.

Obj.353: Used for sending the telegram to the bus, to control blind up/down. Telegrams:

1—Move down

0—Move up

Obj.354 is the same as above.

353	Open/Close	Page 1 - {{Icon 1}}	1bit	C,T	1.009 open/close
354	Stop	Page 1 - {{Icon 1}}	1bit	C,T	1.007 step
355	Curtain position	Page 1 - {{Icon 1}}	1byte	C,T	5.001 percentage(0..100%)

358	Curtain position, status	Page 1 - {{Icon 1}}	1byte	C,W,T,U	5.001 percentage(0..100%)
<p>Curtain position: apply to open and close curtain. Support to open, close, stop, position adjustment and position status feedback.</p> <p>Obj.353: Used for sending the telegram to the bus, to control curtain open/close. Telegrams:</p> <p style="padding-left: 40px;">1—Close the curtain</p> <p style="padding-left: 40px;">0—Open the curtain</p> <p>Obj.354: Used for sending the telegram to the bus, to stop curtain movement. Telegrams:</p> <p style="padding-left: 40px;">1—Stop</p> <p>Obj.355: Used for sending a telegram to control the position of the curtain to the bus. Telegrams: 0...100%</p> <p>Obj.358: Used for receiving a curtain position status in response to the window curtain actuator on the bus. Telegrams: 0...100%</p>					
353	Up/Down	Page 1 - {{Icon 1}}	1bit	C,T	1.008 up/down
354	Stop	Page 1 - {{Icon 1}}	1bit	C,T	1.007 step
355	Blind position	Page 1 - {{Icon 1}}	1byte	C,T	5.001 percentage(0..100%)
358	Blind position, status	Page 1 - {{Icon 1}}	1byte	C,W,T,U	5.001 percentage(0..100%)
<p>Roller blind position: apply to a roller blind without slat. Support to up, down, stop, position adjustment and position status feedback.</p> <p>Obj.353: Used for sending the telegram to the bus, to control blind up/down. Telegrams:</p> <p style="padding-left: 40px;">1—Move down</p> <p style="padding-left: 40px;">0—Move up</p> <p>Obj.355: Used for sending a telegram to control the position of the roller blind to the bus. Telegrams: 0...100%</p> <p>Obj.358: Used for receiving a roller blind position status in response to the roller blind actuator on the bus. Telegrams: 0...100%</p> <p>Obj.354 is the same as above.</p>					
353	Up/Down	Page 1 - {{Icon 1}}	1bit	C,T	1.008 up/down

354	Stop/Slat adj.	Page 1 - {{Icon 1}}	1bit	C,T	1.007 step
355	Blind position	Page 1 - {{Icon 1}}	1byte	C,T	5.001 percentage(0..100%)
356	Slat position	Page 1 - {{Icon 1}}	1byte	C,T	5.001 percentage(0..100%)
358	Blind position, status	Page 1 - {{Icon 1}}	1byte	C,W,T,U	5.001 percentage(0..100%)
359	Slat position, status	Page 1 - {{Icon 1}}	1byte	C,W,T,U	5.001 percentage(0..100%)
<p>Venetian blind position and slat: apply to a blind with slat. Support to up, down, stop, position and slat adjustment, position and slat status feedback.</p> <p>Obj.353、 Obj.355 and Obj.358 are same as above.</p> <p>Obj.354: Used for sending a telegram to the bus to stop the curtain movement or adjust the slat angle. Telegrams:</p> <p style="padding-left: 40px;">1—Stop/Slat adj. Down</p> <p style="padding-left: 40px;">0—Stop/Slat adj. Up</p> <p>Obj.356: Used for sending a telegram to control the position of the blind to the bus. Telegrams: 0...100%</p> <p>Obj.359: Used for receiving a blind position status in response to the blind actuator on the bus. Telegrams: 0...100%</p>					
353	Send 1bit value	Page 1 - {{Icon 1}}		C,T,W	1.001 switch
	Send 2bit value		1bit		2.001 switch control
	Send 4bit value		2bit		3.007 dimming
	Send 1byte value		4bit		5.010 counter pulses
	Send 2byte value		1byte		7.001 pulses
	Send 2byte float value		2bytes		9.x float value
	Send 4byte value		4bytes		12.001 counter pulses
	Send 4byte float value			14.x float value	
355	Send 1bit value, long	Page 1 - {{Icon 1}}		C,T,W	1.001 switch
	Send 2bit value, long		1bit		2.001 switch control
	Send 4bit value, long		2bit		3.007 dimming
	Send 1byte value, long		4bit		5.010 counter pulses
	Send 2byte value, long		1byte		7.001 pulses
	Send 2byte float value, long		2bytes		9.x float value
	Send 4byte value, long		4bytes		12.001 counter pulses
	Send 4byte float value, long			14.x float value	

<p>These two communication objects are used for sending a fixed value to the bus. Object type and value range are determined by the parameter setting datatype.</p> <p>Distinguish short and long operation, and configuration independently. Object 353 sends telegram when short operation; object 355 sends telegram when long operation. Only occupy 1 button when link to the mechanical keys.</p>					
353	Scene	Page 1 - {{Icon 1}}	1byte	C,T C,W,T	18.001 scene control
<p>The communication object is used to send the telegram of scene recall or storage. The highest bit 1 is the scene storage, and the highest bit 0 is the scene recall.</p> <p>Short press the icon to recall scene, and long press is optional whether to storage scene.</p> <p>The flag is C,W,T when enable the object with status feedback; the flag is C,T, when disable.</p>					
353	Status display(1bit) Status display(1byte percentage) Status display(1byte unsigned) Status display(2byte unsigned) Status display(2byte temperature) Status display(2byte humidity) Status display(2byte lux) Status display(2byte float)	Page 1 - {{Icon 1}}	1bit 1byte 2bytes	C,W,T,U	1.001 switch 5.001 percentage(0..100%) 5.010 counter pulses 7.001 pulses 9.001 temperature 9.007 humidity 9.004 lux(lux) 9*2byte float value
<p>The communication object is used to receive data of status display, the corresponding value obtained from bus is updated to the screen display. Object type and value range are determined by the parameter setting datatype.</p> <p>Support the data information of 1bit, 1byte percent, 1byte int, 2byte int, 2byte float. For example, 1 bit type links with dynamic description to display the status of the room occupancy, lock, curtain, power and etc.</p> <p>This function can not link to the mechanical keys.</p>					

Table 6.6.1 Basic function communication object table

6.6.2. Communication Object of Air condition

Number	Name	Object Function	Description	Group Ad	Length	C	R	W	T	U	Data Type	Priority
352	Page 1 - Icon 1	Locking object			1 bit	C	-	W	-	-	enable	Low
353	Page 1 - Icon 1	Power on/off			1 bit	C	-	-	T	-	switch	Low
354	Page 1 - Icon 1	Current setpoint adjustment			2 bytes	C	-	-	T	-	temperature (°C)	Low
356	Page 1 - Icon 1	Fan speed			1 byte	C	-	-	T	-	percentage (0..100%)	Low
357	Page 1 - Icon 1	Vanes swing (1-swing,0-stop)			1 bit	C	-	-	T	-	start/stop	Low
359	Page 1 - Icon 1	Control mode			1 byte	C	-	-	T	-	HVAC control mode	Low
360	Page 1 - Icon 1	Power on/off, status			1 bit	C	-	W	T	U	switch	Low
361	Page 1 - Icon 1	External temperature sensor			2 bytes	C	-	W	T	U	temperature (°C)	Low
362	Page 1 - Icon 1	Current temperature setpoint, status			2 bytes	C	-	W	T	U	temperature (°C)	Low
363	Page 1 - Icon 1	Fan speed, status			1 byte	C	-	W	T	U	percentage (0..100%)	Low
364	Page 1 - Icon 1	Vanes swing (1-swing,0-stop), status			1 bit	C	-	W	T	U	switch	Low
366	Page 1 - Icon 1	Control mode, status			1 byte	C	-	W	T	U	HVAC control mode	Low
367	Page 1 - Icon 1	Timer			1 bit	C	-	W	-	-	enable	Low
368	Page 1 - Icon 1	Scene			1 byte	C	-	W	-	-	scene control	Low

Fig.6.6.2 Air condition function communication object

NO.	Object Function	Name	Data Type	Flag	DPT
352	Locking object	Page 1 - {{Icon 1}}	1bit	C,W	1.003 enable
<p>The communication object is used to lock/unlock air condition function. Telegrams:</p> <p>0—Lock</p> <p>1—Unlock</p>					
353	Power on/off	Page 1 - {{Icon 1}}	1bit	C,T	1.001 switch
<p>The communication object is used to send the power on/off telegram of air condition, to control air condition power on/off on the KNX bus.</p> <p>The system needs to return to the status before voltage failure when voltage recovery, and send status request of function point: power on/off, mode, fan speed, setpoint temperature, external temperature sensor, vanes swing.</p>					
354	Current setpoint adjustment	Page 1 - {{Icon 1}}	1byte 2bytes	C,T	5.010 counter pulses 9.001 temperature
<p>The communication object is used to adjust setpoint temperature via the bus, and send telegram value to the bus.</p>					
356	Fan speed	Page 1 - {{Icon 1}}	1byte	C,T	5.001 percentage 5.100 fan stage
<p>The communication object is used to send control telegram of each fan speed to the bus. Telegram value is determined by parameter setting datatype.</p>					
357	Vanes swing (1-swing,0-stop)	Page 1 - {{Icon 1}}	1bit	C,T	1.010 start/stop

<p>The communication object is visible when swing function enabled. Used to send telegram controlling vanes swing to the bus. Telegrams:</p> <p style="text-align: center;">1—Swing</p> <p style="text-align: center;">0—Stop</p>					
359	Control mode	Page 1 - {{Icon 1}}	1byte	C,T	20.105 HVAC control mode
<p>The communication object is used to send control telegram of each air condition mode to the bus. Different telegram means different control mode.</p> <p>0-Auto, 1- Heating, 3-Cooling, 9-Fan, 14-Dehumidity, other reserved.</p>					
360	Power on/off, status	Page 1 - {{Icon 1}}	1bit	C,W,T,U	1.001 switch
<p>The communication object is used to receive the power on/off telegram of air condition from the bus, and feedback to screen display. Telegrams:</p> <p style="text-align: center;">1—On</p> <p style="text-align: center;">0—Off</p>					
361	External temperature sensor	Page 1 - {{Icon 1}}	2byte s	C,W,T,U	9.001 temperature
<p>The communication object is used to receive the room temperature from the bus, and send read request cyclically, and feedback to screen display.</p>					
362	Current temperature setpoint, status	Page 1 - {{Icon 1}}	1byte 2byte s	C,W,T,U	5.010 counter pulses 9.001 temperature
<p>The communication object is used to receive the current setpoint temperature from the bus, and feedback to screen display.</p>					
363	Fan speed, status	Page 1 - {{Icon 1}}	1byte	C,W,T,U	5.001 percentage 5.100 fan stage
<p>The communication object is used to receive the current fan speed from the bus, and feedback to screen display. Telegram value is determined by parameter setting datatype.</p>					

364	Vanes swing (1-swing,0-stop), status	Page 1 - {{Icon 1}}	1bit	C,W,T,U	1.010 start/stop
<p>The communication object is visible when swing function enabled. Used to receive vanes swing status from the bus. Telegrams:</p> <p style="padding-left: 40px;">1—Swing</p> <p style="padding-left: 40px;">0—Stop</p>					
366	Control mode, status	Page 1 - {{Icon 1}}	1byte	C,W,T,U	20.105 HVAC control mode
<p>The communication object is used to receive the current control mode from the bus, and feedback to screen display. Different telegram means different control mode.</p> <p style="padding-left: 40px;">0-Auto, 1- Heating, 3-Cooling, 9-Fan, 14-Dehumidity, other reserved.</p>					
367	Timer	Page 1 - {{Icon 1}}	1bit	C,W	1.003 enable
<p>The communication object is visible when timer function enabled. Used to turn on/off the timing via the bus.</p>					
368	Scene	Page 1 - {{Icon 1}}	1byte	C,W	18.001 scene control
<p>The communication object is visible when scene function enabled. Used to recall/storage scene via bus.</p>					

Table 6.6.2 Air condition function communication object table







6.6.3. Communication Object of Room temperature unit

Numbe	Name	Object Function	Descript	Group Ad	Length	C	R	W	T	U	Data Type	Priority
352	Page 1 - Icon 1	Locking object			1 bit	C	-	W	-	-	enable	Low
353	Page 1 - Icon 1	Power on/off			1 bit	C	-	-	T	-	switch	Low
354	Page 1 - Icon 1	Current setpoint adjustment			2 bytes	C	-	-	T	-	temperature (°C)	Low
355	Page 1 - Icon 1	Current setpoint adjustment(1bit)			1 bit	C	-	-	T	-	step	Low
356	Page 1 - Icon 1	Fan speed			1 byte	C	-	-	T	-	percentage (0..100%)	Low
357	Page 1 - Icon 1	Fan automatic operation			1 bit	C	-	-	T	-	enable	Low
358	Page 1 - Icon 1	Heating/Cooling mode			1 bit	C	-	-	T	-	cooling/heating	Low
359	Page 1 - Icon 1	Operation mode			1 byte	C	-	-	T	-	HVAC mode	Low
360	Page 1 - Icon 1	Power on/off, status			1 bit	C	-	W	-	-	switch	Low
361	Page 1 - Icon 1	External temperature sensor			2 bytes	C	-	W	T	U	temperature (°C)	Low
362	Page 1 - Icon 1	Current temperature setpoint, status			2 bytes	C	-	W	T	U	temperature (°C)	Low
363	Page 1 - Icon 1	Fan speed, status			1 byte	C	-	W	T	U	percentage (0..100%)	Low
364	Page 1 - Icon 1	Fan automatic operation, status			1 bit	C	-	W	T	U	enable	Low
365	Page 1 - Icon 1	Heating/Cooling mode, status			1 bit	C	-	W	T	U	cooling/heating	Low
366	Page 1 - Icon 1	Operation mode, status			1 byte	C	-	W	T	U	HVAC mode	Low
367	Page 1 - Icon 1	Timer			1 bit	C	-	W	-	-	enable	Low
368	Page 1 - Icon 1	Scene			1 byte	C	-	W	-	-	scene control	Low

Fig.6.6.3 Room temperature unit function communication object

NO.	Object Function	Name	Data Type	Flag	DPT
352	Locking object	Page 1 - {{Icon 1}}	1bit	C,W	1.003 enable
<p>The communication object is used to lock/unlock RTC function. Telegrams:</p> <p>0—Lock</p> <p>1—Unlock</p>					
353	Power on/off	Page 1 - {{Icon 1}}	1bit	C,T	1.001 switch
<p>The communication object is used to send the power on/off telegram of RTC, to control RTC power on/off on the KNX bus.</p> <p>The system needs to return to the status before voltage failure when voltage recovery, and send status request of function point: control mode, operation mode, fan speed, setpoint temperature, external temperature sensor.</p>					
354	Current setpoint adjustment	Page 1 - {{Icon 1}}	2bytes	C,T	9.001 temperature
<p>The communication object is visible when object datatype of setpoint temperature adjustment is 2 byte or 1 bit & timer function enabled. Through the screen to adjust setpoint temperature, 2 byte object relatively adjusts the setpoint temperature value, and sent telegram value to the bus.</p>					

355	Current setpoint adjustment(1bit)	Page 1 - {{Icon 1}}	1bit	C,T	1.007 step
<p>The communication object is visible when object datatype of setpoint temperature adjustment is 1 bit. Through the screen to adjust setpoint temperature, 1 bit object relatively adjusts, and sent telegram value to the bus.</p>					
356	Fan speed	Page 1 - {{Icon 1}}	1byte	C,T	5.001 percentage 5.100 fan stage
<p>The communication object is used to send control telegram of each fan speed to the bus. Telegram value is determined by parameter setting datatype.</p>					
357	Fan automatic operation	Page 1 - {{Icon 1}}	1bit	C,T	1.003 enable
<p>The communication object is used to send control telegram of fan automatic operation to the bus. Telegrams:</p> <p style="padding-left: 40px;">1—Automatic 0—Cancel automatic</p>					
358	Heating/Cooling mode	Page 1 - {{Icon 1}}	1bit	C,T	1.100 cooling/heating
<p>The communication object is used to send telegram for switching cooling and heating functions to the bus. Telegrams:</p> <p style="padding-left: 40px;">1—Heating 0—Cooling</p>					
359	Operation mode	Page 1 - {{Icon 1}}	1byte	C,T	20.102 HVAC mode
<p>The communication object is used to send the telegram of the room operation mode to the bus. Different telegram means different control mode:</p> <p style="padding-left: 40px;">1-Comfort, 2-Standby, 3-Economy, 4-Protection, other reserved.</p>					
360	Power on/off, status	Page 1 - {{Icon 1}}	1bit	C,W	1.001 switch
<p>The communication object is used to receive the power on/off telegram of RTC from the bus, and feedback to screen display. Telegrams:</p> <p style="padding-left: 40px;">1—On 0—Off</p>					

361	External temperature sensor	Page 1 - 	2bytes	C,W,T,U	9.001 temperature
The communication object is used to receive the room temperature from the bus, and send read request cyclically, and feedback to screen display.					
362	Current temperature setpoint, status	Page 1 - 	2bytes	C,W,T,U	9.001 temperature
The communication object is used to receive the current setpoint temperature from the bus, and feedback to screen display.					
363	Fan speed, status	Page 1 - 	1byte	C,W,T,U	5.001 percentage 5.100 fan stage
The communication object is used to receive the current fan speed from the bus, and feedback to screen display. Telegram value is determined by parameter setting datatype.					
364	Fan automatic operation, status	Page 1 - 	1bit	C,W,T,U	1.003 enable
The communication object is used to receive feedback status of fan automatic operation from the bus. Telegrams: 1—Automatic 0—Cancel automatic					
365	Heating/Cooling mode, status	Page 1 - 	1bit	C,W,T,U	1.100 cooling/heating
The communication object is used to receive the heating and cooling status from the bus, and feedback to screen display. Telegrams: 1 —Heating 0 —Cooling					
366	Operation mode, status	Page 1 - 	1byte	C,W,T,U	20.102 HVAC mode
The communication object is used to receive the telegram of RTC operation mode from the bus. Different telegram means different control mode: 1-Comfort, 2-Standby, 3-Economy, 4-Protection, other reserved.					

367	Timer	Page 1 - {{Icon 1}}	1bit	C,W	1.003 enable
The communication object is visible when timer function enabled. Used to turn on/off the timing via the bus.					
368	Scene	Page 1 - {{Icon 1}}	1byte	C,W	18.001 scene control
The communication object is visible when scene function enabled. Used to recall/storage scene via bus.					

Table 6.6.3 Room temperature unit function communication object table

6.6.4. Communication Object of Ventilation system

Number	Name	Object Function	Descriptor	Group Ad	Length	C	R	W	T	U	Data Type	Priority
352	Page 1 - Icon 1	Locking object			1 bit	C	-	W	-	-	enable	Low
353	Page 1 - Icon 1	Power on/off			1 bit	C	-	-	T	-	switch	Low
354	Page 1 - Icon 1	Filter timer counter			2 bytes	C	-	-	T	-	time (h)	Low
355	Page 1 - Icon 1	Filter alarm			1 bit	C	-	-	T	-	alarm	Low
356	Page 1 - Icon 1	Fan speed			1 byte	C	-	-	T	-	percentage (0..100%)	Low
357	Page 1 - Icon 1	Fan automatic operation			1 bit	C	-	-	T	-	enable	Low
358	Page 1 - Icon 1	Heat recovery			1 bit	C	-	-	T	-	enable	Low
360	Page 1 - Icon 1	Power on/off, status			1 bit	C	-	W	-	-	switch	Low
361	Page 1 - Icon 1	Filter timer counter change			2 bytes	C	-	W	-	-	time (h)	Low
363	Page 1 - Icon 1	Fan speed, status			1 byte	C	-	W	-	-	percentage (0..100%)	Low
364	Page 1 - Icon 1	Fan automatic operation, status			1 bit	C	-	W	-	-	enable	Low
365	Page 1 - Icon 1	Heat recovery, status			1 bit	C	-	W	-	-	enable	Low
367	Page 1 - Icon 1	Filter timer reset			1 bit	C	-	W	-	-	reset	Low
368	Page 1 - Icon 1	Scene			1 byte	C	-	W	-	-	scene control	Low

Fig.6.6.4 Ventilation system function communication object

NO.	Object Function	Name	Data Type	Flag	DPT
352	Locking object	Page 1 - {{Icon 1}}	1bit	C,W	1.003 enable
The communication object is used to lock/unlock ventilation system function. Telegrams:					
0—Lock					
1—Unlock					

353	Power on/off	Page 1 - {{Icon 1}}	1bit	C,T	1.001 switch
<p>The communication object is used to send the power on/off telegram of ventilation, to control ventilation power on/off on the KNX bus. Cancel Auto function at the same time after power-off.</p>					
354	Filter timer counter	Page 1 - {{Icon 1}}	2bytes	C,T	7.007 time(h)
<p>The communication object is used to count the length of the filter, send telegram to the bus when the count value changes. The unit of filter time counter is in hours.</p>					
355	Filter alarm	Page 1 - {{Icon 1}}	1bit	C,T	1.005 alarm
<p>When the filter is used for longer than the set value, the communication object sends an alarm to remind the user to replace the filter. Telegram value:</p> <p style="text-align: center;">1—Alarm</p>					
356	Fan speed	Page 1 - {{Icon 1}}	1byte	C,T	5.001 percentage 5.100 fan stage
<p>The communication object is used to control fan speed via the screen, and send control telegram of each fan speed to the bus. Telegram value is determined by parameter setting datatype.</p>					

357	Fan automatic operation	Page 1 - {{Icon 1}}	1bit	C,T	1.003 enable
<p>The communication object is used to activate fan automatic operation via the screen, and send control telegram of fan automatic operation to the bus. Telegrams:</p> <p style="text-align: center;">1—Automatic</p> <p style="text-align: center;">0—Cancel automatic</p>					
358	Heat recovery	Page 1 - {{Icon 1}}	1bit	C,T	1.003 enable
<p>The communication object is used to control heat recovery mode via the screen, and send telegram to the bus. Telegrams:</p> <p style="text-align: center;">1—Active</p> <p style="text-align: center;">0—Inactive</p>					

360	Power on/off, status	Page 1 - {{Icon 1}}	1bit	C,W	1.001 switch
<p>The communication object is used to receive the power on/off telegram of ventilation from the bus, and feedback to screen display. Telegrams:</p> <p>1—On</p> <p>0—Off</p>					
361	Filter timer counter change	Page 1 - {{Icon 1}}	2bytes	C,W	7.007 time(h)
<p>The communication object is used to modify the time length of the filter usage by the bus, the unit is in hours.</p>					
363	Fan speed, status	Page 1 - {{Icon 1}}	1byte	C,W	5.001 percentage 5.100 fan stage
<p>The communication object is used to receive the current fan speed from the bus, and feedback to screen display. Telegram value is determined by parameter setting datatype.</p>					
364	Fan automatic operation, status	Page 1 - {{Icon 1}}	1bit	C,W	1.003 enable
<p>The communication object is used to receive feedback status of fan automatic operation from the bus, and feedback to screen display. Telegrams:</p> <p>1—Automatic</p> <p>0—Cancel automatic</p>					
365	Heat recovery, status	Page 1 - {{Icon 1}}	1bit	C,W	1.003 enable
<p>The communication object is used to receive status of heat recovery mode, and feedback the heat recovery mode status to screen display. Telegrams:</p> <p>1—Active</p> <p>0—Inactive</p>					
367	Filter timer reset	Page 1 - {{Icon 1}}	1bit	C,W	1.015 reset
<p>The communication object is used to reset the filter time, and after the filter is reset, the filter time is used to start counting again. Telegram value:</p> <p>1—Reset</p>					
368	Scene	Page 1 - {{Icon 1}}	1byte	C,W	18.001 scene control
<p>The communication object is visible when scene function enabled. Used to recall/storage scene via bus.</p>					

Table 6.6.4 Ventilation system function communication object table

6.6.5. Communication Object of Audio control

Number	Name	Object Function	Description	Group Address	Length	C	R	W	T	U	Data Type	Priority
352	Page 1 - Icon 1	Locking object			1 bit	C	-	W	-	-	enable	Low
353	Page 1 - Icon 1	Power on/off			1 bit	C	-	-	T	-	switch	Low
354	Page 1 - Icon 1	Play=1/Pause=0			1 bit	C	-	-	T	-	start/stop	Low
355	Page 1 - Icon 1	Next track=1/Previous track=0			1 bit	C	-	-	T	-	step	Low
356	Page 1 - Icon 1	Absolute volume			1 byte	C	-	-	T	-	percentage (0..100%)	Low
359	Page 1 - Icon 1	Play mode			1 byte	C	-	-	T	-	counter pulses (0..255)	Low
360	Page 1 - Icon 1	Power on/off, status			1 bit	C	-	W	-	-	switch	Low
361	Page 1 - Icon 1	Play=1/Pause=0, status			1 bit	C	-	W	T	U	start/stop	Low
363	Page 1 - Icon 1	Volume, status			1 byte	C	-	W	T	U	percentage (0..100%)	Low
364	Page 1 - Icon 1	Mute, status			1 bit	C	-	W	T	U	enable	Low
365	Page 1 - Icon 1	Play mode, status			1 byte	C	-	W	T	U	counter pulses (0..255)	Low
366	Page 1 - Icon 1	Track name			14 bytes	C	-	W	T	U	Character String (ISO 8859-1)	Low
367	Page 1 - Icon 1	Album name			14 bytes	C	-	W	T	U	Character String (ISO 8859-1)	Low
368	Page 1 - Icon 1	Artist name			14 bytes	C	-	W	T	U	Character String (ISO 8859-1)	Low
354	Page 1 - Icon 1	Play			1 bit	C	-	-	T	-	enable	Low
358	Page 1 - Icon 1	Pause			1 bit	C	-	-	T	-	enable	Low
361	Page 1 - Icon 1	Play, status			1 bit	C	-	W	T	U	enable	Low
362	Page 1 - Icon 1	Pause, status			1 bit	C	-	W	T	U	enable	Low

Fig.6.6.5 Audio control function communication object

NO.	Object Function	Name	Data Type	Flag	DPT
352	Locking object	Page 1 - {{Icon 1}}	1bit	C,W	1.003 enable
<p>The communication object is used to lock/unlock audio control function. Telegrams:</p> <p>0—Lock</p> <p>1—Unlock</p>					
353	Power on/off	Page 1 - {{Icon 1}}	1bit	C,T	1.001 switch
<p>The communication object is used to control the audio power on/off via the screen, and send the telegram to the bus. Telegrams:</p> <p>1—On</p> <p>0—Off</p> <p>When function of power on/off is inactive, the system needs to return to the status before voltage failure when voltage recovery, and send status request of function point: play status, mute, volume percent, play mode, track name and album name.</p> <p>When function of power on/off is active, no need to send request status telegrams, and default as power off when power start and voltage recovery after finish the download.</p>					
354	Play=1/Pause=0	Page 1 - {{Icon 1}}	1bit	C,T	1.010 start/stop
354	Play	Page 1 - {{Icon 1}}	1bit	C,T	1.003 enable

358	Pause	Page 1 - {{Icon 1}}	1bit	C,T	1.003 enable
<p>These communication objects are used to play/stop the music in the audio module via the screen. When control with one object, telegrams:</p> <p>1—Play music 0—Pause playing music</p> <p>When control with two separate objects, valid telegram values are both 1.</p>					
355	Next track=1/Previous track=0	Page 1 - {{Icon 1}}	1bit	C,T	1.007 step
<p>The communication object is used to switch the playing song of the audio module via the screen, to switch the previous song/the next song. Telegrams:</p> <p>1—Play the next song 0—Play the previous song</p>					
356	Volume+=1/Volume-=0	Page 1 - {{Icon 1}}	1bit	C,T	1.007 step
356	Absolute volume	Page 1 - {{Icon 1}}	1byte	C,T	5.001 percentage 5.004 percentage
<p>The communication object is used to adjust volume of the audio module via the screen. Telegram value is determined by different object datatype.</p> <p>1 bit object, telegrams:</p> <p>1—Increase volume 0—Decrease volume</p>					
<p>1 byte, telegrams value is according to object type: 0..100 / 0..255</p>					
357	Mute	Page 1 - {{Icon 1}}	1bit	C,T	1.003 enable
<p>The communication object is used to control mute of the audio module via the screen. Telegrams:</p> <p>1—Mute 0—Cancel mute</p>					
359	Play mode	Page 1 - {{Icon 1}}	1byte	C,T	5.010 counter pulses
<p>The communication object is used to send control telegram of the audio module play mode, different mode telegrams are preset by parameters.</p>					

360	Power on/off, status	Page 1 - {{Icon 1}}	1bit	C,W	1.001 switch
<p>The communication object is used to receive the power on/off telegram of the audio module from the bus, and feedback to screen display. Telegrams:</p> <p>1—On</p> <p>0—Off</p>					
361	Play=1/Pause=0, status	Page 1 - {{Icon 1}}	1bit	C,W,T,U	1.010 start/stop
361	Play, status	Page 1 - {{Icon 1}}	1bit	C,W,T,U	1.003 enable
362	Pause, status	Page 1 - {{Icon 1}}	1bit	C,W,T,U	1.003 enable
<p>These communication objects are used to receive the music play/stop status from the bus, and feedback to screen display.</p> <p>When control with one object, telegrams:</p> <p>1—Play music</p> <p>0—Pause playing music</p> <p>When control with two separate objects, valid telegram values are both 1.</p>					
363	Volume, status	Page 1 - {{Icon 1}}	1byte	C,W,T,U	5.001 percentage 5.004 percentage
<p>The communication object only applies to 1byte audio control, receive the volume status of the audio, and feedback to screen display. Telegram value is according to object type: 0..100 / 0..255</p>					
364	Mute, status	Page 1 - {{Icon 1}}	1bit	C,W,T,U	1.003 enable
<p>The communication object is used to receive the mute status of the audio module from the bus, and feedback to screen display.</p>					

365	Play mode, status	Page 1 - {{Icon 1}}	1byte	C,W,T,U	5.010 counter pulses
The communication object is used to receive the play mode status of the audio module from the bus, and feedback to screen display. Different mode telegrams are preset by parameters.					
366	Track name	Page 1 - {{Icon 1}}	14bytes	C,W,T,U	16.001 character string (ISO 8859-1)
The communication object is used to modify the track name via the bus, and display on the screen.					
367	Album name	Page 1 - {{Icon 1}}	14bytes	C,W,T,U	16.001 character string (ISO 8859-1)
The communication object is used to modify the album name via the bus, and display on the screen.					
368	Artist name	Page 1 - {{Icon 1}}	14bytes	C,W,T,U	16.001 character string (ISO 8859-1)
The communication object is used to modify the artist name via the bus, and display on the screen.					

Table 6.6.5 Audio control function communication object table

6.7. "Button" Communication Object

Numbe	Name	Object Function	Descript	Group Ad	Length	C	R	W	T	U	Data Type	Priority
964	Btn 1 - Switching	Switch			1 bit	C	-	W	T	U	switch	Low
964	Btn 1 - Switching	Press, Switch			1 bit	C	-	W	T	U	switch	Low
965	Btn 1 - Switching	Release, Switch			1 bit	C	-	W	T	U	switch	Low
964	Btn 1 - Switching	Short, Switch			1 bit	C	-	W	T	U	switch	Low
965	Btn 1 - Switching	Long, Switch			1 bit	C	-	W	T	U	switch	Low
968	Btn 1 - Switching	Disable			1 bit	C	-	W	-	-	enable	Low
969	Btn 1 - Switching	LED status			1 bit	C	-	W	T	U	switch	Low
Switching												
Numbe	Name	Object Function	Descript	Group Ad	Length	C	R	W	T	U	Data Type	Priority
964	Btn 1 - Dimming	Short, Switch			1 bit	C	-	W	T	U	switch	Low
965	Btn 1 - Dimming	Long, Dimming			4 bit	C	-	W	T	-	dimming control	Low
968	Btn 1 - Dimming	Disable			1 bit	C	-	W	-	-	enable	Low
969	Btn 1 - Dimming	LED status			1 bit	C	-	W	T	U	switch	Low
Dimming												
Numbe	Name	Object Function	Descript	Group Ad	Length	C	R	W	T	U	Data Type	Priority
964	Btn 1 - Value sender	Short, 1bit value			1 bit	C	-	-	T	-	switch	Low
965	Btn 1 - Value sender	Long, 1bit value			1 bit	C	-	-	T	-	switch	Low

964	Btn 1 - Value sender	Short, 2bit value	2 bit	C - - T -	switch control	Low
965	Btn 1 - Value sender	Long, 2bit value	2 bit	C - - T -	switch control	Low
964	Btn 1 - Value sender	Short, 4bit value	4 bit	C - - T -	dimming control	Low
965	Btn 1 - Value sender	Long, 4bit value	4 bit	C - - T -	dimming control	Low
964	Btn 1 - Value sender	Short, 1byte value	1 byte	C - - T -	counter pulses (0..255)	Low
965	Btn 1 - Value sender	Long, 1byte value	1 byte	C - - T -	counter pulses (0..255)	Low
964	Btn 1 - Value sender	Short, 2byte value	2 bytes	C - - T -	pulses	Low
965	Btn 1 - Value sender	Long, 2byte value	2 bytes	C - - T -	pulses	Low
968	Btn 1 - Value sender	Disable	1 bit	C - W - -	enable	Low
969	Btn 1 - Value sender	LED status	1 bit	C - W T U	switch	Low

Value sender

Numbe	Name	Object Function	Descript	Group Ad	Length	C	R	W	T	U	Data Type	Priority
964	Btn 1 - Scene	Scene			1 byte	C	-	-	T	-	scene control	Low
964	Btn 1 - Scene	Short, Scene			1 byte	C	-	-	T	-	scene control	Low
965	Btn 1 - Scene	Long, Scene			1 byte	C	-	-	T	-	scene control	Low
968	Btn 1 - Scene	Disable			1 bit	C	-	W	-	-	enable	Low
969	Btn 1 - Scene	LED status			1 bit	C	-	W	T	U	switch	Low

Scene

Number	Name	Object Function	Description	Group Address	Length	C	R	W	T	U	Data Type	Priority
964	Btn 1 - Blind	Up/Down, Blind			1 bit	C	-	W	T	-	up/down	Low
965	Btn 1 - Blind	Stop/Adjust, Blind			1 bit	C	-	W	T	-	step	Low
968	Btn 1 - Blind	Disable			1 bit	C	-	W	-	-	enable	Low
969	Btn 1 - Blind	LED status			1 bit	C	-	W	T	U	switch	Low

Blind

Number	Name	Object Function	Description	Group Address	Length	C	R	W	T	U	Data Type	Priority
964	Btn 1 - Shift register	Register value			1 byte	C	-	W	T	-	counter pulses (0..255)	Low
968	Btn 1 - Shift register	Disable			1 bit	C	-	W	-	-	enable	Low
969	Btn 1 - Shift register	LED status			1 bit	C	-	W	T	U	switch	Low

Shift register

Numbe	Name	Object Function	Descript	Group Ad	Length	C	R	W	T	U	Data Type	Priority
964	Btn 1 - Multiple operation	Object1-On/Off			1 bit	C	-	W	T	-	switch	Low
964	Btn 1 - Multiple operation	Object1-Up/Down			1 bit	C	-	W	T	-	up/down	Low
964	Btn 1 - Multiple operation	Object1-SceneControl			1 byte	C	-	-	T	-	scene control	Low
964	Btn 1 - Multiple operation	Object1-Percentage			1 byte	C	-	-	T	-	percentage (0..100%)	Low
964	Btn 1 - Multiple operation	Object1-Unsigned value			1 byte	C	-	-	T	-	counter pulses (0..255)	Low
968	Btn 1 - Multiple operation	Disable			1 bit	C	-	W	-	-	enable	Low
969	Btn 1 - Multiple operation	LED status			1 bit	C	-	W	T	U	switch	Low

Multiple operation

Numbe	Name	Object Function	Descript	Group Ad	Length	C	R	W	T	U	Data Type	Priority
964	Btn 1 - Delay mode	Short, Delay mode			1 bit	C	-	-	T	-	switch	Low
965	Btn 1 - Delay mode	Long, Delay mode			1 bit	C	-	-	T	-	switch	Low
964	Btn 1 - Delay mode	Short, Delay mode			4 bit	C	-	-	T	-	dimming control	Low
965	Btn 1 - Delay mode	Long, Delay mode			4 bit	C	-	-	T	-	dimming control	Low
964	Btn 1 - Delay mode	Short, Delay mode			1 byte	C	-	-	T	-	counter pulses (0..255)	Low
965	Btn 1 - Delay mode	Long, Delay mode			1 byte	C	-	-	T	-	counter pulses (0..255)	Low
968	Btn 1 - Delay mode	Disable			1 bit	C	-	W	-	-	enable	Low
969	Btn 1 - Delay mode	LED status			1 bit	C	-	W	T	U	switch	Low

Delay mode

Numbe	Name	Object Function	Descript	Group Ad	Length	C	R	W	T	U	Data Type	Priority
964	Btn 1 - RTC mode	Operation mode			1 byte	C	-	-	T	-	HVAC mode	Low
964	Btn 1 - RTC mode	Comfort mode			1 bit	C	-	-	T	-	enable	Low
965	Btn 1 - RTC mode	Economy mode			1 bit	C	-	-	T	-	enable	Low
966	Btn 1 - RTC mode	Frost/Heat protection mode			1 bit	C	-	-	T	-	enable	Low
967	Btn 1 - RTC mode	Standby mode			1 bit	C	-	-	T	-	enable	Low
968	Btn 1 - RTC mode	Disable			1 bit	C	-	W	-	-	enable	Low
969	Btn 1 - RTC mode	LED status			1 bit	C	-	W	T	U	switch	Low

RTC operation mode

Numbe	Name	Object Function	Descript	Group Ad	Length	C	R	W	T	U	Data Type	Priority
964	Btn 1 - String	String			14 bytes	C	-	-	T	-	Character String (ISO 8859-1)	Low
968	Btn 1 - String	Disable			1 bit	C	-	W	-	-	enable	Low
969	Btn 1 - String	LED status			1 bit	C	-	W	T	U	switch	Low

String(14bytes)

Fig.6.7 "Button" communication object

NO.	Object Function	Name	Data Type	Flag	DPT
964	Switch	Btn 1 - {{Switching}}	1bit	C,W,T,U	1.001 switch
964	Press/Short, Switch	Btn 1 - {{Switching}}	1bit	C,W,T,U	1.001 switch
965	Release/Long, Switch	Btn 1 - {{Switching}}	1bit	C,W,T,U	1.001 switch

These communication objects are used to trigger a switching operation. Use a common object or two separate objects is according to the parameter setting when press/release and long/short operation.

Only the object "Switch" is visible when use a common object. If use two separate objects, "Press/Release" is visible when there is no distinction for short/long operation; "Short/Long" is visible when there is distinction for short/long operation. Telegrams:

0—Off

1—On

The name in parentheses changes with the parameter "Description (max 30char.)". If description is empty, display "Btn 1 - ..." by default. The same below.

964	Short, Switch	Btn 1 - {{Dimming}}	1bit	C,W,T,U	1.001 switch
965	Long, Dimming	Btn 1 - {{Dimming}}	4bit	C,W,T	3.007 dimming

These two communication objects are used to switch/dimming operation, with distinction for long/short operation.

Obj.964: Used to trigger switch operation. Telegrams:

0—Off

1—On

Obj.965: Used to trigger a relative dimming operation.

Dimming down when telegram is 1~7, and the larger this range the adjust step is smaller. That is, the maximum step of dimming down when is 1, and the minimum step of dimming down when is 7, stop dimming when is 0;

Dimming up when telegram is 9~15, and the larger this range the adjust step is smaller. That is, the maximum step of dimming up when is 9, and the minimum step of dimming up when is 15, stop dimming when is 8.

964	Short, 1bit value	Btn 1 - {{Value sender}}	1bit	C,T	1.001 switch
	Short, 2bit value		2bit		2.001 switch control
	Short, 4bit value		4bit		3.007 dimming
	Short, 1byte value		1byte		5.010 counter pulses
	Short, 2byte value		2bytes		7.001 pulses
965	Long, 1bit value	Btn 1 - {{Value sender}}	1bit	C,T	1.001 switch
	Long, 2bit value		2bit		2.001 switch control
	Long, 4bit value		4bit		3.007 dimming
	Long, 1byte value		1byte		5.010 counter pulses
	Long, 2byte value		2bytes		7.001 pulses

These two communication objects are used for sending a fixed value to the bus, distinguish long and short operation. Range of values that can be sent are determined by the datatype, and the datatype is determined by the parameter setting.

964	Scene	Btn 1 - {{Scene}}	1byte	C,T	18.001 scene control
964	Short, Scene	Btn 1 - {{Scene}}	1byte	C,T	18.001 scene control
965	Long, Scene	Btn 1 - {{Scene}}	1byte	C,T	18.001 scene control

These communication objects are used to send a 8 bit command to recall or storage scene. Use a common object or two separate objects is according to the parameter setting when long and short operation.

Only the object "Scene" is visible when use a common object. If use two separate objects, "Short/Long" is visible when there is distinction for short/long operation. Telegrams:

Detailed 8bit the meaning of the directive.

Set up a 8bit Orders for the (Binary code): FXNNNNNN

F: '0' recall scene; '1' for storage scene;

X : 0 ;

NNNNNN: Scene number(0... 63).

As follows:

Object message value	Description
0	Recall scene 1
1	Recall scene 2
2	Recall scene 3
...	...
63	Recall scene 64
128	Store scene 1
129	Store scene 2
130	Store scene 3
...	...
191	Store scene 64

Parameter setting Options are 1~64, actually communication object "Scene" corresponds to the telegram received is 0~63 . Such as parameter settings is the scene 1, communication object "Scene" sends the scene for 0.

964	Up/Down, Blind	Btn 1 - {{Blind}}	1bit	C,W,T	1.008 up/down
965	Stop/Adjust, Blind	Btn 1 - {{Blind}}	1bit	C,W,T	1.007 step

This two communication objects are used to control the blind up,down, stop:

Obj.964: Used for sending the telegram to the bus, to control blind up/down. Telegrams:

1—Move down

0—Move up

Obj.965: Used for sending the telegram to the bus, to stop curtain movement. Telegrams: 1—Stop					
964	Register value	Btn 1 - {{Shift register}}	1byte	C,W,T	5.010 counter pulses
The communication object is used to send the value of shift register.					
964	Object1-On/Off	Btn 1 - {{Multiple operation}}	1bit	C,W,T	1.001 switch
	Object1-Up/Down		1bit	C,W,T	1.008 up/down
	Object1-SceneControl		1byte	C,T	18.001 scene control
	Object1-Percentage		1byte	C,T	5.001 percentage(0..100%)
	Object1-Unsigned value		1byte	C,T	5.010 counter pulses
The communication object is object of multiple operation, up to activate 4 objects at the same time, and operation once can send the value of 4 different datatype objects to the bus via these objects. Range of values that can be sent are determined by the datatype, and the datatype is determined by the parameter setting.					
964	Short, Delay mode	Btn 1 - {{Delay mode}}	1bit	C,T	1.001 switch
			4bit		3.007 dimming
			1byte		5.010 counter pulses
965	Long, Delay mode	Btn 1 - {{Delay mode}}	1bit	C,T	1.001 switch
			4bit		3.007 dimming
			1byte		5.010 counter pulses
These communication objects are used to send the value of delay mode to the bus, distinguish long and short operation. Range of values that can be sent are determined by the datatype, and the datatype is determined by the parameter setting.					
964	Operation mode	Btn 1 - {{RTC mode}}	1byte	C,T	20.102 HVAC mode
964	Comfort mode	Btn 1 - {{RTC mode}}	1bit	C,T	1.003 enable
965	Economy mode	Btn 1 - {{RTC mode}}	1bit	C,T	1.003 enable
966	Frost/Heat protection mode	Btn 1 - {{RTC mode}}	1bit	C,T	1.003 enable
	Standby mode				
967	Standby mode	Btn 1 - {{RTC mode}}	1bit	C,T	1.003 enable
These communication objects are used to send the RTC operation mode status to the bus. When 1 byte: object 964 is visible, telegrams: 1-Comfort, 2-Standby, 3-Economy, 4-Protection, other reserved.					

When 1bit:

Object 964—Comfort mode

Object 965—Economy mode

Object 966—Protection mode

Object 967—Standby mode

Only corresponding object send telegram “1” when activate one mode. When 1 bit standby object is not enable, three objects comfort, economy, protection all send 0 to activate standby mode. When 1 bit standby object is enable, only standby object sends 1 to activate standby mode.

964	String	Btn 1 - {{String}}	14byt es	C,T	16.001 character string (ISO 8859-1)
The communication object is used to send the sting to the bus.					
968	Disable	Btn 1 - {...}	1bit	C,W	1.003 enable
The communication object is used to disable/enable the function of contact input, apply to all the above functions.					
969	LED status	Btn 1 - {...}	1bit 1byte	C,W,T,U	1.001 switch 5.010 counter pulses
The communication object is used to control LED status via the bus, and also can receive status feedback. Range of values that can be sent are determined by the datatype, and the datatype is determined by the parameter setting.					

Table 6.7 “Button” communication object table

6.8. “Logic” Communication Object

6.8.1. “AND/OR/XOR” Communication Object

Numbe	Name	Object Function	Descript	Group Ad	Length	C	R	W	T	U	Data Type	Priority
11	1st Logic	Input a			1 bit	C	-	W	T	U	boolean	Low
12	1st Logic	Input b			1 bit	C	-	W	T	U	boolean	Low
13	1st Logic	Input c			1 bit	C	-	W	T	U	boolean	Low
14	1st Logic	Input d			1 bit	C	-	W	T	U	boolean	Low
15	1st Logic	Input e			1 bit	C	-	W	T	U	boolean	Low
16	1st Logic	Input f			1 bit	C	-	W	T	U	boolean	Low
17	1st Logic	Input g			1 bit	C	-	W	T	U	boolean	Low
18	1st Logic	Input h			1 bit	C	-	W	T	U	boolean	Low
19	1st Logic	Logic result			1 bit	C	-	-	T	-	boolean	Low

Fig.6.8.1 “AND/OR/XOR” communication object

NO.	Object Function	Name	Data Type	Flag	DPT
11/.../1 8	Input x	{{1st Logic}}	1bit	C,W,T,U	1.002 boolean
<p>The communication object is used to receive the value of logical input Input x.</p> <p>The name in parentheses changes with the parameter “Description for logic function”. If description is empty, display “1st Logic” by default. The same below.</p>					
19	Logic result	{{1st Logic}}	1bit	C,T	1.002 boolean
<p>The communication object is used to send the results of logical operation.</p>					

Table 6.8.1 “AND/OR/XOR” communication object table

6.8.2. “Gate forwarding” Communication Object

Number	Name	Object Function	Description	Group Ad	Length	C	R	W	T	U	Data Type	Priority
11	1st Logic	Gate value select			1 byte	C	-	W	-	-	scene number	Low
12	1st Logic	Input A			1 bit	C	-	W	-	-	switch	Low
13	1st Logic	Input B			1 bit	C	-	W	-	-	switch	Low
14	1st Logic	Input C			1 bit	C	-	W	-	-	switch	Low
15	1st Logic	Input D			1 bit	C	-	W	-	-	switch	Low
16	1st Logic	Output A			1 bit	C	-	-	T	-	switch	Low
17	1st Logic	Output B			1 bit	C	-	-	T	-	switch	Low
18	1st Logic	Output C			1 bit	C	-	-	T	-	switch	Low
19	1st Logic	Output D			1 bit	C	-	-	T	-	switch	Low

Fig.6.8.2 “Gate forwarding” communication object

NO.	Object Function	Name	Data Type	Flag	DPT
11	Gate value select	{{1st Logic}}	1byte	C,W	17.001 scene number
The communication object is used to select the scene of logical gate forwarding.					
12/.../1 5	Input x	{{1st Logic}}	1bit 4bit 1byte	C,W	1.001 switch 3.007 dimming control 5.010 counter pulses(0..255)
The communication object is used to receive the value of the logic gate input Input x.					
16/.../1 9	Output x	{{1st Logic}}	1bit 4bit 1byte	C,T	1.001 switch 3.007 dimming control 5.010 counter pulses(0..255)
The communication object is used to output the value forwarded by the logic gate. The output value is the same as the input value, but one input can be forwarded into one or more outputs, set by parameters.					

Table 6.8.2 “Gate forwarding” communication object table

6.8.3. “Threshold comparator” Communication Object

	Number	Name	Object Function	Description	Group Address	Length	C	R	W	T	U	Data Type	Priority
■	11	1st Logic	Threshold value input			4 bit	C	-	W	-	U	dimming control	Low
■	11	1st Logic	Threshold value input			1 byte	C	-	W	-	U	counter pulses (0..255)	Low
■	11	1st Logic	Threshold value input			2 bytes	C	-	W	-	U	pulses	Low
■	11	1st Logic	Threshold value input			2 bytes	C	-	W	-	U	2-byte signed value	Low
■	11	1st Logic	Threshold value input			2 bytes	C	-	W	-	U	2-byte float value	Low
■	11	1st Logic	Threshold value input			4 bytes	C	-	W	-	U	counter pulses (unsigned)	Low
■	11	1st Logic	Threshold value input			2 bytes	C	-	W	-	U	temperature (°C)	Low
■	11	1st Logic	Threshold value input			2 bytes	C	-	W	-	U	humidity (%)	Low
■	11	1st Logic	Threshold value input			2 bytes	C	-	W	-	U	lux (Lux)	Low
■	19	1st Logic	Logic result			1 bit	C	-	-	T	-	boolean	Low

Fig.6.8.3 “Threshold comparator” communication object

NO.	Object Function	Name	Data Type	Flag	DPT
11	Threshold value input	{{1st Logic}}	4bit 1byte 2bytes 4bytes	C,W, U	3.007 dimming 5.010 counter pulses 7.001 pulses 12.001 counter pulses 8.x signed value 9.x float value 9.001 temperature 9.007 humidity 9.004 lux
The communication object is used to input threshold value.					
19	Logic result	{{1st Logic}}	1bit	C,T	1.002 boolean
The communication object is used to send the results of logical operation. That is, the value that should be sent after the object input threshold is compared with the setting threshold value.					

Table 6.8.3 “Threshold comparator” communication object table

6.8.4. "Format convert" Communication Object

Numbe	Name	Object Function	Descript	Group Ad	Length	C	R	W	T	U	Data Type	Priority
11	1st Logic	Input 1bit-bit0			1 bit	C	-	W	-	U	boolean	Low
12	1st Logic	Input 1bit-bit1			1 bit	C	-	W	-	U	boolean	Low
19	1st Logic	Output 2bit			2 bit	C	-	-	T	-	switch control	Low

"2x1bit -> 1x2bit"function: converts two 1bit values to a 2bit value, such as Input bit1=1, bit0=0->

Output 2bit=2

Numbe	Name	Object Function	Descript	Group Ad	Length	C	R	W	T	U	Data Type	Priority
11	1st Logic	Input 1bit-bit0			1 bit	C	-	W	-	U	boolean	Low
12	1st Logic	Input 1bit-bit1			1 bit	C	-	W	-	U	boolean	Low
13	1st Logic	Input 1bit-bit2			1 bit	C	-	W	-	U	boolean	Low
14	1st Logic	Input 1bit-bit3			1 bit	C	-	W	-	U	boolean	Low
15	1st Logic	Input 1bit-bit4			1 bit	C	-	W	-	U	boolean	Low
16	1st Logic	Input 1bit-bit5			1 bit	C	-	W	-	U	boolean	Low
17	1st Logic	Input 1bit-bit6			1 bit	C	-	W	-	U	boolean	Low
18	1st Logic	Input 1bit-bit7			1 bit	C	-	W	-	U	boolean	Low
19	1st Logic	Output 1byte			1 byte	C	-	-	T	-	counter pulses (0..255)	Low

"8x1bit -> 1x1byte"function: converts eight 1bit values to a 1byte value, such as Input bit2=1, bit1=1, bit0=1,other bits are 0-> Output 1byte=7

Numbe	Name	Object Function	Descript	Group Ad	Length	C	R	W	T	U	Data Type	Priority
11	1st Logic	Input 1byte			1 byte	C	-	W	-	U	counter pulses (0..255)	Low
19	1st Logic	Output 2byte			2 bytes	C	-	-	T	-	pulses	Low

"1x1byte -> 1x2byte"function: converts one 1byte values to a 2byte value, such as Input 1byte=125-> Output 2byte=125.Although the value remains the same, the data type of the value is different.

Numbe	Name	Object Function	Descript	Group Ad	Length	C	R	W	T	U	Data Type	Priority
11	1st Logic	Input 1byte-low			1 byte	C	-	W	-	U	counter pulses (0..255)	Low
12	1st Logic	Input 1byte-high			1 byte	C	-	W	-	U	counter pulses (0..255)	Low
19	1st Logic	Output 2byte			2 bytes	C	-	-	T	-	pulses	Low

"2x1byte -> 1x2byte"function: converts two 1byte values to a 2byte value, such as Input 1byte-low = 255 (\$FF), Input 1byte-high = 100 (\$64) -> Output 2byte = 25855 (\$64 FF)

Numbe	Name	Object Function	Descript	Group Ad	Length	C	R	W	T	U	Data Type	Priority
11	1st Logic	Input 2byte-low			2 bytes	C	-	W	-	U	pulses	Low
12	1st Logic	Input 2byte-high			2 bytes	C	-	W	-	U	pulses	Low
19	1st Logic	Output 4byte			4 bytes	C	-	-	T	-	counter pulses (unsigned)	Low

"2x2byte -> 1x4byte"function: converts two 2 byte values to a 4byte value, such as Input 2byte-low = 65530 (\$FF FA), Input 2byte-high = 32768 (\$80 00)-> Output 2byte = 2147549178 (\$80 00 FF FA)

Numbe	Name	Object Function	Descript	Group Ad	Length	C	R	W	T	U	Data Type	Priority
11	1st Logic	Input 1byte			1 byte	C	-	W	-	U	counter pulses (0..255)	Low
12	1st Logic	Output 1bit-bit0			1 bit	C	-	-	T	-	boolean	Low
13	1st Logic	Output 1bit-bit1			1 bit	C	-	-	T	-	boolean	Low
14	1st Logic	Output 1bit-bit2			1 bit	C	-	-	T	-	boolean	Low
15	1st Logic	Output 1bit-bit3			1 bit	C	-	-	T	-	boolean	Low
16	1st Logic	Output 1bit-bit4			1 bit	C	-	-	T	-	boolean	Low
17	1st Logic	Output 1bit-bit5			1 bit	C	-	-	T	-	boolean	Low
18	1st Logic	Output 1bit-bit6			1 bit	C	-	-	T	-	boolean	Low
19	1st Logic	Output 1bit-bit7			1 bit	C	-	-	T	-	boolean	Low

“1x1byte --> 8x1bit” function: converts one 1byte values to eight 1but value, such as Input 1byte=200 --> Output bit0=0, bit1=0, bit2=0, bit3=1, bit4=0, bit5=0, bit6=1, bit7=1

Numbe	Name	Object Function	Descript	Group Ad	Length	C	R	W	T	U	Data Type	Priority
11	1st Logic	Input 2byte			2 bytes	C	-	W	-	U	pulses	Low
18	1st Logic	Output 1byte-low			1 byte	C	-	-	T	-	counter pulses (0..255)	Low
19	1st Logic	Output 1byte-high			1 byte	C	-	-	T	-	counter pulses (0..255)	Low

“1x2byte --> 2x1byte”function: converts one 2byte values to two 2byte value, such as Input 2byte = 55500 (\$D8 CC) --> Output 1byte-low = 204 (\$CC), Output 1byte-high =216 (\$D8)

Numbe	Name	Object Function	Descript	Group Ad	Length	C	R	W	T	U	Data Type	Priority
11	1st Logic	Input 4byte			4 bytes	C	-	W	-	U	counter pulses (unsigned)	Low
18	1st Logic	Output 2byte-low			2 bytes	C	-	-	T	-	pulses	Low
19	1st Logic	Output 2byte-high			2 bytes	C	-	-	T	-	pulses	Low

“1x4byte --> 2x2byte”function: converts one 4byte values to two 2byte value, such as Input 4byte = 78009500 (\$04 A6 54 9C) --> Output 2byte-low = 21660 (\$54 9C), Output 2byte-high =1190 (\$04 A6)

Numbe	Name	Object Function	Descript	Group Ad	Length	C	R	W	T	U	Data Type	Priority
11	1st Logic	Input 3byte			3 bytes	C	-	W	-	U	RGB value 3x(0..255)	Low
17	1st Logic	Output 1byte-low			1 byte	C	-	-	T	-	counter pulses (0..255)	Low
18	1st Logic	Output 1byte-middle			1 byte	C	-	-	T	-	counter pulses (0..255)	Low
19	1st Logic	Output 1byte-high			1 byte	C	-	-	T	-	counter pulses (0..255)	Low

“1x3byte --> 3x1byte”function: converts one 3byte values to three 1byte value, such as Input 3byte = \$78 64 C8--> Output 1byte-low = 200 (\$C8) , Output 1byte-middle = 100 (\$64) , Output 1byte-high =120 (\$78)

Numbe	Name	Object Function	Descript	Group Ad	Length	C	R	W	T	U	Data Type	Priority
11	1st Logic	Input 1byte-low			1 byte	C	-	W	-	U	counter pulses (0..255)	Low
12	1st Logic	Input 1byte-middle			1 byte	C	-	W	-	U	counter pulses (0..255)	Low
13	1st Logic	Input 1byte-high			1 byte	C	-	W	-	U	counter pulses (0..255)	Low
19	1st Logic	Output 3byte			3 bytes	C	-	-	T	-	RGB value 3x(0..255)	Low

“3x1byte --> 1x3byte”function: converts three 1byte values to a 3byte value, such as Input 1byte-low = 150 (\$96), Input 1byte-middle = 100 (\$64), Input 1byte-high = 50 (\$32)--> Output 3byte = \$32 64 96

Fig.6.8.4 “Format convert” communication object

NO.	Object Function	Name	Data Type	Flag	DPT
11	Input ...	{{1st Logic}}	1bit	C,W,U	1.001 switch
			1byte		5.010 counter pulses(0..255)
			2bytes		7.001 pulses
			3bytes		232.600 RGB value 3x(0..255)
			4bytes		12.001 counter pulses
The communication object is used to input a value that needs to be converted.					
19	Output ...	{{1st Logic}}	1bit	C,T	1.001 switch
			2bit		2.001 switch control
			1byte		5.010 counter pulses(0..255)
			2bytes		7.001 pulses
			3bytes		232.600 RGB value 3x(0..255)
4bytes	12.001 counter pulses				
The communication object is used to output the converted value.					

Table 6.8.4 "Format convert" communication object table

6.8.5. "Gate function" Communication Object

Numbe	Name	Object Function	Descript	Group Ad	Length	C	R	W	T	U	Data Type	Priority
11	1st Logic	Input			1 bit	C	-	W	-	-	switch	Low
12	1st Logic	Gate input			1 bit	C	-	W	-	-	boolean	Low
19	1st Logic	Output			1 bit	C	-	-	T	-	switch	Low
Input/Output - 1bit[On/Off]												
11	1st Logic	Input			1 byte	C	-	W	-	-	percentage (0..100%)	Low
12	1st Logic	Gate input			1 bit	C	-	W	-	-	boolean	Low
19	1st Logic	Output			1 byte	C	-	-	T	-	percentage (0..100%)	Low
Input/Output - 1byte[0..100%]												
11	1st Logic	Input			1 byte	C	-	W	-	-	counter pulses (0..255)	Low
12	1st Logic	Gate input			1 bit	C	-	W	-	-	boolean	Low
19	1st Logic	Output			1 byte	C	-	-	T	-	counter pulses (0..255)	Low
Input/Output - 1byte[0..255]												
11	1st Logic	Input			2 bytes	C	-	W	-	-	temperature (°C)	Low
12	1st Logic	Gate input			1 bit	C	-	W	-	-	boolean	Low
19	1st Logic	Output			2 bytes	C	-	-	T	-	temperature (°C)	Low
Input/Output - 2byte[Float]												

Numbe	Name	Object Function	Descript	Group Ad	Length	C	R	W	T	U	Data Type	Priority
11	1st Logic	Input			2 bytes	C	-	W	-	-	pulses	Low
12	1st Logic	Gate input			1 bit	C	-	W	-	-	boolean	Low
19	1st Logic	Output			2 bytes	C	-	-	T	-	pulses	Low

Input/Output - 2byte[0..65535]

Fig.6.8.5 "Gate function" communication object

NO.	Object Function	Name	Data Type	Flag	DPT
11	Input	{{1st Logic}}	1bit	C,W	1.001 switch
			1byte		5.001 percentage
			2bytes		5.010 counter pulses
					9.001 temperature
					7.001 pulses
The communication object is used to input a value that needs to gate filter.					
12	Gate input	{{1st Logic}}	1bit	C,W	1.002 boolean
The communication object is used to control the switch status of gate input. Input signal is allowed to pass when gate open, then output, and the current input status is still sent if there is a change; Can not pass when gate close.					
13	Output	{{1st Logic}}	bit	C,T	1.001 switch
			1byte		5.001 percentage
			2bytes		5.010 counter pulses
					9.001 temperature
					7.001 pulses
The communication object is used to output the value after gate filtering. Only when gate input status is open, output is available, defined by the object "Gate input".					

Table 6.8.5 "Gate function" communication object table

6.8.6. "Delay function" Communication Object

Numbe	Name	Object Function	Descript	Group Ad	Length	C	R	W	T	U	Data Type	Priority
11	1st Logic	Input			1 bit	C	-	W	-	-	switch	Low
19	1st Logic	Output			1 bit	C	-	-	T	-	switch	Low
Input/Output - 1bit[On/Off]												
Numbe	Name	Object Function	Descript	Group Ad	Length	C	R	W	T	U	Data Type	Priority
11	1st Logic	Input			1 byte	C	-	W	-	-	percentage (0..100%)	Low
19	1st Logic	Output			1 byte	C	-	-	T	-	percentage (0..100%)	Low
Input/Output - 1byte[0..100%]												
Numbe	Name	Object Function	Descript	Group Ad	Length	C	R	W	T	U	Data Type	Priority
11	1st Logic	Input			1 byte	C	-	W	-	-	counter pulses (0..255)	Low
19	1st Logic	Output			1 byte	C	-	-	T	-	counter pulses (0..255)	Low
Input/Output - 1byte[0..255]												
Numbe	Name	Object Function	Descript	Group Ad	Length	C	R	W	T	U	Data Type	Priority
11	1st Logic	Input			2 bytes	C	-	W	-	-	temperature (°C)	Low
19	1st Logic	Output			2 bytes	C	-	-	T	-	temperature (°C)	Low
Input/Output - 2byte[Float]												
Numbe	Name	Object Function	Descript	Group Ad	Length	C	R	W	T	U	Data Type	Priority
11	1st Logic	Input			2 bytes	C	-	W	-	-	pulses	Low
19	1st Logic	Output			2 bytes	C	-	-	T	-	pulses	Low
Input/Output - 2byte[0..65535]												

Fig.6.8.6 "Delay function" communication object

NO.	Object Function	Name	Data Type	Flag	DPT
11	Input	{{1st Logic}}	1bit	C,W	1.001 switch
			1byte		5.001 percentage
			2bytes		5.010 counter pulses
					9.001 temperature
					7.001 pulses
The communication object is used to input a value that needs to delay.					
19	Output	{{1st Logic}}	1bit	C,T	1.001 switch
			1byte		5.001 percentage
			2bytes		5.010 counter pulses
					9.001 temperature
					7.001 pulses
The communication object is used to output that needs to delay converted value, delay time is defined by the parameter.					

Table 6.8.6 "Delay function" communication object table

6.8.7. “Staircase lighting” Communication Object

Number	Name	Object Function	Description	Group Address	Length	C	R	W	T	U	Data Type	Priority
11	1st Logic	Trigger value			1 bit	C	-	W	-	-	trigger	Low
12	1st Logic	Light-on duration time			2 bytes	C	-	W	-	-	time (s)	Low
19	1st Logic	Output			1 bit	C	-	-	T	-	switch	Low
19	1st Logic	Output			1 byte	C	-	-	T	-	counter pulses (0..255)	Low

Fig.6.8.7 “Staircase lighting” communication object

NO.	Object Function	Name	Data Type	Flag	DPT
11	Trigger value	{{1st Logic}}	1bit	C,W	1.017 trigger
The communication object is used to receive the value to trigger staircase lighting.					
12	Light-on duration time	{{1st Logic}}	2bytes	C,W	7.005 time(s)
The communication object is used to modify the staircase light-on duration time, the modified range is referenced from the range defined by the parameter, take the limit value if exceeded.					
19	Output	{{1st Logic}}	1bit 1byte	C,T	1.001 switch 5.010 counter pulses
The communication object is used to output value 1 when trigger, and send value 2 after duration time. Telegram value is determined by the parameter setting datatype.					

Table 6.8.7 “Staircase lighting” communication object table

6.9. "Scene Group" Communication Object

	Number	Name	Object Function	Description	Group Address	Length	C	R	W	T	U	Data Type	Priority
	83	Scene Group	Main scene trigger			1 byte	C	-	W	-	-	scene number	Low
	84	1st Scene Group-Output 1	1bit value			1 bit	C	-	-	T	-	switch	Low
	85	1st Scene Group-Output 2	1bit value			1 bit	C	-	-	T	-	switch	Low
	86	1st Scene Group-Output 3	1bit value			1 bit	C	-	-	T	-	switch	Low
	87	1st Scene Group-Output 4	1bit value			1 bit	C	-	-	T	-	switch	Low
	88	1st Scene Group-Output 5	1bit value			1 bit	C	-	-	T	-	switch	Low
	89	1st Scene Group-Output 6	1bit value			1 bit	C	-	-	T	-	switch	Low
	90	1st Scene Group-Output 7	1bit value			1 bit	C	-	-	T	-	switch	Low
	91	1st Scene Group-Output 8	1bit value			1 bit	C	-	-	T	-	switch	Low

Fig.6.9 "Scene Group" communication object

NO.	Object Function	Name	Data Type	Flag	DPT
83	Main scene trigger	Scene Group	1byte	C,W	17.001 scene number
<p>This communication object triggers each output in the scene group to send a specific value to the bus by recalling the scene number. Telegrams: 0.. 63</p>					
84/..	1bit value 1byte unsigned value HVAC mode 2byte unsigned value Temperature	1st Scene Group-{{Output x}}	1bit 1byte 2byt es	C,T	1.001 switch 5.010 counter pulses 20.102 HVAC mode 7.001 pulses 9.001 temperature
<p>When a scene is recalled, the communication object is used to send the corresponding output value of the scene to the bus. If the output is not set to this scene, it will not be sent.</p> <p>A total of 8 scene groups can be set up, with 8 outputs per group.</p> <p>The name in parentheses changes with the parameter "Description for logic function". If description is empty, display "1st Scene Group-Output x" by default. The same below.</p>					

Table 6.9 "Scene Group" communication object table