

User manual

K-BUS KNX Smart Touch S7_V1.8

CHTI-7.0/120.1.22(Silver)

CHTI-7.0/120.1.23(Gray)

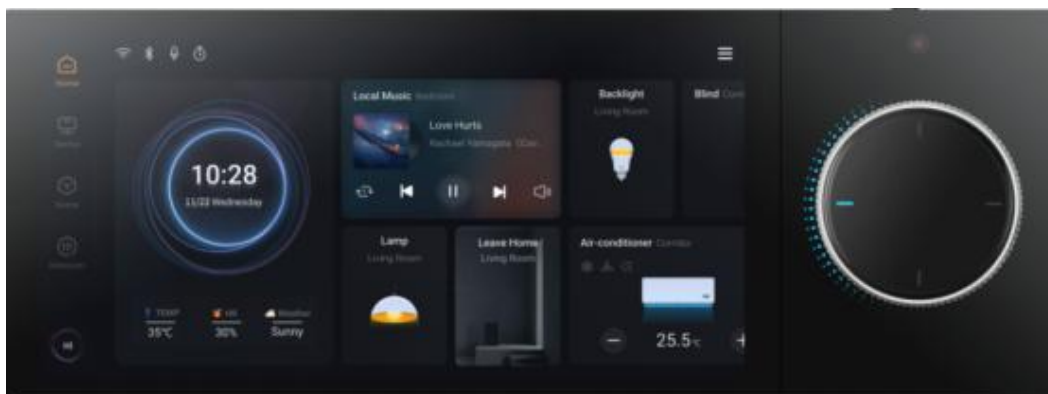

KNX/EIB Home and Building Control System

Attentions

1. Please keep devices away from strong magnetic field, high temperature, wet environment;

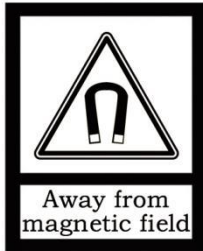

2. Do not fall the device to the ground or make them get hard impact;



3. Do not use wet cloth or volatile reagent to wipe the device;



4. Do not disassemble the devices.

S7 series includes KNX Smart Touch S7, S7 Extension Sub Panel, 4-buttons and S7 Extension Sub Panel, 4-buttons with Rotary. Among them, the S7 Extension Sub Panel needs to be used with KNX Smart Touch S7, and users can purchase the sub-panel according to their needs.

Products name	Product model
KNX Smart Touch S7	CHTI-7.0/120.1.22(Silver) CHTI-7.0/120.1.23(Gray)
S7 Extension Sub Panel, 4-buttons	CHPB-04/S7.1.00(White) CHPB-04/S7.1.01(Black)
S7 Extension Sub Panel, 4-buttons with Rotary	CHRB-04/S7.1.10(White, without camera) CHRB-04/S7.1.11(Black, without camera) CHRBC-04/S7.1.10(White, with camera) CHRBC-04/S7.1.11(Black, with camera)

Contents

Chapter 1 Summary	1
Chapter 2 Technical Date	2
Chapter 3 Dimension and Structural Diagram	2
3.1 Dimension Diagram	3
3.2 Structural Diagram	6
3.3 Installation and Disassembly instructions	7
3.3.1 KNX Smart Touch S7 Installation and Disassembly instructions	8
3.3.2 S7 Extension Sub Panel,4 buttons Installation instructions	11
3.3.3 S7 Extension Sub Panel, 4 buttons with Rotary Installation instructions	13
Chapter 4 Project Design and Programming	14
Chapter 5 Parameter setting description in the ETS	18
5.1 KNX Secure	18
5.2 Parameter window "General"	23
5.2.1 Parameter window "General setting"	23
5.2.2 Parameter window "Security setting"	29
5.2.3 Parameter window "Night mode setting"	31
5.2.4 Parameter window "Coordinates location setting"	34
5.2.5 Parameter window"Summer time setting"	36
5.2.6 Parameter window "Proximity setting"	38
5.2.7 Parameter window "Extension Sub Panel setting"	40
5.2.8 Parameter window "Advanced setting"	42
5.3 Parameter window "HVAC controller"	42
5.3.1 Parameter window "Controller x-Room temperature controller(RTC)"(x=1~6)	43
5.3.1.1 Parameter window "Setpoint"	51
5.3.1.2 Parameter window "Heating control/Cooling control/Heating/Cooling control"	59
5.3.1.3 Parameter window "Fan auto.control"	69

5.3.2 Parameter window "Cotroller x-Ventilation controller"(x=1~6)	75
5.4 Parameter window "Human Centric Lighting(HCL)"	82
5.5 Parameter window "Schedule function"	87
5.5.1 Parameter window "Schedule X"	87
5.6 Parameter window "Alarm function"	90
5.6.1 Parameter window "Alarm x"(x=1~24)	92
5.7 Parameter window "Logic function"	93
5.7.1 Parameter window "AND/OR/XOR"	95
5.7.2 Parameter window "Gate forwarding"	97
5.7.3 Parameter window "Threshold comparator"	99
5.7.4 Parameter window "Format convert"	102
5.7.5 Parameter window "Gate function"	103
5.7.6 Parameter window "Delay function"	105
5.7.7 Parameter window "Staircase lighting"	106
5.8 Parameter window "Scene group function"	108
5.9 Parameter window "Home page"	112
5.10 Parameter window "Display view"	114
5.11 Parameter window "KNX Channel"	116
5.11.1 Parameter window "Channel X"(X=1~120)	119
5.11.2 Parameter window of basic function	121
5.11.2.1.Switch	121
5.11.2.2.Press/Release switch	123
5.11.2.3.Relative dimming/brightness dimming/Relative&brightness dimming ...	124
5.11.2.4.Colour temperature dimming	126
5.11.2.5.RGB/RGBW/RGBCW/ dimming	128
5.11.2.6.Curtain and blind control	132
5.11.2.7.Air conditioner control	135
5.11.2.8.Room temperature unit control	139

5.11.2.9. Ventilation system control	150
5.11.2.10. Audio control	155
5.11.2.11. Energy metering value display	161
5.11.2.12. Temperature/Humidity sensor	164
5.11.2.13 Air quality detected value display	166
5.11.2.14. I/O sensor	174
5.11.2.15. Value sender	175
5.12 Parameter window "KNX Scene"	177
5.13 Parameter window "Internal sensor measurement"	179
Chapter 6 Description of Communication Object	183
6.1 "General" Communication Object	183
6.2 "Internal sensor" Communication Object	185
6.3 "Logic" Communication Object	186
6.3.1 "AND/OR/XOR" Communication Object	186
6.3.2 "Gate forwarding" Communication Object	187
6.3.3 "Threshold comparator" Communication Object	188
6.3.4 "Format convert" Communication Object	189
6.3.5 "Gate function" Communication Object	192
6.3.6 "Delay function" Communication Object	193
6.3.7 "Staircase lighting" Communication Object	195
6.4 "Scene Group setting" Communication Object	196
6.5 "HVAC controller" Communication Object	198
6.5.1 "Room temperature controller (RTC) " Communication Object	198
6.5.2 "Ventilation controller" Communication Object	205
6.6 "Human Centric Lighting(HCL)" Communication Object	206
6.7 "Schedule function" Communication Object	209
6.8 "Alarm function" Communication Object	210
6.9 "KNX Channel general" Communication Object	211

6.10 “KNX Channel X” Communication Object	212
6.10.1 “Switch” Communication Object	213
6.10.2 “Relative/Brightness/Relative&Brightnes dimming” Communication Object	214
6.10.3 “RGB/Colour and colour temperature control” Communication Object	215
6.10.4 “Curtain and Blind” Communication object	223
6.10.5 “Air conditioner control” Communication object	227
6.10.6 “Room temperature unit control” Communication object	230
6.10.7 “Ventilation system control” Communication object	236
6.10.8 “Audio control”Communication object	241
6.10.9 “Energy metering value display”Communication object	248
6.10.10 “Sensor” Communication object	250
6.10.11 “Value sender” Communication object	254
6.11 “KNX Scene” Communication object	256
6.12 “Extension function” Communication object	257

Chapter 1 Summary

KNX Smart Touch S7 is a 6.9-inch KNX smart control panel with a screen resolution of up to 1440*720. In addition to integrating KNX device control, it also connects to a SIP intercom system, combining indoor and outdoor communication into one entity.

The smart control integrates lighting, switches, dimming, curtains, value sender, color temperature, color control (RGB, RGBW, RGBCW), audio control, room temperature control, Air conditioner, Ventilation system control, etc. It not only supports displaying air quality, energy metering, device status, but also support various sensors such as proximity sensor, brightness sensor, temperature and humidity sensors, meets the requirements of most applications. Additionally, it supports schedule, logic function, scene group function to make your life smarter. As an intercom indoor unit, it supports wired network access and features such as address book import, contact management, SIP visual intercom calls, voice messages, security monitoring, virtual zone management, etc. It also supports various functions like SOS, lock screen, password access, etc.

This product also supports the integration of expand sub-panels. You can choose to purchase compatible sub-panel devices according to your needs, such as 4 button sub-panel, rotary sub-panel, rotary sub-panel with camera, etc. You can also customize the button and rotary functions through the screen, customize the ambient lighting color and flexibly combine applications.

KNX Smart Touch S7 powered from KNX bus, and need a 12-30V DC auxiliary supply voltage. It is available to assign the physical address and configure the parameters by engineering design tools ETS with .knxprod (support edition ETS5.7 or higher).

Chapter 2 Technical Data

Power Supply	Bus voltage	21-30V DC, via the KNX bus
	Bus current	<3.8mA/24V, <3.4mA/30V
	Bus consumption	<0.1W
Auxiliary Supply	Voltage	12-30V DC
	Current	<170mA/24V, <150mA/30V
	Consumption	<4.5W
Connection	KNX	Bus connection terminal(Red/Black)
	Auxiliary Supply	Bus connection terminal(Yellow/White)
	RJ45	For access to intercom system or connect Ethernet
Operation and display	push button&LED	For assigning the physical address
Proximity sensor	Normal:30cm	Enhanced:60cm
Temperature sensor	-40-80°C	
Humidity sensor	0-100%	
Temperature	Operation	- 5 °C ... + 45 °C
	Storage	-25 °C ... + 55 °C
	Transport	- 25 °C ... + 70 °C
Environment	Humidity	<93%, except dewing
Installation	In a conventional 86mm or 80mm wiring box	
Dimension/Weight	KNX Smart Touch S7: 180.0*86.0*36.0mm/0.5Kg	
	S7 Extension Sub Panel, 4 buttons: 45.0*86.0*11.8mm/0.1Kg	
	S7 Extension Sub Panel, 4 buttons with Rotary:	
	61.0*86.0*27.7mmmm/0.16Kg	

Chapter 3 Dimension and Structural Diagram

3.1 Dimension Diagram

3.1.1 KNX Smart Touch S7

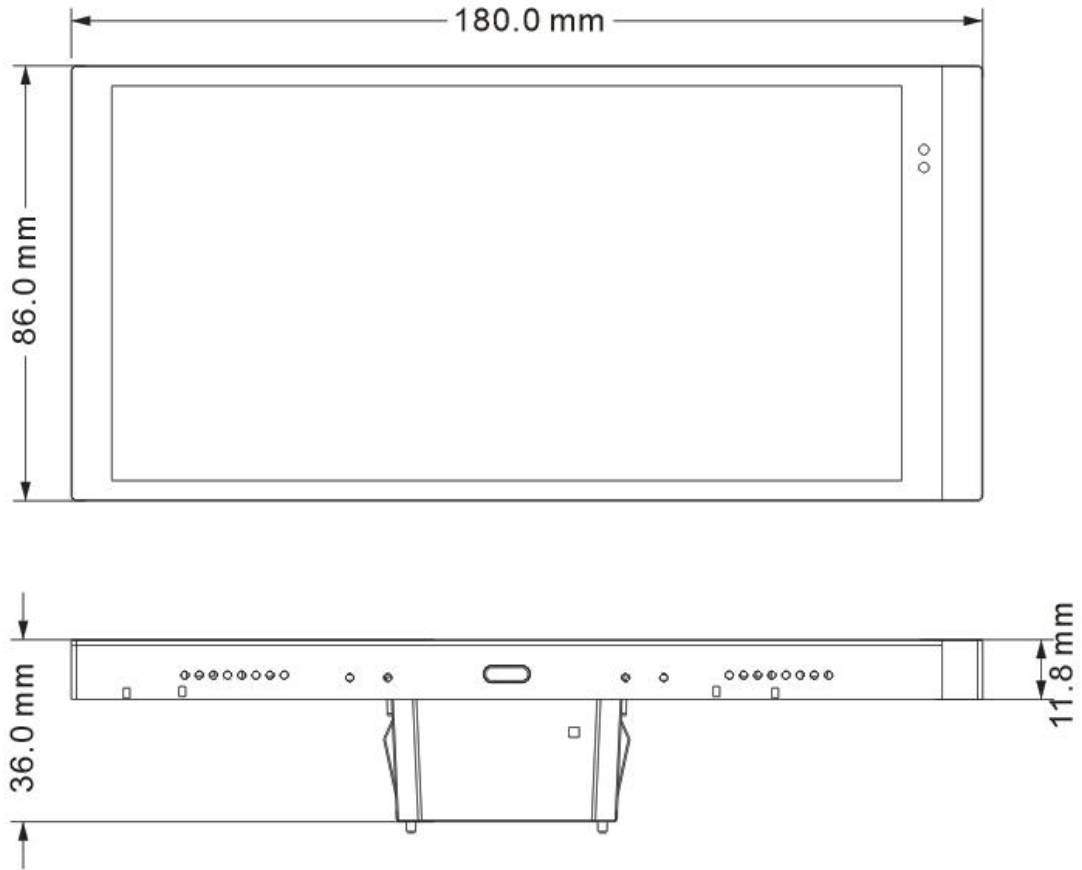

Fig.3.1.1(1) KNX Smart Touch S7



图 3.1.1(2) KNX Smart Touch S7 with S7 Extension Sub Panel, 4 buttons



图 3.1.1(3) KNX Smart Touch S7 with S7 Extension Sub Panel, 4 buttons with Rotary

3.1.2 S7 Extension Sub Panel,4 buttons

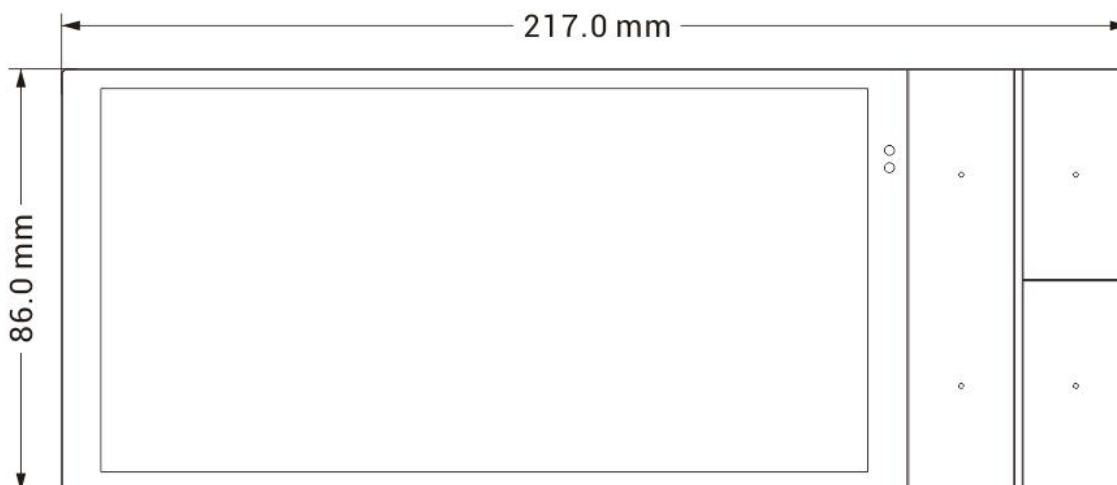

图 3.1.2 S7 Extension Sub Panel,4buttons

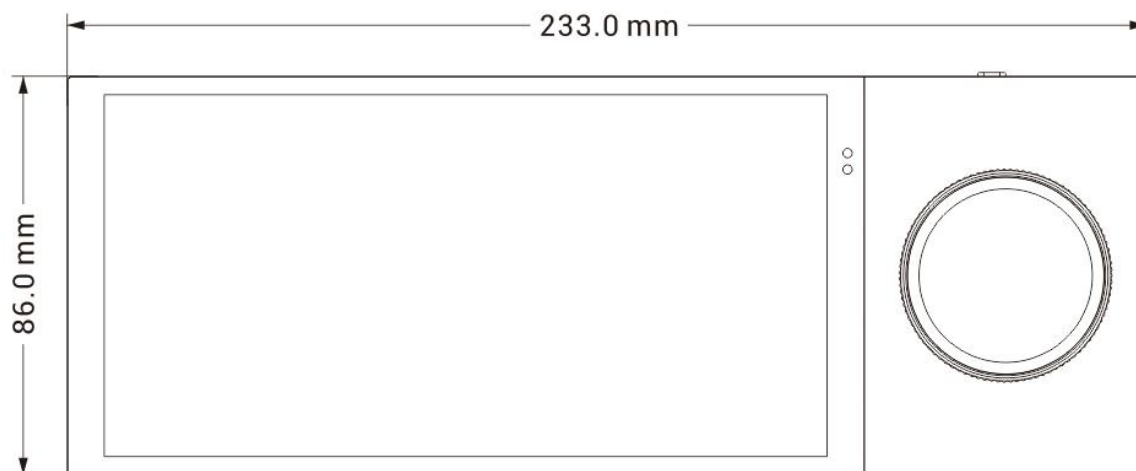
3.1.3 S7 Extension Sub Panel, 4 buttons with Rotary

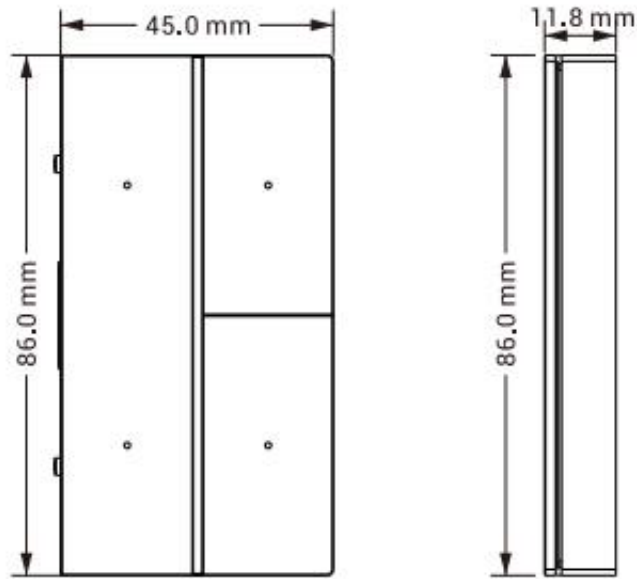

图 3.1.3 Extension Sub Panel,4 buttons with Rotary

3.2 Structural Diagram

3.2.1 KNX Smart Touch S7

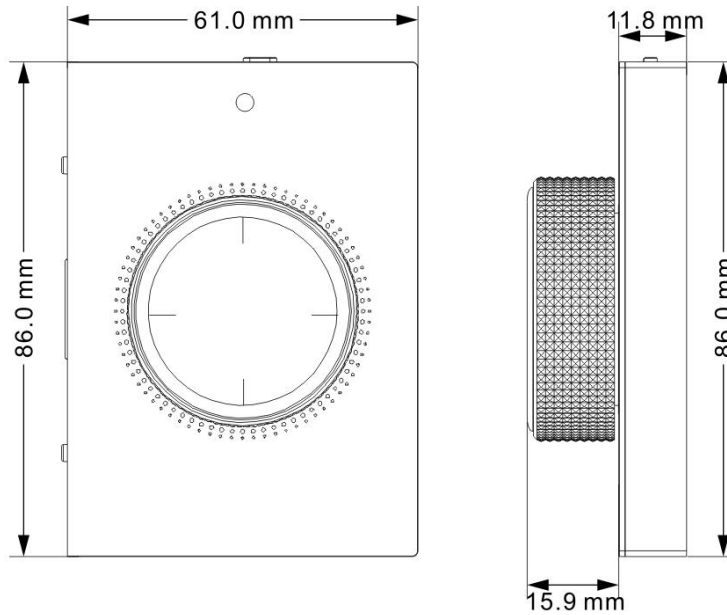
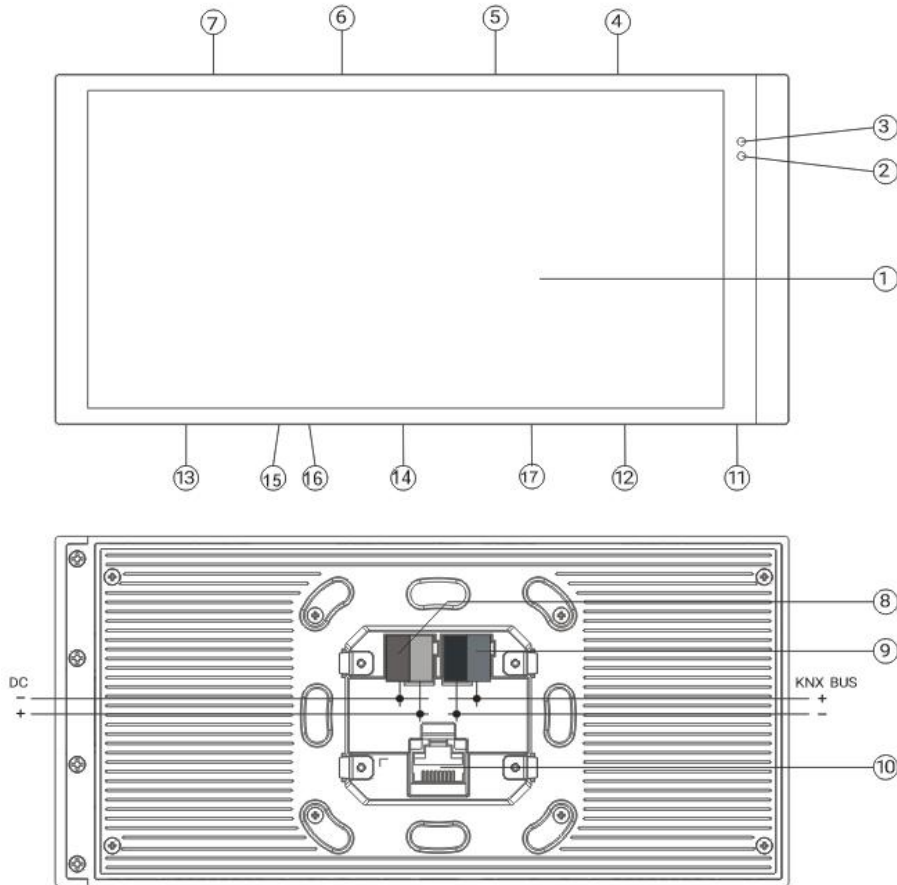
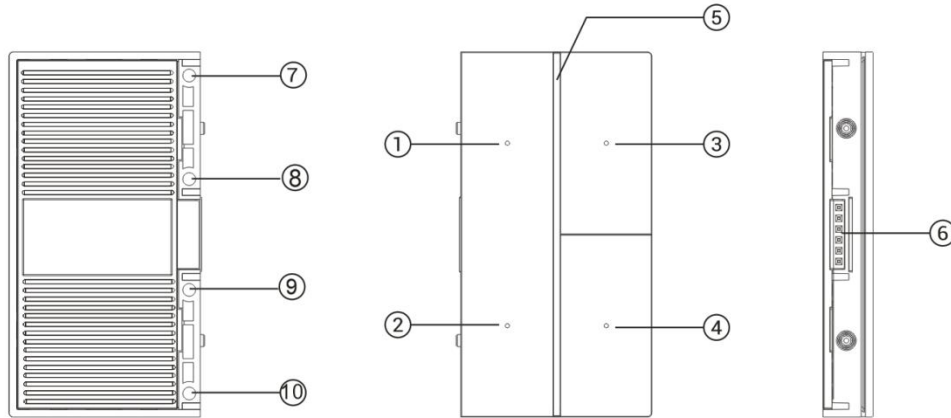

Fig.3.2.1 KNX Smart Touch S7 structural diagram

- ① Touch and display area
- ②③ Proximity sensor and brightness sensor
- ④-⑦: Microphone
- ⑧ Auxiliary supply connection terminal
- ⑨ KNX bus connection terminal
- ⑩ Ethernet port
- ⑪ Internal temperature and humidity sensor
- ⑫-⑬: Loudspeaker
- ⑭ Type-C interface
- ⑮-⑯: Programming button and LED
- ⑰ reset button

Reset the device to the factory configuration: press the programming button and hold for 4 seconds then release, repeat the operation for 4 times, and the interval between each operation is less than 3 seconds.

3.2.2 S7 Extension Sub Panel,4 buttons



3.2.2 S7 Extension Sub Panel,4 buttons

①-④ :Button 1-4

⑥Connection to screen

⑤ambient lighting

⑦-⑩screw hole

3.2.3 S7 Extension Sub Panel, 4 buttons with Rotary

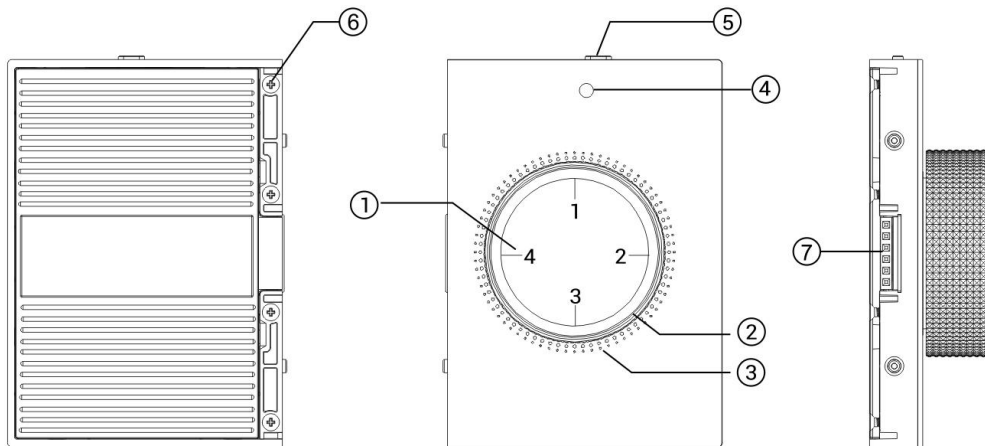

3.2.3 S7 Extension Sub Panel,4 buttons with Rotary

①: Button 1~4

②: Rotary button

③: Ambient lighting

④: Camera

⑤: Camera switch

⑥: screw hole

⑦: Interface connection to S7

3.3 Installation and Disassembly instructions

3.3.1 KNX Smart Touch S7 Installation and Disassembly instructions

Installation instructions

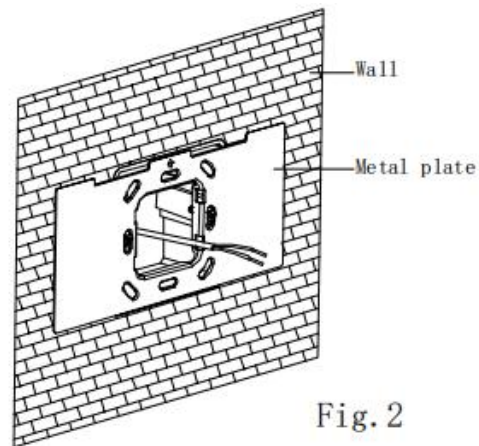
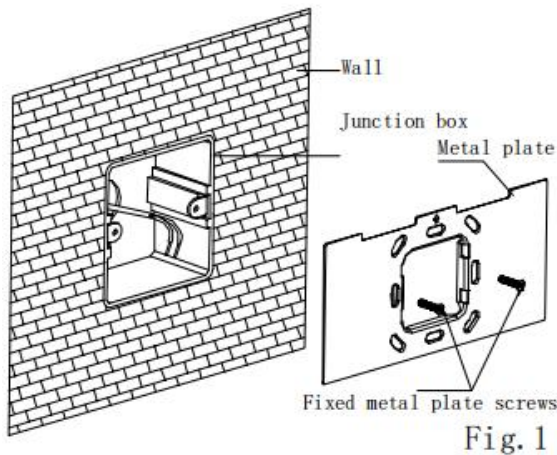

1. Install metal plate to the junction box on the wall with mounting screws.

Installation specification:

- (1) Remove the metal plate and fixed metal plate screws, thread the cable through the metal plate and fixed the metal plate to the 80 or 86 box with the screws. It is suggested that junction box should be parallel with the wall horizon, shown as Fig. 1;
- (2) Install the metal plate, shown as Fig. 2;
- (3) Screwdriver should not drive too strong when installed, otherwise it will result in the deformation of the metal plate.
- (4) The recommended strength is 0.6 ~ 0.8 N.M (6 ~ 8 Kgf.cm).

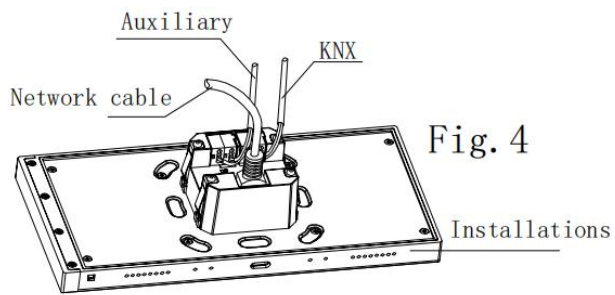
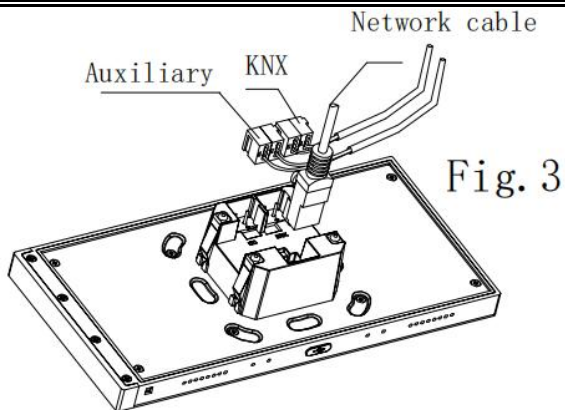

2.Remove the KNX bus connection terminal on the device and connect it correctly according to the wiring instructions.,shown as Fig.3;After wiring, install the KNX bus terminal of the connected wire into the installations, and connect the network cable with the installations,then the wiring installation is finished, as shown in Fig.4;

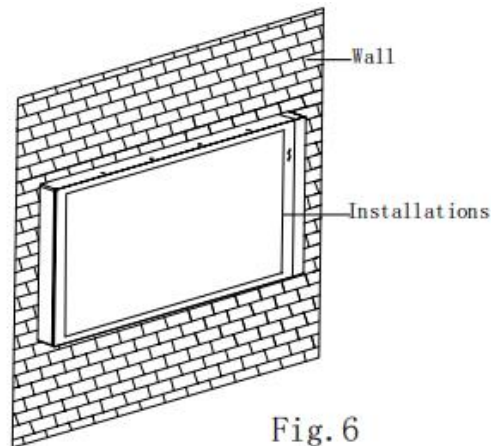
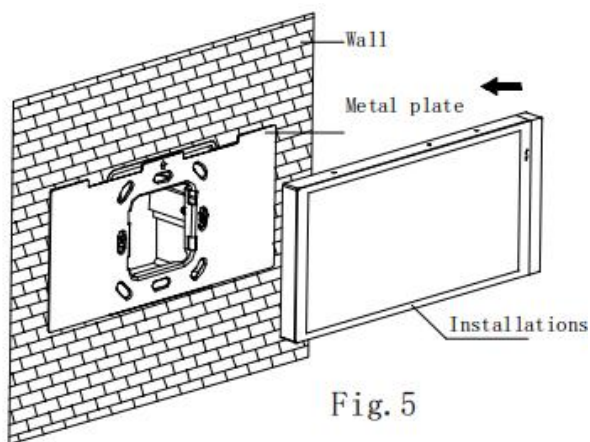

3.After connection of the device complete:

(1)Align the back of the installations to the mounting hole position of the metal plate, requiring the device to be parallel to the wall or the metal plate,push the installations into metal plate and attention should be paid to the shrapnel installation hole of the metal plate,until the shrapnel on the installations ia clamped into the metal plate,,shown as Fig.5;

(2)Complete installations installation,shown as Fig.6;

Disassembly instructions

Fig. 7

4. After finishing the installation, if disassembly is required, please perform this step:

Pull the installations out toward the horizontal direction and spring buckle and magnetic attraction fall off, then the disassembly is finished, shown as Fig.7;

3.3.2 S7 Extension Sub Panel,4 buttons Installation instructions

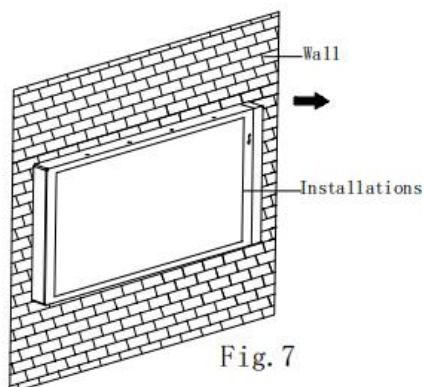
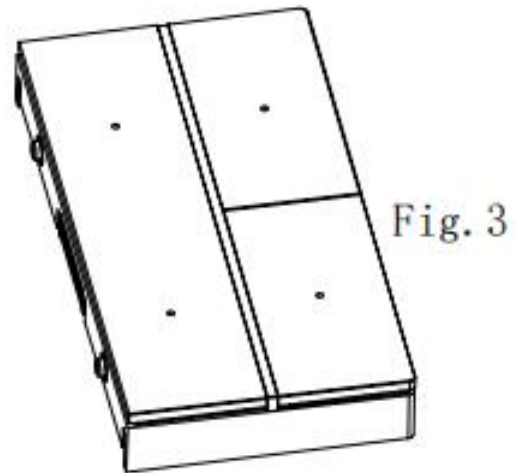
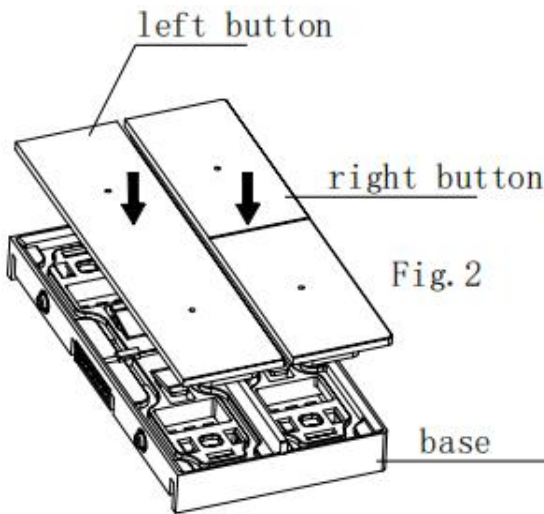
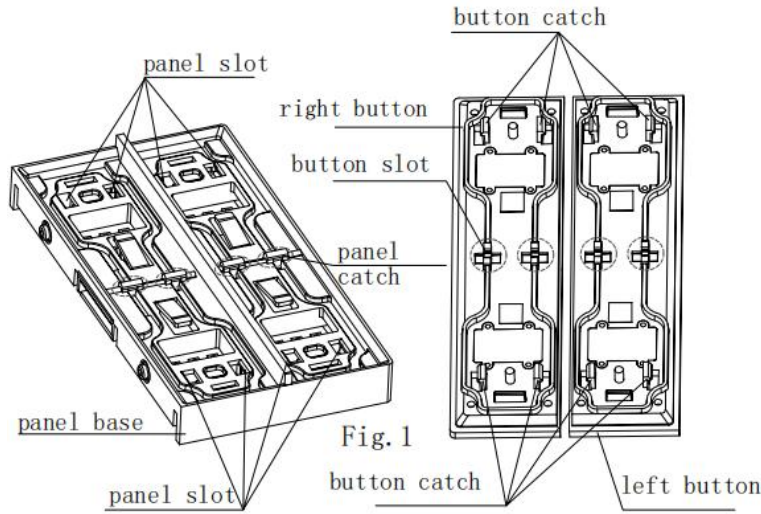

1.First,remove the panel base,button and identify their directions.Align the button catches with the slots in the panel bass.Next,press down on the button until button catches are completely snapped into the panel base.Button installation is complete.As shown in Fig.1,Fig.2, Fig.3;

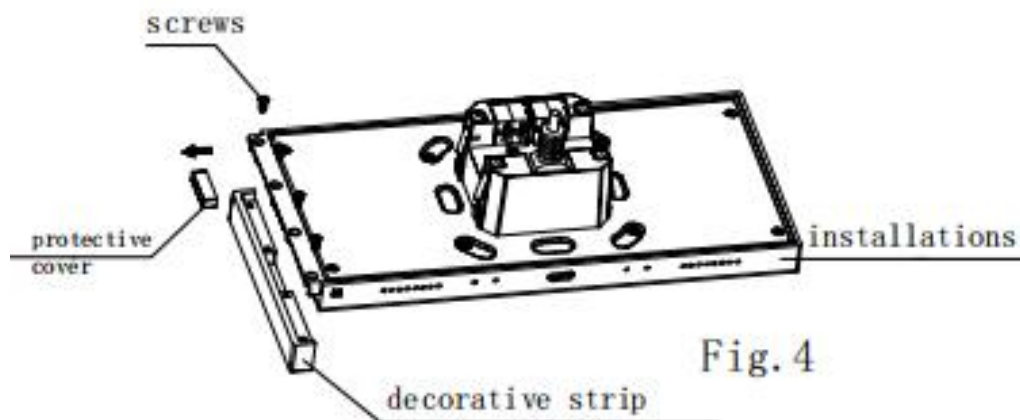

3.Remove the 4 screws that fixed the metal decorative strips on the KNX Smart Touch S7 and keep the screws,then remove the decorative strip and protective cover.As shown in Fig.4;

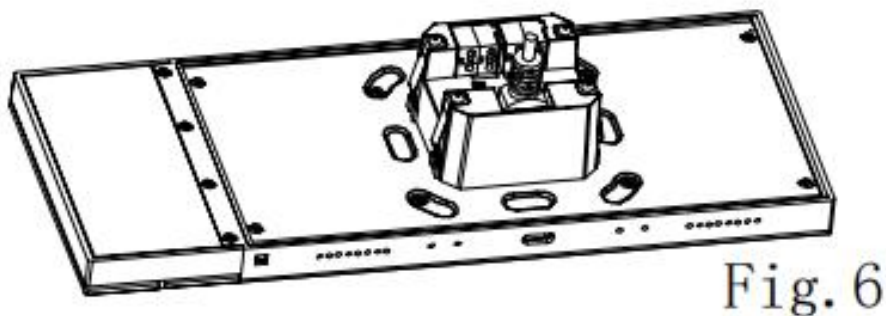
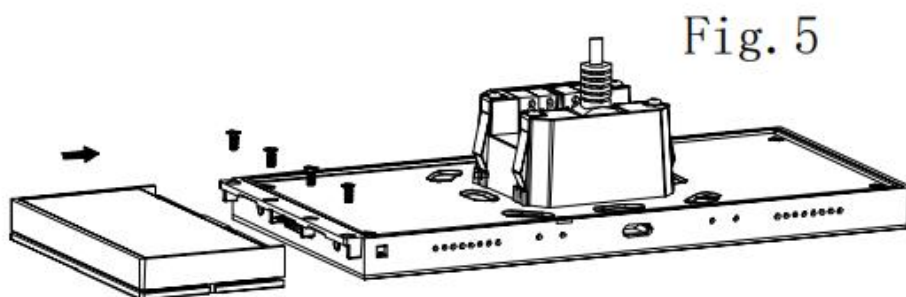

3.Assemble the 6PIN terminal of the S7 Extension Sub Panel with the connector block of the KNX Smart Touch S7 and fixed it with screws.As shown in Fig.5.;S7 Extension Sub Panel and KNX Smart Touch S7 installations complete.As shown in Fig.6;

3.3.3 S7 Extension Sub Panel, 4 buttons with Rotary Installation instructions

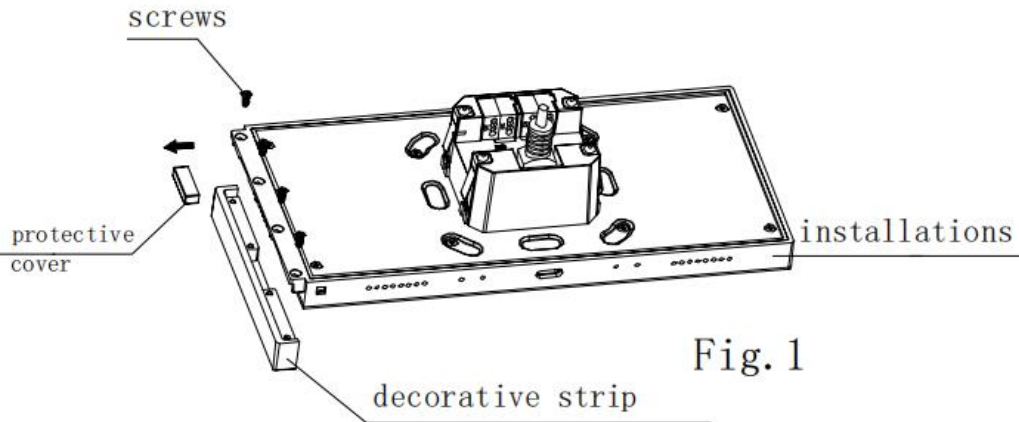

Fig. 1

1.Remove the 4 screws that fixed the metal decorative strips on the KNX Smart Touch S7 and keep the screws,then remove the decorative strip and protective cover.As shown in Fig.1;

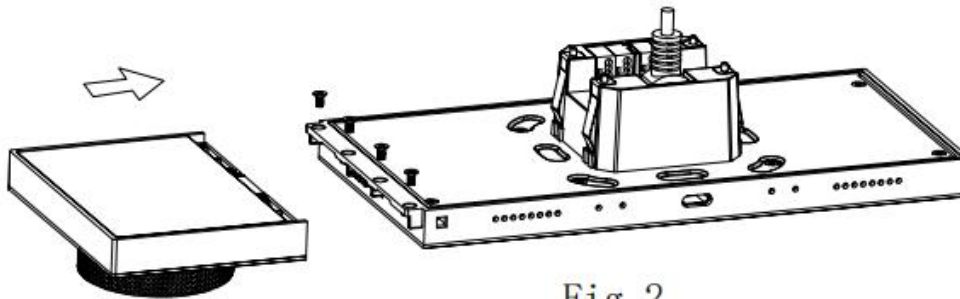

Fig. 2

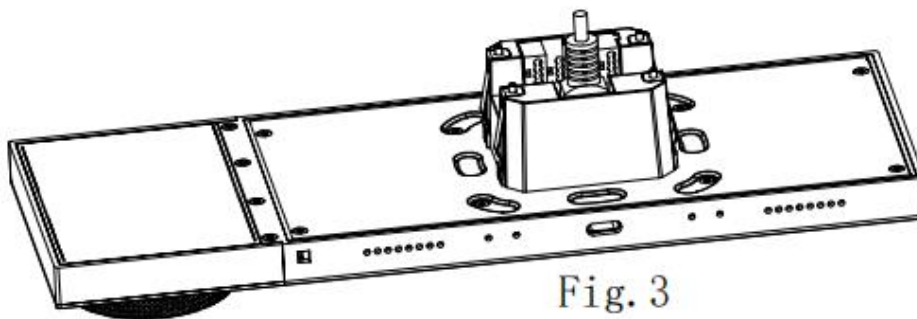

Fig. 3

2.Assemble the 6PIN terminal of the S7 Extension Sub Panel with the connector block of the KNX Smart Touch S7 and fixed it with screws.As shown in Fig.2;S7 Extension Sub Panel and KNX Smart Touch S7 installations complete.As shown in Fig.3;

Chapter 4 Project Design and Programming

Application	Maximum of communication objects	Maximum number of group addresses	Maximum number of associations	Secure group addresses
KNX Touch/Intercom/1.2	3042	4500	4500	1500

General function

General function includes security password, screen display, screen brightness, day/night mode , proximity , LED and ambient lighting settings.

Additionally, you can choose vertical or horizontal display, four default UI styles and set functions such as screen saver and screen lock.

Note: The function of vertical or horizontal display is only applicable to software version 4.1.0 or above.

Homepage shortcut function

On the home page, you can set shortcut operation functions to quickly control commonly used devices.

Device function setting

Adopts a grid UI style,supports up to 120 device and independent lock/unlock for each icon device.

Supports basic control functions including switch,dimming,blinds,value sender,color temperature, color control(RGB,RGBW,RGBCW),audio control,room temperature control,Air conditioner,Ventilation System control,Air quality and Energy Metering display,etc.

Switch indicator

To indicate the switch status of lighting device or other device.

Lighting Control

It is mainly used for switching lighting device or dimming lighting device. Dimming mode can be relative dimming, brightness dimming, relative+brightness dimming or brightness+colour temperature dimming.

RGB dimming and colour temperature

It is mainly used for RGB, RGBW and RGBCW LED dimming in absolute dimming way. RGBCW supports RGB lighting, colour temperature and brightness adjustment. And the colour temperature dimming is optional to normal control or directly control..

Curtain and blind control

To control open/close curtain, roller blind and venetian blind. Support to adjust the position and slat.

Air conditioner control

Support to the control function, including power on/off, setpoint temperature, mode, fan speed, vanes swing, timer, etc.

Room temperature control function

RTC is mainly used to control the room temperature, automatically and optimally control the heating and cooling according to the use of the room or the needs of the occupants.

Supports manually switching of heating/cooling control, support options for three-level fan speed and auto fan speed, four operation modes: comfort, standby, economy and protection mode.

The setting temperature supports absolute and relative settings, as well as adjustable temperature range settings. Supports 2-point and PI control.

Ventilation system control

Supporting 3-level fan speed adjustment, turn on or off heat recovery, filter life counter, filter overtime alarm and filter reset.

Auto control according to the concentration of PM2.5, VOC or CO₂, in addition to setting scene function.

Audio control

It is used to control background music playing, for example, power on/off, play/pause, previous track/next track, volume increase/decrease, mute, play modes, track name, artist name, album name, and so on.

Energy metering value display

Support current, voltage, power and energy (electricity energy) display configuration, these values are received from other actuators or metering gateway.

Air quality detected value display

Temperature, humidity, PM2.5, PM10, VOC, CO₂, AQI, brightness, wind speed and rain status displays can be set and these values are received from external sensor.

Value sender function

Values of different data types can be sent.

Scene control

Short operation for the scene recall, long operation can be set up for the scene storage.

Human Centric Lighting (HCL)

Automatically adjust brightness and color temperature based on the set time to create a comfortable lighting environment.

Schedule function

Supporting to timely send different types of value, up to 16 schedule. When enable schedule function, schedule can be operated from the screen. In screen, user can enable/disable schedule. In addition, schedule can be disabled through the bus.

Scene group function

By calling the scene number, up to eight output telegrams can be triggered. Each output has five different data type options. There are a total of 8 scene group function can be configured.

Logic function

Up to support 8 channels of logic, each channel up to support 8 inputs and 1 logic result.

Logic function support functions, including AND, OR, XOR, Gate forwarding, Threshold comparator, Format convert, Delay function and Staircase lighting.

Intercom function

Adopts a grid UI style, supports basic control functions including address book import, contact management, SIP visual intercom calls, voice messages, security monitoring, virtual zone management, etc.

Chapter 5 Parameter setting description in the ETS

5.1 KNX Secure

KNX Smart Touch S7 is a KNX device that complies with the KNX secure standard. That is, you can run the device in safe way.



Fig.5.1 (1) "KNX Secure" parameter window

The device with KNX secure will be displayed notes on ETS, as shown as Fig.5.1(1).

If secure commissioning is activated in ETS project, the following information must be considered during device debugging:



- ❖ It is essential to assign a project password as soon as a KNX Secure device is imported into a project. This will protect the project against unauthorized access.

The password must be kept in a safe place – access to the project is not possible without it (not even the KNX Association or device manufacturer will be able to access it)!

Without the project password, the commissioning key will not be able to be imported.

- ❖ A commissioning key is required when commissioning a KNX Secure device (first download). This key (FDSK = Factory Default Setup Key) is included on a sticker on the side of the device, and it must be imported into the ETS prior to the "first download":

✧ On the first download of the device, a window pops up in the ETS to prompt the user to enter the key, as shown in Fig.5.1 (2) below.

The certificate can also be read from the device using a QR scanner (recommended).

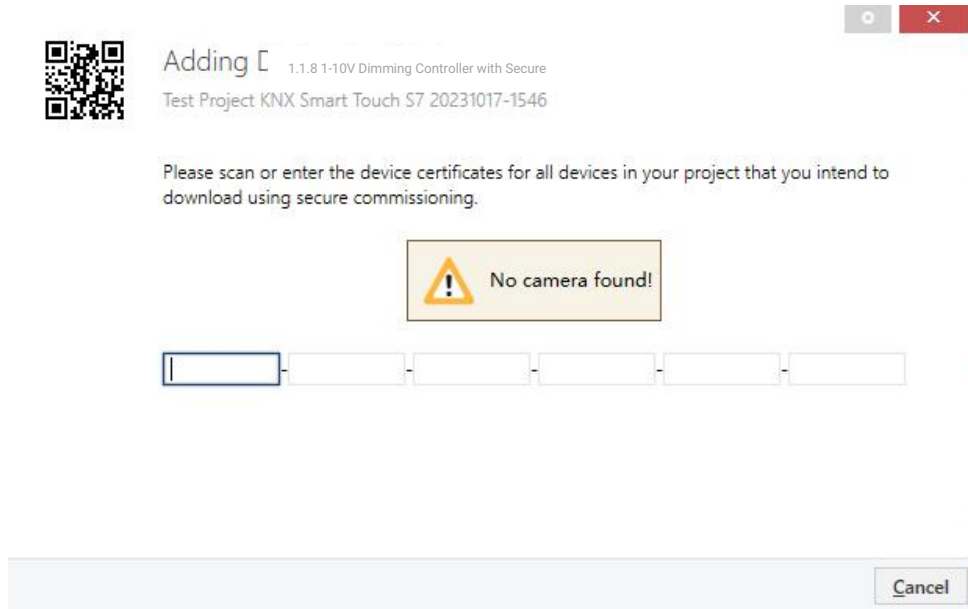

Fig.5.1(2) Add Device Certificate window

✧ Alternatively, the certificates of all Secure devices can be entered in the ETS beforehand.

This is done on the "Security" tab on the project overview page, as shown in Fig.5.1(3) below.

The certificates can be also added to the selected device in the project, as shown in

Fig.5.1(4).

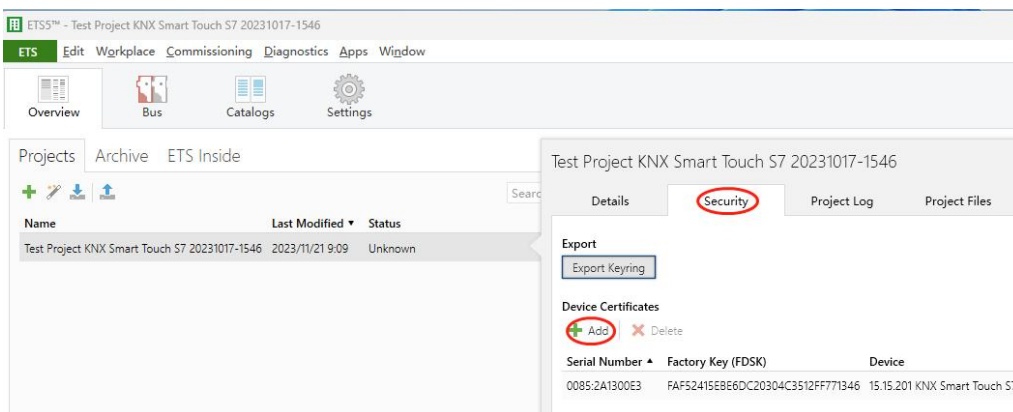

Fig.5.1(3) Add Device Certificate

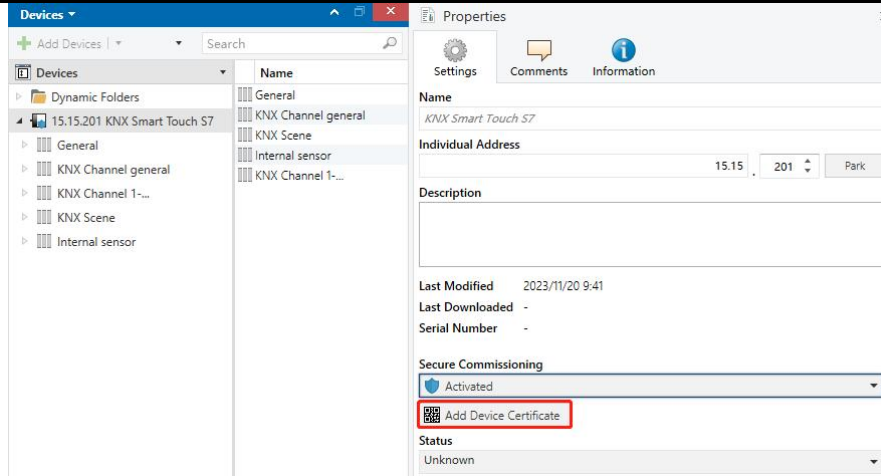

Fig.5.1(4) Add Device Certificate

✧ There is a FDSK sticker on the device, which is used for viewing FDSK number.

Without the FDSK, it will no longer be possible to operate the device in KNX Secure mode after a reset.

The FDSK is required only for initial commissioning. After entering the initial FDSK, the ETS will assign a new key, as shown in Fig.5.1(5) below.

The FDSK will be required again only if the device was reset to its factory settings (e.g. If the device is to be used in a different ETS project).

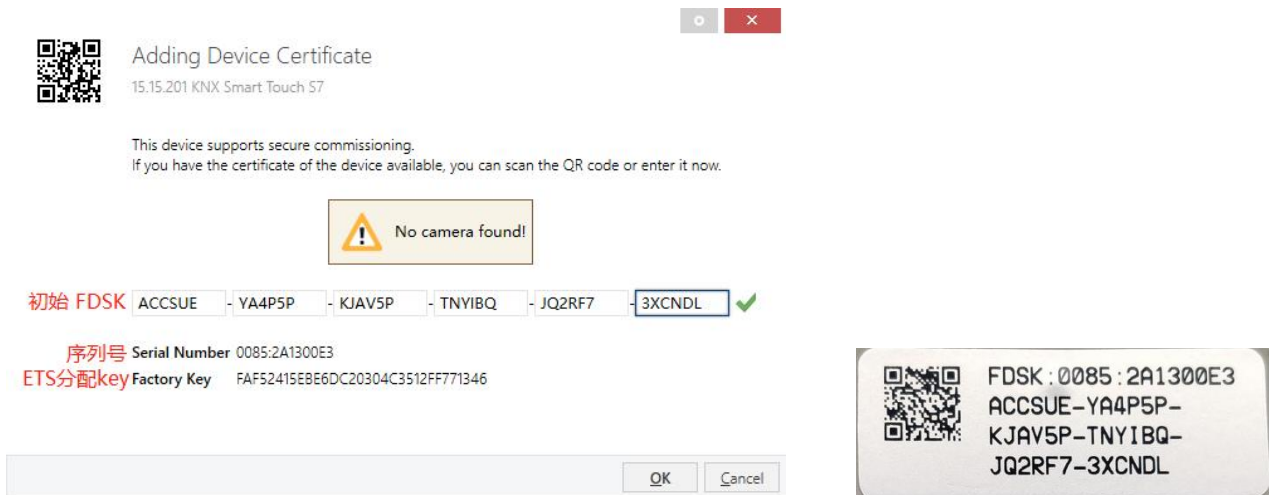

Fig.5.1(5)

Example:

If this application in the project needs to be tried with another device, it is no longer the original device. When the application is downloaded to a new device, the following prompt will appear on the left of Fig.5.1(6), click yes, the Add Device Certificate window will appear, then enter the initial FDSK of the new device, and you need to reset the device to the factory settings (it is not required if the device is still factory default; If it has been used, it will be required to reset, otherwise the following error message will appear on the right of Fig.5.1(6)), and then the device can be successfully downloaded again.

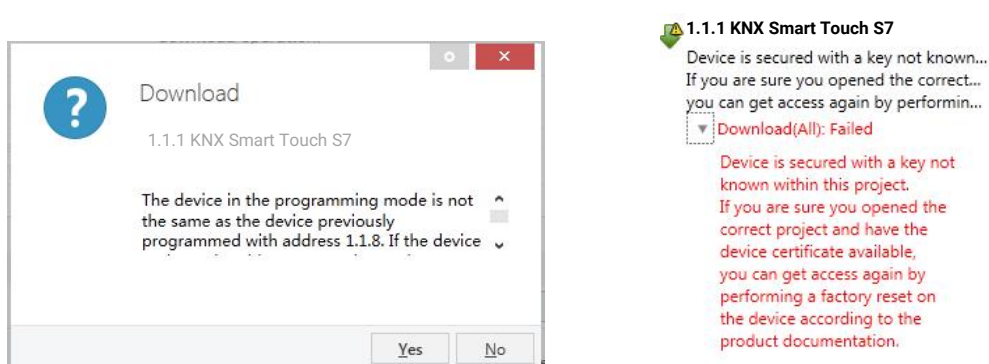

Fig.5.1(6) Example

Whether the device is replaced in the same project, or the device is replaced in a different project, the processing is similar: **Reset the device to the factory settings, then reassign the FDSK.**

After the device is downloaded successfully, the label Add Device Certificate turns gray, indicating that the key for this device has been assigned successfully, as shown in Fig.5.1(7) below.

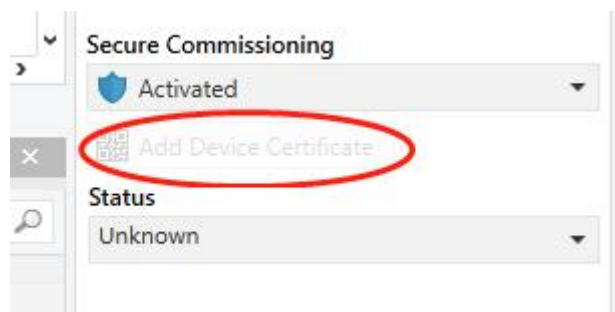

Fig.5.1(7)

ETS generates and manages keys:

Keys and passwords can be exported as needed to the use of security keys outside of the associated ETS projects. As shown in Fig.5.1(8) below, the file extension is .knxkeys.

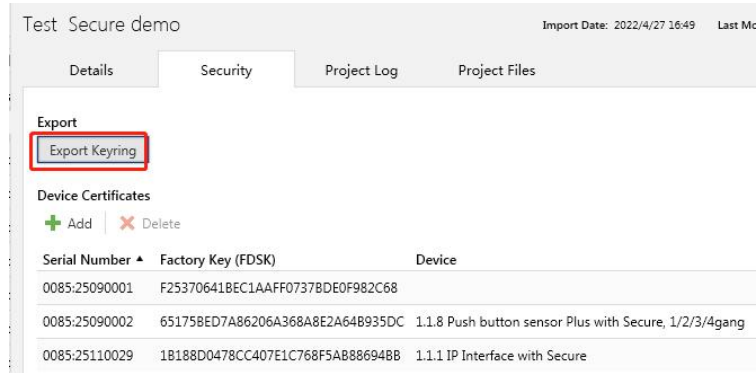

Fig.5.1(8)

Note: Any USB interface used for programming a KNX Secure device must support "long frames".

Otherwise ETS will report a download failure information, as shown below.

5.2 Parameter window “General”

5.2.1 Parameter window “General setting”

Parameter window “General setting” shown as Fig.5.2.1, it is mainly for the general setting of the device, such as password setting, day/night mode, summer time setting, proximity setting, security setting etc.

--- KNX Smart Touch S7 > General > General setting

- KNX Secure
- General
- General setting**
- Security setting
- Coordinates location setting
- Summer time setting
- Proximity setting
- Advanced setting
- Home page
- Display view
- Area 1...
- KNX Channel
- Channel 1...
- KNX Scene
- Internal sensor measurement...

Display mode: Vertical Horizontal

Send delay after voltage recovery [0..15]: 0 s

Send request delay between status objects: 100 ms

Send cycle of In operation telegram [1..240,0=inactive]: 0 s

Delay time for exiting setting status: 3.0 s

Long operation for touch after: 0.5 s

Cyclical send date and time [0..255,0=inactive]: 0 h

Delay time for back to homepage after no operation [0..255,0=inactive]: 15 s

Screen display setting

Temperature display units: Celsius(°C) Fahrenheit(°F)

Interface Language: English

Note: The codepage option in the property of project must select the Unicode(UTF-8)

UI theme is: 1

Theme preview

Date display format: yyyy/mm/dd dd/mm/yyyy

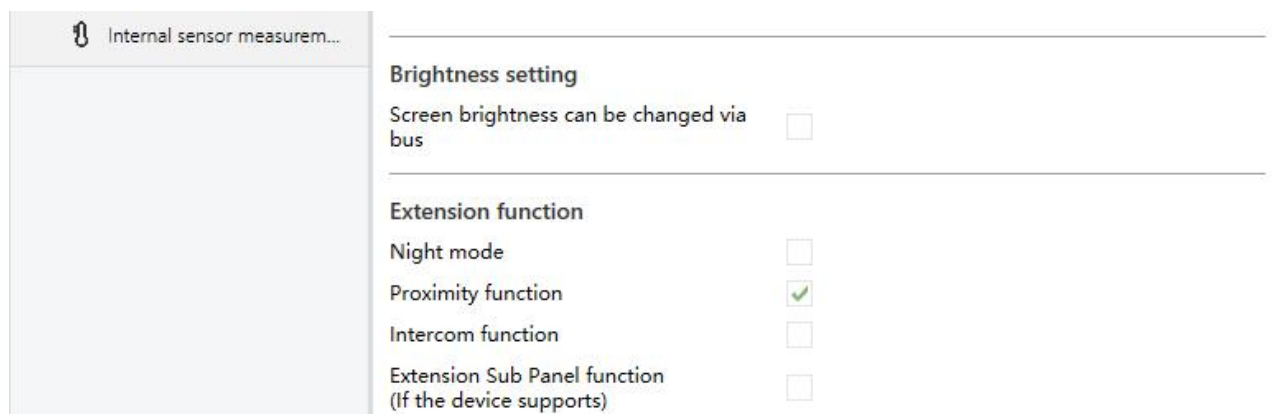

Fig.5.2.1 "General setting" parameter window

Parameter "Display mode"

This parameter is for setting the display mode of KNX Smart Touch S7, according to the installation direction of the device. Options:

Vertical

Horizontal

Parameter "Send delay after voltage recovery [0..15]s"

This parameter is for setting the delay time to send to bus after the device voltage recovery.

Options: **0..15**

The setting dose not contain the device initialization time, and bus telegrams received during delay time will be recorded.

Parameter "Send request delay between status objects"

This parameter is setting for the the delay between sending status object request telegram.

Options:

50ms

100ms

200ms

Parameter "Send cycle of In operation telegram [1..240.0=inactive]s"

This parameter is for setting the time interval when this device cycle send telegrams through the

bus to indicate this module in normal operation. When set to “0”, the object “in operation” will not send a telegram. If the setting is not “0”, the object “In operation” will send a telegram according to the set period time with logic “1” to the bus. Options: **0...240s, 0= inactive**

As to reduce the bus load as much as possible, the maximum time interval should be selected according to actual needs.

Parameter “Delay time for exiting setting status”

This parameter is for setting the delay time to auto-exit setting status, mainly used for the sub function settings of RTC, Air-condition and Audio control. Telegrams are sent immediately, such as setpoint temperature, specific definition is according to the UI. Options:

1.0s

2.0s

3.0s

4.0s

5.0s

Parameter “Long operation for touch after”

This parameter is for setting the trigger time of the long operation for touch on the screen.

Options:

0.5s

1.0s

2.0s

3.0s

Parameter “Cyclically send date and time [0...255,0=inactive]h”

This parameter is used to set the cycle for cyclically sending the date and time to the bus.

When setting to 0, it will not sent.

Options: **0...255**

Parameter “Delay time for back to homepage after no operation[0...255,0=inactive]s”

This parameter is for setting the delay time from function page back to home page when no operation on the device. Options: **0...255**

When setting to 0, it will not return to the home page automatically.

Screen display setting

Parameter "Temperature display units"

This parameter is for setting temperature display units. Options:

Celsius(°C)

Fahrenheit(°F)

Parameter "Interface Language"

This parameter is for setting interface language. Options:

Chinese(Simplified)

Spanish

Chinese(Traditional)

Russian

English

Arabic

German

Polish

French

Portuguese

Other

Displays the note when Chinese is selected:

i 警告：请务必确保工程属性里的编码页选项为UTF-8，否则中文显示将会异常

Displays the note when a non-Chinese language is selected:

i Note:The codepage option in the property of project must select the Unicode(UTF-8)

Note: For application versions below 4.1.0, the interface language only supports simplified Chinese and English.

—Parameter "Language name"

This parameter is visible when interface language is selected "Other", used for input language name. The device will search for the corresponding language in the library according to the name and display it. When no corresponding language is searched, there will be displayed English by default.

Currently, the other interface languages supported are norwegian, italian, farsi, hebrew.

Note: When select “Other” language, it is necessary to confirm with the manufacturer whether the language and the corresponding name is supported.

UTF-8 setting as shown as follow:

The screenshot shows the GVS software interface. On the left, a project list table is visible with columns for Name, Last Modified, and Status. The selected project is 'Test Project KNX Smart Touch S7 20231017-1546'. On the right, the 'Details' tab of the project configuration is open. The 'Codepage' field is set to 'Unicode (UTF-8)'.

Name	Last Modified	Status
Test Project KNX Smart Touch S7 20231017-1546	2023/11/20 14:09	Unknown

Project Details: Test Project KNX Smart Touch S7 20231017-1546

Import Date: 2023/10/18 14:43 | Last Modified: ...

Fields in Details tab:

- Name: Test Project KNX Smart Touch S7 20231017-1546
- Project Number: [Empty]
- Contract Number: [Empty]
- Password: [Masked]
- BCU Key: [Empty]
- Codepage: Unicode (UTF-8)

Parameter “UI theme is”

This parameter is for setting interface theme style of the screen, with two styles to choose from. Each style comes with a default background image. You can modify it on the screen. Options:

- 1
- 2
- 3

Parameter “Date display format”

This parameter is for setting date display style of screen. Options:

- yyyy/mm/dd**
- dd/mm/yyyy**

Brightness setting

Parameter “Screen brightness can be changed via bus”

This parameter is for setting whether to adjust screen brightness via bus. If enabled, object “Screen backlight brightness” is visible which is used to change screen brightness.

Extension function

Parameter “Night mode”

When this parameter is enabled, the “night mode” setting is visible. This function is described in detail in section 5.2.3.

Parameter "Proximity function"

When this parameter is enabled, the "Proximity function" setting is visible. This function is described in detail in section 5.2.5.

Parameter "Intercom function"

When this parameter is enabled, the "intercom function" is visible on the device side.

Parameter "Extension Sub Panel function (if the device supports)"

This parameter sets the extension Sub panel function, the setting of this part is meaningful when the device with extension sub panel.

When enabled, you can configure the brightness indication of the ambient light & button LED.

Button functions can be configured on the screen.

5.2.2 Parameter window “Security setting”

Parameter window “Security setting” shown as Fig.5.2.2, it is mainly for setting password function and the object type of output value sent to the bus after device is activated through password.



图 5.2.2 “Security setting” Parameter 设置界面

Parameter “Common password”

This parameter is for setting the common pin code, which is used to wake-up screen、arm/disarm、SOS、call forwarding、enter setting shortcut page and edit page when the device password is forgotten.

Parameter “Output object type when wake-up screen via password”

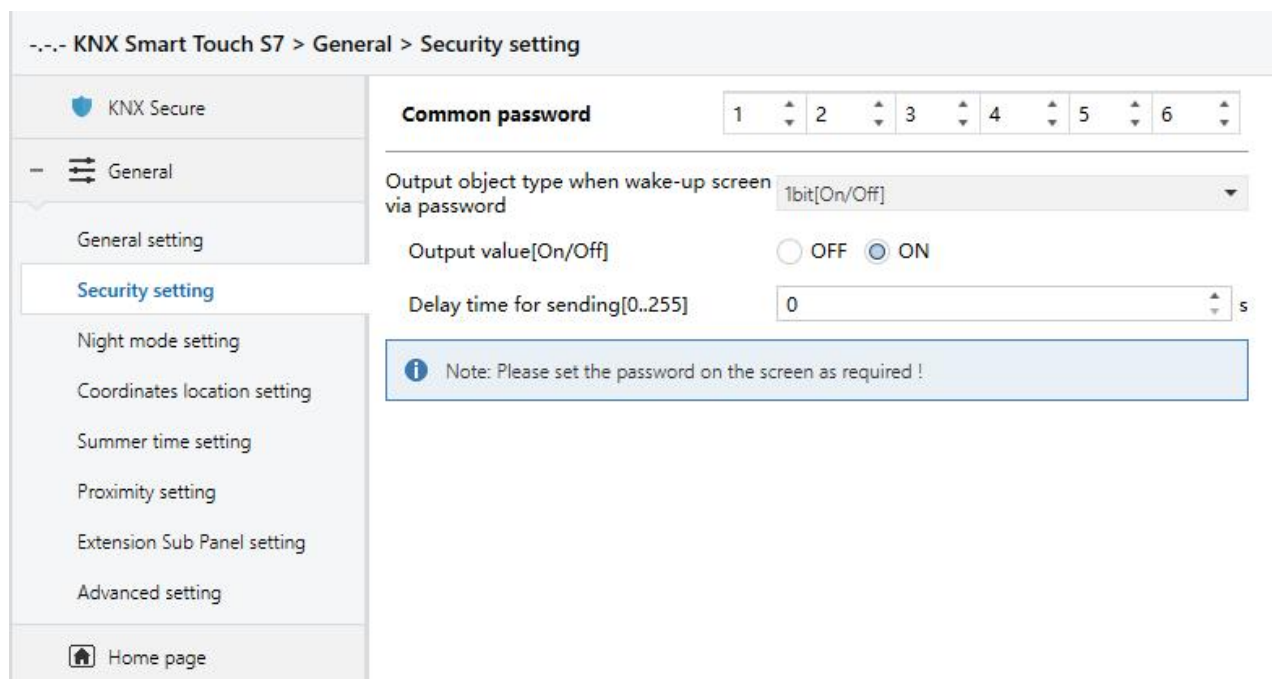
This parameter is for setting whether to send telegrams to bus when user wake-up screen via password. Options:

No reaction

1bit[On/Off]

1byte[scene control]

1byte[0..255]

1byte[0..100%]

Note:The password is set on the screen, if the password is not set on the screen, the setting here will be meaningless.

When “No reaction” is no selected, the following parameter is visible.

——Parameter“ Output value[On/Off]”

——Parameter“ Output scene NO.[1..64]”

——Parameter“ Output value[0..255]”

——Parameter“ Output value[0..100%]”

This parameter is for setting the specific sent telegram value according to previous parameter.

Options: **OFF/ON / Scene No.1..Scene No.64 / 0..255 / 0..100%**

——Parameter“Delay time for sending[0..255]s”

This parameter is for setting the delay time for sending value。 Options: **0...255**

5.2.3 Parameter window “Night mode setting”

Parameter window “Night setting” shown as Fig.5.2.3, it is mainly for set the time to switch to night or day.

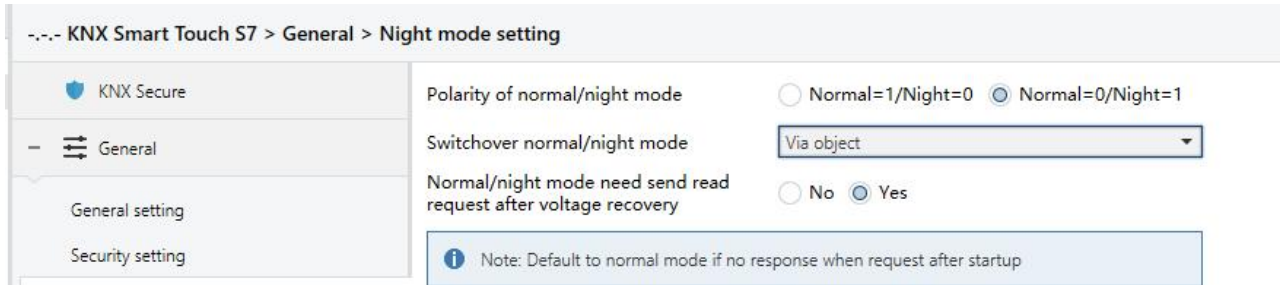

Via object

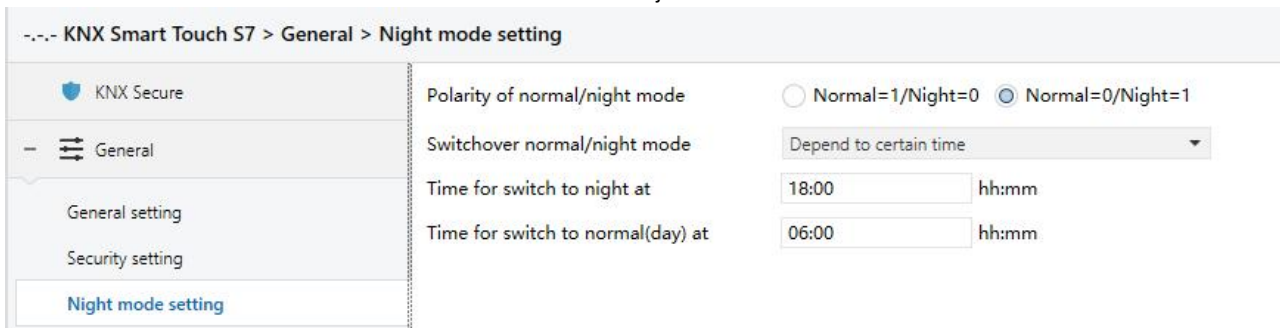

Depend to certain time

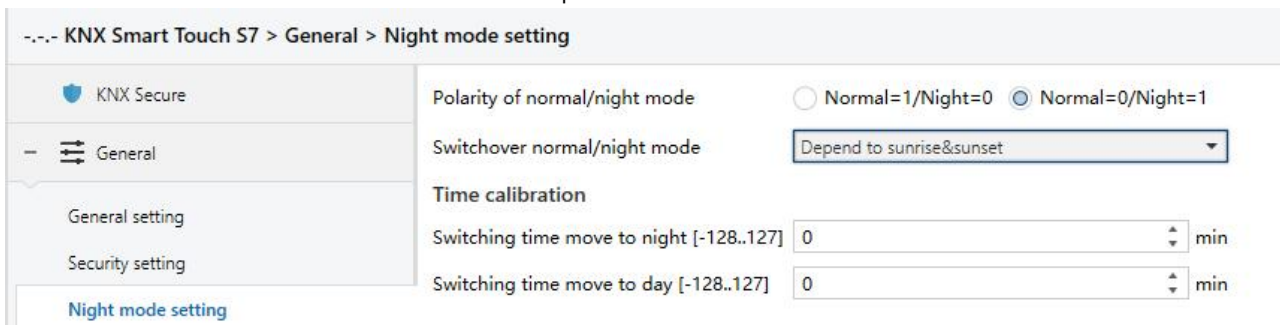

Depend to sunrise&sunset

Fig.5.2.3 “Night mode setting” parameter window

Parameter “Polarity of normal/night mode”

This parameter for setting object value of normal/night mode. Options:

Normal=1/Night=0

Normal=0/Night=1

Parameter "Switchover normal/night mode"

This parameter for setting the switchover mode of normal/night status, send status telegrams via object "Night mode" when status change. Options:

Via object

Depend to certain time

Depend to sunrise&sunset

Via object: Only switch status via object. Default to normal mode after voltage recovery.

Depend to certain time: Switch the normal/night status based on the specific time. Such as switch 18:30 PM to the night status, 6:30 AM to the normal status.

Depend to sunrise&sunset: Switch the normal/night status based on the sunrise and sunset. The coordinate position of the reference point of sunrise and sunset, such as Beijing, China, needs to be defined, with the center located at east longitude 160°20' and north latitude 39°56'.

When "Via object" is selected, the following parameter is visible, for setting the object via bus to switch to the night or to the normal.

Parameter "Normal/night mode need send read request after voltage recovery"

This parameter for setting whether the object "Night mode" to send read request when bus recovery or finish programming. If send the read request, LED indicates according to setting brightness of responded normal/night mode. Options:

No

Yes

 Note: Default to normal mode if no response when request after startup

When "Depend to certain time" is selected, the following 2 parameters are visible, for setting the time to switch to the night or to the normal.

When “Depend to certain time” is selected, the following 2 parameters are visible, for setting the time to switch to the night or to the normal.

Parameter “Time for switch to night at”

Parameter “Time for switch to normal (day) at”

This parameter for setting the time point to switch to the nigh/normal status, accurate to minutes.

Options: **00:00-23:59**

When “Depend to sunrise&sunset” is selected, the following parameters are visible, for setting the coordinate position of the reference point of sunrise and sunset.

Parameter “Switching time move to night [-128..127]min”

This parameter for setting the delay time to switch to the night status after reaching to the time point of sunset. Options: **-128..127**

Parameter “Switching time move to day [-128..127]min”

This parameter for setting the delay time to switch to the day status after reaching to the time point of sunrise. Options: **-128..127**

For example, if setting -10min, it will switch to day status 10min earlier before the sunrise; if setting 10min, it will switch to day status 10min later after the sunrise.

5.2.4 Parameter window “Coordinates location setting”

Parameter window “Coordinates location setting” shown as Fig.5.2.4, it is mainly for set the the coordinate position of the reference point of sunrise and sunset.

--- KNX Smart Touch S7 > General > Coordinates location setting

<ul style="list-style-type: none"> KNX Secure General General setting Security setting Night mode setting Coordinates location setting Summer time setting Proximity setting 	<p>Latitude longitude setting location: Beijing, China</p> <p>Latitude: <input checked="" type="radio"/> North <input type="radio"/> South</p> <p>Latitude in degrees [0..90]: 39 °</p> <p>Latitude in minutes [0..59]: 56 '</p> <p>Longitude: <input checked="" type="radio"/> East <input type="radio"/> West</p> <p>Longitude in degrees [0..180]: 116 °</p> <p>Longitude in minutes [0..59]: 20 '</p> <p>Time difference from Universal Time (UTC + ...): (UTC +08:00) Singapore, Beijing, Hong Kong, Taipei</p>
---	--

Fig.5.2.4 “Coordinates location setting” parameter window

Parameter “Latitude longitude setting location”

Setting the reference point of sunrise and sunset, such as “Beijing, China”.

Parameter “Latitude”

Setting whether the reference point of sunrise and sunset is located at south latitude or north latitude. Options:

North

South

—Parameter “Latitude in degrees [0..90]”

—Parameter “Latitude in minutes [0..59]”

These two parameters for setting latitude, such as Beijing located at north latitude 39°56'.

Parameter “Latitude”

Setting whether the base point of sunrise and sunset is located at east longitude or west longitude.

Options:

East

West

—Parameter“ Longitude in degrees [0..180]”

—Parameter“ Longitude in minutes [0..59]”

These two parameters for setting longitude, such as Beijing located at east longitude116°20'.

Parameter“ Time difference from Universal Time (UTC + ...)”

This parameter for setting the time difference from Universal Time. Options:

(UTC -12: 00) International Date Line West

(UTC -11: 00) Samoa

.....

(UTC +11: 00) Magadan, Salomon Islands, New Caledonia

(UTC +12: 00) Auckland, Wellington, Fiji

5.2.5 Parameter window "Summer time setting"

--- KNX Smart Touch S7 > General > Summer time setting

<ul style="list-style-type: none"> KNX Secure General General setting Security setting Night mode setting Coordinates location setting Summer time setting Proximity setting Extension Sub Panel setting 	<p>Summer time <input checked="" type="checkbox"/></p> <p>Start at month: March</p> <p>Start at week: The last week</p> <p>Start at day: Sunday</p> <p>Start at hour: minute: 02:00 hh:mm</p> <hr/> <p>End at month: October</p> <p>End at week: The last week</p> <p>End at day: Sunday</p> <p>End at hour: minute: 03:00 hh:mm</p>
--	--

Fig.5.2.5 "Summer time setting" parameter window

Parameter "Summer time"

This parameter is for setting whether summer time. Options:

Disable

Enable

When "Summer time" is enable, the following parameters are visible, for setting the start or end time of summer time.

---Parameter "Start at month"

---Parameter "End at month"

These parameters for setting summer time start or end at month.Options:

January

February

...

December

—Parameter“Start at week”

—Parameter“End at week”

These parameters for setting summer time start or end at week. Options:

The first week

The second week

...

The last week

—Parameter“Start at day”

—Parameter“End at day”

These parameters for setting summer time start or end at day. Options:

Monday

Tuesday

...

Sunday

—Parameter“Start at hour:minute”

—Parameter“End at hour:minute”

These parameters for setting summer time start or end time, accurate to minutes. Options:

00:00-23:59

Take American time for example, setting summer time start from 02h: 00min, the second Sunday of March to 02h: 00min, the first Sunday of November each year, so during this summer time, when it comes to the start time, system default time will be an hour faster, displayed time on the device will be 03h: 00min; when it comes to the end time, system default time will be an hour slower, displayed time on the device will be 02h:00min.

The start date and the end date cannot be the same. That is, if you set the same month, week, and day, it will be ignored and recovered to default. If only the month and week are set to the same will also be ignored.

5.2.6 Parameter window “Proximity setting”

Parameter window “Proximity setting” as shown as Fig.5.2.6. It is mainly setting proximity function, which can set the telegram when proximity approaching, and the delay time for sending telegram.

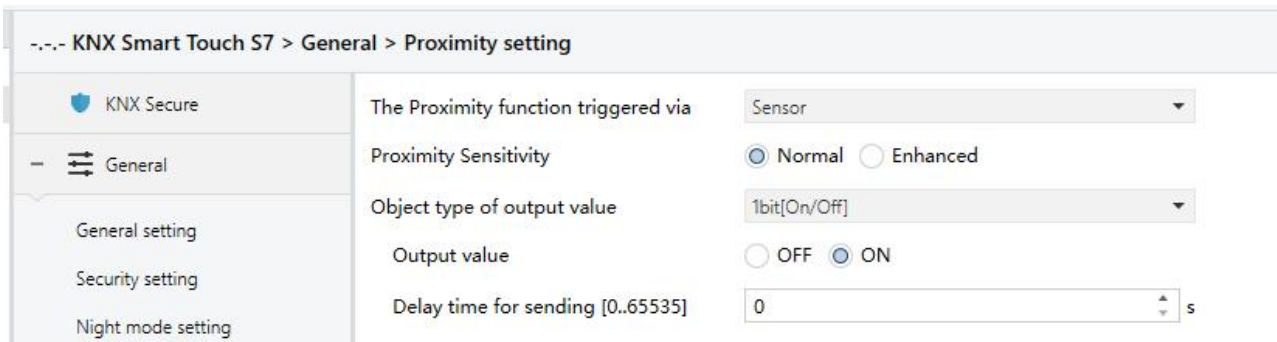

Fig.5.2.6 “Proximity setting” parameter window

Parameter “The Proximity function triggered via”

This parameter is for setting the trigger source of proximity function. Options:

Sensor

Proximity object

Sensor or Proximity object

When “Sensor or Proximity object” is selected, not send output value when proximity triggered via object.

Parameters as follow are visible when “Sensor” or “Sensor or Proximity object” is selected.

Parameter “Proximity Sensitivity”

This parameter is for setting the sensitivity of proximity sensing. Normal sensing distance is 30cm, enhanced sensing distance is 60cm.

Options:

Normal

Enhanced

Parameter "Object type of output value"

This parameter is for setting the object type of output value to the bus when proximity approaching. Options:

1bit[On/Off]

1byte [scene control]

1byte[0..255]

1byte[0..100%]

——Parameter "Output value[On/Off]"

——Parameter "Output scene NO.[1..64]"

——Parameter "Output value[0..255]"

——Parameter "Output value[0..100%]"

These parameters are set the output value sending to the bus when proximity approaching, the range of value is determined by the data type.

——Parameter "Delay time for sending[0..65535]"

This parameter is set the delay time for sending telegram.

When proximity approaching, Options: **0..65535**

Note: Multiple departures from close proximity during the delay time will not repeat the message.

5.2.7 Parameter window "Extension Sub Panel setting"

This parameter window is visible when the "Extension Sub Panel function (If the device supports)" parameter is selected as enabled in Fig.5.2.7 "Extension function".

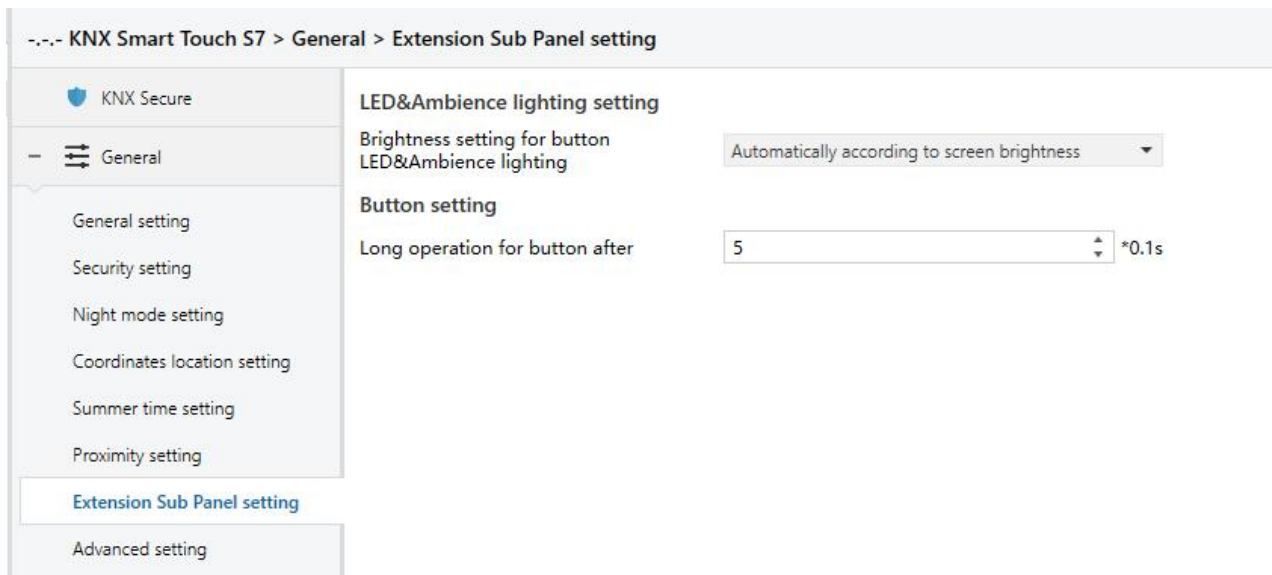

Fig.5.2.7 "Extension Sub Panel setting" parameter window

LED&Ambience lighting setting

Parameter "Brightness setting for button LED&Ambience lighting"

This parameter sets the brightness of the LED and ambient lights in the button. Options:

None

According to parameter

Automatically according to screen brightness

According to parameter: Display brightness according to ETS settings.

Automatically according to screen brightness: The maximum brightness of the buttons and ambient light follows the screen brightness.

The following parameters are visible when selecting "According to parameter".

—Parameter“LED brightness in normal mode”

This parameter is for setting the LED brightness when normal or day mode . Options: **0...100%**

—Parameter“LED brightness in night mode”

This parameter is visible when night mode enabled. Set the LED brightness when night mode.

Options:

0...100%

—Parameter“Ambience lighting brightness in normal mode”

This parameter is for setting the Ambience lighting brightness when normal or day mode . 可选项:

0...100%

—Parameter“Ambience lighting brightness in night mode”

This parameter is visible when night mode enabled. Set the Ambience lighting brightness when night mode. Options:

0...100%

—Parameter“LED brightness in standby mode”

The parameter is setting the brightness of the LED in standby mode. Optional: **0...50%**

—Parameter“Ambience lighting brightness in standby mode”

The parameter is setting the brightness of the Ambience lighting in standby mode.

Optional:**0...50%**

Button setting**Parameter“Long operation for button after ”**

This parameter is setting long operation for button after.

5.2.8 Parameter window “Advanced setting”

Parameter window “Advanced setting” shown as Fig.5.2.8.Used to enable HVAC controller, human-centric lighting(HCL) , schedule function, alarm function, and scene group function.More details refer to chapter 5.3-5.8.

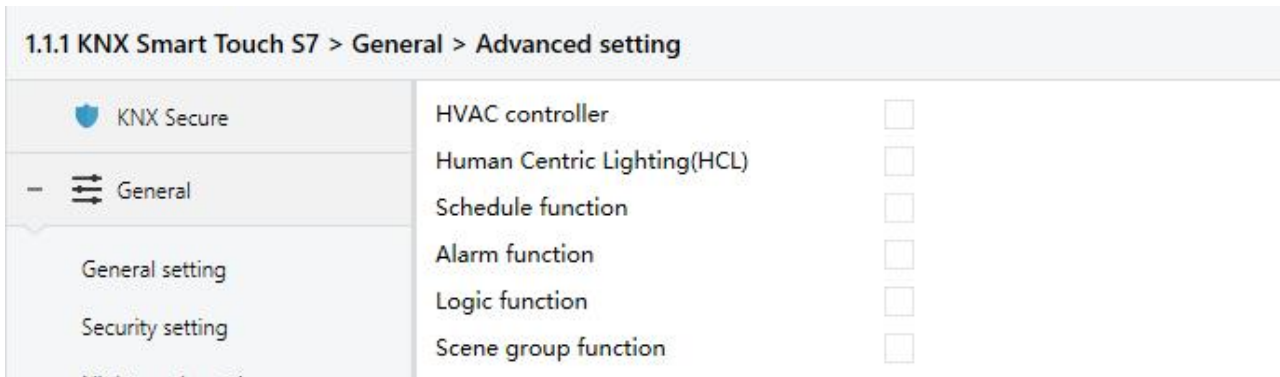

Fig.5.2.8 “Advanced setting” parameter window

5.3 Parameter window “HVAC controller”

The parameter “HVAC controller” is visible when enabled in the “Advanced setting” interface shown in Figure 5.2.8, as shown in Figure 5.3.



Fig.5.3 “HVAC controller” parameter window

Parameter: Number of controllers (max.6)

This parameter sets the number of controllers.Options:1-6

5.3.1 Parameter window "Controller x-Room temperature controller(RTC)"(x=1~6)

This parameter window is visible when "Room temperature controller(RTC)" is selected as the controller type,as shown in Fig.5.3.1.

--- KNX Smart Touch S7 > HVAC controller > Controller 1...

KNX Secure

General

- General setting
- Security setting
- Night mode setting
- Coordinates location setting
- Proximity setting
- N accessory setting
- Advanced setting

Home page

+ Display view

+ KNX Channel

+ KNX Scene

Internal temperature measurement

- HVAC controller

- Controller 1...

Description (max 30char.)

Controller type

- Room temperature controller (RTC)
- Ventilation controller

Room temperature reference from

Internal sensor

Control value after temp. error[0..100]
(if 2-point control, set value '0'=0, set value '>0'=1)

0 %

Room temperature control mode

Heating

Operation mode

Controller status after download

Comfort mode

Controller status after voltage recovery

As before voltage failure

Extended comfort mode
[0..255,0=inactive]

0 min

1 bit object function for operation mode

1 bit object for standby mode

Fan speed auto.control function

Window contact input function

Delay for window contact [0..65535]

15 s

Controller mode for open window

- Economy mode
- Frost/heat protection

Bus presence detector function

Fig.5.3.1 "Controller x-Room temperature controller(RTC)"(x=1~6) parameter window

Parameter "Description (max 30char.)"

This parameter is for setting the name description for controller x,up to input 30 characters.

Parameter "Controller type"

This parameter is for setting the controller type.Options:

Room temperature controller (RTC)

Ventilation controller

Parameter "Room temperature reference from"

This parameter is for setting the resource of the RTC function temperature reference. Options:

Internal sensor

External sensor

Internal and External sensor combination

When selecting the reference internal sensor, the temperature is determined by the setting of the “Internal sensor” in the parameter interface, more details refer to chapter 5.13.

Parameters as follow are visible when “Internal sensor combine with External sensor” is selected.

——Parameter“Combination ratio”

This parameter is for setting the internal sensor and the external sensor to measure the specific gravity of the temperature. Options:

10% Internal to 90% External

20% Internal to 80% External

...

90% Internal to 10% External

For example, if the option is “40% internal to 60% external”, then the internal sensor accounts for 40%, the external sensor accounts for 60%, and the control temperature = (internal sensor's temperature × 40%) + (external sensor's temperature × 60%), the RTC function of the device will control and display the temperature according to the calculated temperature.

When two sensors are combined for detection, when one sensor is in error, the temperature value detected by the other sensor is used.

——Parameter“Period for request external sensor [0...255,0=inactive]min”

This parameter is for setting the time period for read request external temperature sensor. Options:

0..255

——Parameter“Send temperature when the result change by [0...10]K”

This parameter is for setting when temperature turns to a certain value, whether to enable to send the current temperature value to the bus. Not send when disable. Options:

Disable

0.5K

1.0K

...

10K

—Parameter“Cyclically send temperature [0...255,0=inactive]min”

Setting the time for cyclically sending the temperature detection value to the bus. Not send when value is 0.

Options: **0..255**

Parameter“Control value after temp. error [0..100]%(if 2-point control, set value '0'=0, set value '>0'=1)”

This parameter is for setting the control value when temperature error occur. Options: **0..100**

If 2-Point control, then the parameter value is 0, as well as the control value; if the parameter value is more than 0, then the control value will be 1.

Parameter“Room temperature control mode”

This parameter is for setting room temperature control mode. Options:

Heating

Cooling

Heating and Cooling

Parameters as follow are visible when “Heating and Cooling” is selected

—Parameter“Heating/Cooling switchover”

This parameter is for setting the switchover way of Heating/Cooling. Options:

Via object

Automatic changeover**—Parameter“Heating/Cooling status after download”**

This parameter is for setting the heating/cooling control mode of device when power on RTC after download. Options:

Heating

Cooling

—Parameter“Heating/Cooling status after voltage recovery”

This parameter is for setting the heating/cooling control mode of device when power on RTC after voltage recovery. Options:

Heating

Cooling

As before voltage failure

As before voltage failure: When the device is reset after power on, the control mode will recover as before voltage failure. If it is the first time the device is used or a newly enabled device function, the control mode after the device is started is in an uncertain state, and it needs to be manually selected at this time.

—Parameter“ Room temperature control system”

This parameter is for setting the type of RTC control system, that is, pipe types of fan coil water inlet/outlet. Options:

2 pipes system

4 pipes system

2 pipes system: Shares an inlet and outlet pipe for heating and cooling, that is, both hot and cold water are controlled by a valve.

4 pipes system: Has its own inlet and outlet pipes for heating and cooling, and two valves are needed to control the entry and exit of hot water and cold water respectively.

Parameter "Operation mode"

This parameter is for setting whether to enable RTC operation mode.

Parameters as follow are visible when operation mode disabled.

---Parameter "Initial setpoint temperature"

This parameter is for setting the initial value of setpoint temperature. Options:

10.0

10.5

...

35.0

---Parameter "Min./Max. setpoint temperature [5..37]"

This parameter is for setting limit the adjustable range of the setpoint temperature, the minimum value should be less than the maximum value. If the setpoint temperature beyond the limited range, the will output the limited temperature. Options:

5°C

6°C

37°C

Parameters as follow are visible when "Heating/Cooling switchover" and "Automatic changeover" is selected.

---Parameter "Upper /Lower dead zone"

This parameter is fot setting the dead zone range of auto switchover heating/cooling. Options:

0.5K

1.0K

...

10.0K

Under heating control, when the actual temperature(T) > or = the setpoint temperature + the upper dead zone, then mode heating switch to cooling;

Under cooling control, when the actual temperature(T) < or = the setpoint temperature + the upper dead zone, then mode cooling switch to heating.

Parameters as follow are visible when operation mode enabled.

——Parameter“ Controller status after download”

This parameter is for setting the operation mode when power on RTC after download. Options:

Standby mode

Comfort mode

Economy mode

——Parameter“Controller status after voltage recovery ”

This parameter is for setting the operation mode when power on RTC after voltage recovery.

Options:

Comfort mode

Standby mode

Economy mode

Frost/heat protection

As before voltage failure

——Parameter“Extended comfort mode [0..255,0=inactive] min”

This parameter is for setting the extended time of comfort mode. When value >0, activate the extended, and 1 bit object “Extended comfort mode” is visible. Options: **0..255**

When object receives telegram 1, comfort mode activation. If receive telegram 1 again during the delay time, the time is retiming. And comfort mode will return to previous operation mode once finish the timing. Exit the comfort mode when a new operation mode in delay time.

Switch operation will quit the timing, and heating/cooling switchover will not.

——Parameter“1 bit object function for operation mode”

This parameter is for setting whether to enable 1 bit objects of operation mode are visible.

Corresponding mode activation when objects send telegram 1; Perform standby mode when object values of comfort, economy, protection received from the bus are 0.

—Parameter“1 bit object for standby mode”

This parameter is visible when previous parameter enabled. Set whether to enable 1 bit object of standby mode is visible.

Parameter“Fan speed auto control function”

This parameter is for setting whether to enable fan auto control interface is visible.

Parameter“Window contact input function”

This parameter is visible when RTC operation mode enabled. Set whether to link to window contact status.

Parameters as follow are visible when“Window contact input function” enabled.

—Parameter“Delay for window contact [0..65535]s”

This parameter is visible when RTC operation mode and window contact input function are enabled. Set the delay time to window contact detection. That is, when the window is open within the set value, the window is not open. If the time is out of the set value, the window is open. Options:

0..65535

—Parameter“Controller mode for open window”

This parameter is visible when RTC operation mode and window contact input function are enabled. If window status is open, perform corresponding operation according to configuration. (For the operation mode, the Switch and Setpoint temperature, as well as Heating/Cooling mode are recorded in the background if a control telegram is received, and performed after the window is closed. If no logging is received, return to the mode before the window was opened.) Options:

Economy mode

Frost/heat protection

Parameter“Bus presence detector function”

This parameter is visible when RTC operation mode enabled. Set whether to link to bus presence detector status.

If presence is detected, enter the comfort mode and recovery original mode after leaving. If there is a telegram/manual to adjust the mode, it will not recovery the previous mode after leaving. (If receive presence status cyclically, no comfort mode retriggered, and only can be after leaving.)

5.3.1.1 Parameter window "Setpoint"

This parameter window is visible when "Room temperature controller(RTC)" is selected as the controller type and is displayed according to the control mode,as shown in Fig.5.3.1.1.

15.15.201 KNX Smart Touch S7 > HVAC controller > Controller 1-... > Setpoint

<ul style="list-style-type: none"> Advanced setting Home page Display view KNX Channel <ul style="list-style-type: none"> Channel 1-... KNX Scene Internal temperature meas... HVAC controller <ul style="list-style-type: none"> Controller 1-... <ul style="list-style-type: none"> Setpoint Heating/Cooling control Fan auto.control Human Centric Lighting(H... Weekly timer function Alarm function <ul style="list-style-type: none"> Alarm 1-... Alarm 2-... Alarm 3-... 	<p>Setpoint method for operating mode <input checked="" type="radio"/> Relative <input type="radio"/> Absolute</p> <p>Base setpoint temperature <input type="text" value="20.0"/> °C</p> <p>Additional setpoint offset for setpoint adjustment <input type="radio"/> Disable <input checked="" type="radio"/> Enable</p> <p>Step of setpoint offset <input checked="" type="radio"/> 0.5K <input type="radio"/> 1K</p> <p>Min. setpoint offset [-10..0] <input type="text" value="-5"/> K</p> <p>Max. setpoint offset [0..10] <input type="text" value="5"/> K</p> <p>Automatic H/C mode changeover dead zone (only for comfort mode)</p> <p>Upper dead zone <input type="text" value="2.0"/> K</p> <p>Lower dead zone <input type="text" value="2.0"/> K</p> <hr/> <p>Heating</p> <p>Reduced heating in standby mode [0..10] <input type="text" value="2"/> K</p> <p>Reduced heating in economy mode [0..10] <input type="text" value="4"/> K</p> <p>Setpoint temperature in frost protection mode [5..10] <input type="text" value="7"/> °C</p> <p>Cooling</p> <p>Increased cooling in standby mode [0..10] <input type="text" value="2"/> K</p> <p>Increased cooling in economy mode [0..10] <input type="text" value="4"/> K</p> <p>Setpoint temperature in heat protection mode [30..37] <input type="text" value="35"/> °C</p> <hr/> <p>Min. setpoint temperature [5..37] <input type="text" value="10"/> °C</p> <p>Max. setpoint temperature [5..37] <input type="text" value="32"/> °C</p>
--	---

Relative

15.15.201 KNX Smart Touch S7 > HVAC controller > Controller 1-... > Setpoint

Advanced setting

Home page

+ Display view

- KNX Channel

Channel 1-...

+ KNX Scene

Internal temperature meas...

- HVAC controller

- Controller 1-...

Setpoint

Heating/Cooling control

Fan auto.control

Human Centric Lighting(H...

+ Weekly timer function

Setpoint method for operating mode Relative Absolute

Heating

Setpoint temperature in comfort mode [5..37] 21 °C

Setpoint temperature in standby mode [5..37] 19 °C

Setpoint temperature in economy mode [5..37] 17 °C

Setpoint temperature in frost protection mode [5..10] 7 °C

Cooling

Setpoint temperature in comfort mode [5..37] 23 °C

Setpoint temperature in standby mode [5..37] 25 °C

Setpoint temperature in economy mode [5..37] 27 °C

Setpoint temperature in heat protection mode [30..37] 35 °C

Note: The heating setpoint must be always less than the cooling setpoint.

Min. setpoint temperature [5..37] 10 °C

Max. setpoint temperature [5..37] 32 °C

Absolute

Fig.5.3.1.1 "Setpoint" parameter window

Parameter "Setpoint method for operating mode"

This parameter is for setting the setpoint method for operating mode. Options:

Relative

Absolute

Relative: Relative adjustment, the setting temperature of economy mode and standby mode will refer to the defined temperature setpoint.

Absolute: Absolute adjustment, each mode has its independent temperature setpoint.

Parameters as follow are visible when the setpoint temperature adopts the relative adjustment

method.**Parameter "Base setpoint temperature"**

This parameter is for setting the basic setpoint temperature, from which the initial setpoint temperature of the room comfort mode is obtained. Options:

10.0

10.5

...

35.0

The setpoint value will be modified through object "Base setpoint adjustment", then the new value will be stored after the device power off.

Current basic setpoint temperature = modified basic setpoint temperature +/- accumulated offset(if existence)

When adjusting the setpoint temperature of current operation mode, the setpoint value will be changed with it, but the relative temperature of each mode is unchanged. Relative temperature of standby, economy and comfort mode is set by the parameters as follows.

Parameter "Additional setpoint offset for setpoint adjustment"

This parameter is for setting whether to enable additional setpoint offset function for setpoint adjustment, mainly used to adjust setpoint temperature by 1 bit object. Options:

Disable

Enable

Increase/decrease offset by 1 bit object "Setpoint offset", adjust the setpoint temperature indirectly, and send offset value to the bus by 2 byte object "Float offset value". Also reset the offset value by 1 bit object "Setpoint offset reset", modified the offset value by 2 byte object "Float offset value". Save the offset value when control mode and operation mode changed.

Parameters as follow are visible when "Additional setpoint offset for setpoint adjustment" enabled.

—Parameter“Step of setpoint offset”

This parameter is for setting step value of setpoint offset increased/decreased when receiving telegrams. Telegram 1- increase, telegram 0- decrease. Accumulated offset can be saved when power off. Options:

0.5K

1K

Setpoint temperature of current mode = base temperature + fix offset of mode + accumulated additional offset

Note: Fix offset of mode is the offset of standby and economy modes compared to comfort mode, which is decided by the follow parameters of heating/cooling. Accumulated additional offset is adjusted by 1bit object “Setpoint offset”, or directly modified the offset value by 2 byte object “Float offset value”.

—Parameter“Min. setpoint offset [-10..0]K”

This parameter is for setting the maximum offset allowed when negative offset (setpoint temperature is decreased). Options: **-10..0**

—Parameter“Max. setpoint offset [0..10]K”

This parameter is for setting the maximum offset allowed when forward offset (setpoint temperature is increased). Options: **0..10**

Automatic H/C mode changeover dead zone (only for comfort mode)**Parameter“Upper/Lower dead zone ”**

These two parameters are visible when control mode “Heating and Cooling” is selected, and “Automatic changeover” is selected. Setting the dead zone range of auto switchover heating/cooling.

Options:

0.5K

1.0K

...

10K

Under heating control, when the actual temperature(T) > or = the setpoint temperature + the upper dead zone, then mode heating switch to cooling;

Under cooling control, when the actual temperature(T) < or = the setpoint temperature + the upper dead zone, then mode cooling switch to heating.

Parameter "Reduced heating in standby mode [0...10]K"

Parameter "Increased cooling in standby mode [0...10]K"

These two parameters are for setting the setpoint of standby mode. Options:

0K**1K**

...

10K

Heating: The setpoint of standby mode is the temperature setpoint minus the reference value.

Cooling: The setpoint of standby mode is the temperature setpoint plus the reference value.

Parameter "Reduced heating in economy mode [0...10]K"

Parameter "Increased cooling in economy mode [0...10]K"

These two parameters are for setting the setpoint of economy mode. Options:

0K**1K**

...

10K

Heating: The setpoint of economy mode is the temperature setpoint minus the reference value;

Cooling: The setpoint of economy mode is the temperature setpoint plus the reference value.

Parameter "Setpoint temperature in frost protection mode [5...10]°C"

This parameter is for setting the setpoint of frost protection mode. Options:

5°C

6°C

...

10°C

Under the frost protection mode, when room temperature reduce to the setpoint, the controller will trigger a control telegram so that related heating controller will output heating control to prevent the temperature from being too low.

Parameter "Setpoint temperature in heat protection mode [30...37]°C"

This parameter is for setting the setpoint of heat protection mode. Options:

30°C

31°C

...

37°C

Under the heat protection mode, when room temperature raise to the setpoint, the controller will trigger a control telegram so that related cooling controller will output cooling control to prevent the temperature from being too high.

Parameters as follow are visible when the setpoint temperature adopts the absolute adjustment method.

Parameter "Setpoint temperature in comfort [5...37]°C"

Parameter "Setpoint temperature in standby mode [5...37]°C"

Parameter "Setpoint temperature in economy mode [5...37]°C"

These parameters are for setting the setpoint temperature in comfort, standby and economy mode when heating or cooling. Options:

5°C

6°C

...

37°C

Parameter "Setpoint temperature in frost protection mode [5...10] "

This parameter is for setting the setpoint temperature in frost protection mode when heating.

Options:

5°C

6°C

...

10°C

Parameter "Setpoint temperature in heat protection mode [30...37] "

This parameter is for setting the setpoint temperature in heat protection mode when cooling.

Options:

30°C

31°C

...

37°C

 Note: The heating setpoint must be always less than the cooling setpoint.

For absolute adjustment mode, "Heating and Cooling" and "Automatic changeover" are selected, the note is visible. The heating setpoint value must be less than or equal to the cooling of the same operation mode, if not, it can not be configured on ETS. It is also applied to "Via object"

1. When the ambient temperature is higher than the setpoint temperature of current mode, it is changed to cooling mode; When the ambient temperature is lower than the setpoint temperature of current mode, it is changed to heating mode.

2. In the same operation mode, the setpoint temperature difference between cooling and heating remains constant, whether it is written from the bus or adjusted on the panel. That is, when adjust the setpoint temperature, it need to update cooling and heating setpoint temperature

of current operation mode at the same time.

3. For the abnormal configuration where the heating setpoint value is greater than the cooling, it is depend on the setpoint temperature and ambient temperature to adjust heating/cooling mode, that is, change to cooling when ambient temperature is higher than the setpoint temperature in the current operation mode of cooling, while change to heating when ambient temperature is lower than the setpoint temperature in the current operation mode of cooling.

4. When receiving setpoint temperature from bus, it is still necessary to limit the value according to the high and low thresholds, that is heating and cooling temperature neither can not be lower than the min., or can not be higher than the max..

Points 2 and 4 also apply to "Via object".

Note: for relative/absolute adjustment, in protection mode, the setpoint temperature is only configured via ETS. When the received setpoint value from bus is different from the ETS configuration, the value is not updated and returned to the current setpoint temperature, to update synchronously to other devices on the bus.

5.3.1.2 Parameter window "Heating control/Cooling control/Heating/Cooling control"

This parameter window is visible when "Room temperature controller(RTC)" is selected as the controller type and is displayed according to the control mode,as shown in Fig.5.3.1.2.

15.15.201 KNX Smart Touch S7 > HVAC controller > Controller 1-... > Heating/Cooling control

<p>KNX Secure</p> <p>General</p> <p>General setting</p> <p>Security setting</p> <p>Night mode setting</p> <p>Coordinates location setting</p> <p>Summer time setting</p> <p>Proximity setting</p> <p>Extension Sub Panel setting</p> <p>Advanced setting</p> <p>Home page</p> <p>Display view</p> <p>KNX Channel</p> <p>KNX Scene</p> <p>Internal temperature meas...</p> <p>HVAC controller</p>	Type of heating/cooling control	Switching on/off(use 2-point control)		
	Invert control value	<input checked="" type="checkbox"/>		
	Heating			
	Lower Hysteresis [0..200]	10	*0.1K	
	Upper Hysteresis [0..200]	10	*0.1K	
	Cooling			
	Lower Hysteresis [0..200]	10	*0.1K	
	Upper Hysteresis [0..200]	10	*0.1K	
	Cyclically send control value [0..255]	10	min	
	<hr/>			
	Additional heating/cooling	<input checked="" type="checkbox"/>		
	Control type	<input type="radio"/> 1bit <input checked="" type="radio"/> 1byte		
	Invert control value	<input checked="" type="checkbox"/>		
	Temperature difference to switch on additional heating [-100..-5]	-25	*0.1K	
	Hysteresis to switch off additional heating [-20..-1]	-5	*0.1K	
Temperature difference to switch on additional cooling [5..100]	25	*0.1K		
Hysteresis to switch off additional cooling [1..20]	5	*0.1K		
Cyclically send control value [0..255]	0	min		

Switching on/off(use 2-point control)

15.15.201 KNX Smart Touch S7 > HVAC controller > Controller 1-... > Heating/Cooling control

<ul style="list-style-type: none"> KNX Secure General <ul style="list-style-type: none"> General setting Security setting Night mode setting Coordinates location setting Summer time setting Proximity setting Extension Sub Panel setting Advanced setting Home page Display view KNX Channel KNX Scene 	Type of heating/cooling control	Switching PWM(use PI control)	
	Invert control value	<input checked="" type="checkbox"/>	
	PWM cycle time [1..255]	15 min	
	Heating speed	Hot water heating(5K/150min)	
	Cooling speed	Cooling ceiling (5K/240min)	
	Cyclically send control value [0..255]	10 min	
	Additional heating/cooling		<input checked="" type="checkbox"/>
	Control type	<input type="radio"/> 1bit <input checked="" type="radio"/> 1byte	
	Invert control value	<input checked="" type="checkbox"/>	
	Temperature difference to switch on additional heating [-100..-5]	-25 *0.1K	
	Hysteresis to switch off additional heating [-20..-1]	-5 *0.1K	
	Temperature difference to switch on additional cooling [5..100]	25 *0.1K	
	Hysteresis to switch off additional cooling [1..20]	5 *0.1K	
	Cyclically send control value [0..255]	0 min	

Switching PWM(use PI control)

15.15.201 KNX Smart Touch S7 > HVAC controller > Controller 1-... > Heating/Cooling control

<ul style="list-style-type: none"> KNX Secure General <ul style="list-style-type: none"> General setting Security setting Night mode setting Coordinates location setting Summer time setting Proximity setting Extension Sub Panel setting Advanced setting Home page Display view KNX Channel KNX Scene 	Type of heating/cooling control	Continuous control(use PI control)	
	Invert control value	<input checked="" type="checkbox"/>	
	Heating speed	Hot water heating(5K/150min)	
	Cooling speed	Cooling ceiling (5K/240min)	
	Send control value on change by [0..100,0=inactive]	5 %	
	Cyclically send control value [0..255]	10 min	
	Additional heating/cooling		<input checked="" type="checkbox"/>
	Control type	<input type="radio"/> 1bit <input checked="" type="radio"/> 1byte	
	Invert control value	<input checked="" type="checkbox"/>	
	Temperature difference to switch on additional heating [-100..-5]	-25 *0.1K	
	Hysteresis to switch off additional heating [-20..-1]	-5 *0.1K	
	Temperature difference to switch on additional cooling [5..100]	25 *0.1K	
	Hysteresis to switch off additional cooling [1..20]	5 *0.1K	
	Cyclically send control value [0..255]	0 min	

Continuous control(use PI control)

Fig.5.3.1.2"Heating control/Cooling control/Heating/Cooling control" parameter window

Parameters of this window display according to control mode and control system(2 pipe or 4pipe).

Parameter "Type of heating/cooling control"

This parameter is visible when selecting "Heating and Cooling & 2-pipe" option, setting the type of heating/cooling control. Different control types are suitable for controlling different temperature controllers. Options:

Switching on/off(use 2-point control)

Switching PWM(use PI control)

Continuous control(use PI control)

Parameter "Invert control value"

This parameter is for setting whether to invert control value or normal sending control value, so that the control value will be suitable for the valve type. Options:

No

Yes

Yes: Sending the control value to the bus through objects after inverting the control value.

Two parameters as follow are suitable for 2 point control:

Parameter "Lower Hysteresis [0...200]*0.1K"

Parameter "Upper Hysteresis [0...200]*0.1K"

These two parameters are for setting the lower/upper hysteresis temperature in HVAC heating or cooling. Options: **0..200**

Under heating control,

When the actual temperature(T) > the setting temperature + the upper hysteresis temperature, then will stop heating;

When the actual temperature(T) < the setting temperature - the lower hysteresis temperature, then will start heating.

For example, the lower hysteresis temperature is 1K, the upper hysteresis temperature is 2K, the setting temperature is 22°C, if T is higher than 24°C, then it will stop heating; if T is lower than 24°C, then

it will start heating; if T is between 21~24°C, then it will maintain the previous status.

Under the cooling control,

When the actual temperature (T) < the setting temperature -the lower hysteresis temperature, then will stop cooling;

When the actual temperature (T) > the setting temperature +the upper hysteresis temperature, then will start cooling.

For example, the lower hysteresis temperature is 1K, the upper hysteresis temperature is 2K, the setting temperature is 26°C, if T is lower than 25°C, then it will stop cooling; if T is lower than 28°C, then it will start cooling; if T is between 28~25°C, then it will maintain the previous status.

2-point control mode is a very simple control mode. When adopting this control mode, it is necessary to set the upper hysteresis temperature and the lower hysteresis temperature through parameters. When setting the hysteresis temperature, the following effects need to be considered

1. When hysteresis interval is small, the temperature range will be small, however, frequent sending of control value will bring large load to the bus;

2. When hysteresis interval is large, the switch switching frequency will be low, but it is easy to cause uncomfortable temperature change.

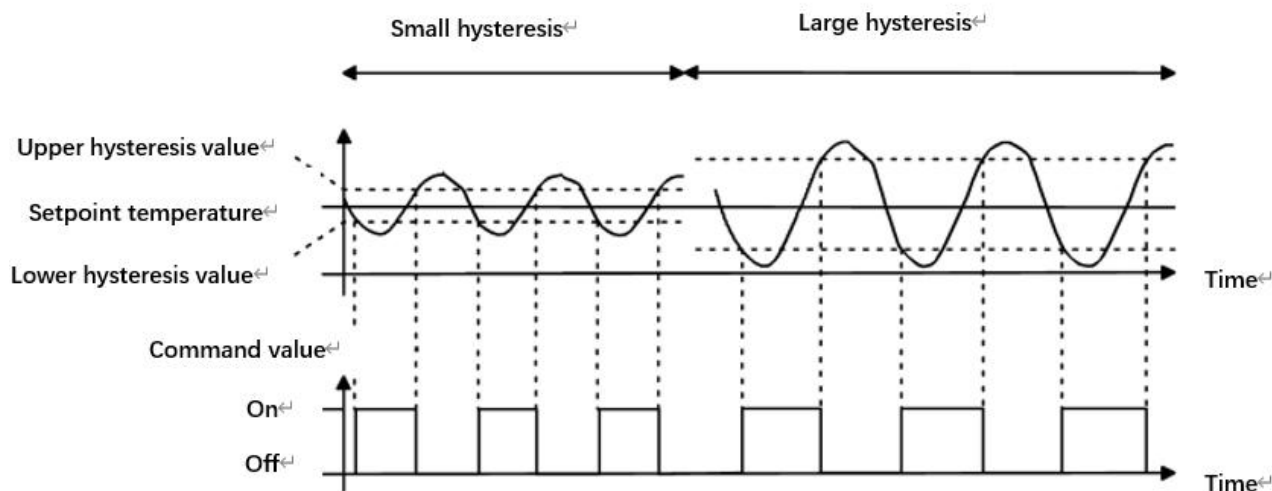

Fig5.3.1.2(2) Effects of hysteresis on control value switch action(heating) under2-point control mode
Parameters as follow are suitable for PWN control:

Parameter "PWM cycle time [1..255]min"

This parameter is only visible when the control type is "Switching PWM(use PI control)". Set the period of the control object cycle to send the switch value, the object sends the switch value according to the duty cycle of the control value. For example, if the set period is 10 min and the control value is 80%, then the object will send an open telegram for 8 min. If the control value is changed, the time duty ratio of the on/ off telegram of the object will also change, but the period is still the time of parameter setting.

Options: **1..255**

The PI values of "Switching PWM (use PI control)" and "Continuous control (use PI control)" are the same, only different in control objects, the control object of "Continuous control" output PI value(1byte) directly, while the control value of "Switching PWM" output a "on/off" telegram according to the duty cycle of the control value.

Parameters as follow are suitable for PI control:**Parameter "Heating speed"****Parameter "Cooling speed"**

These two parameters are for setting the responding speed of heating or cooling controller.

Different responding speeds are suitable for different environments.

Options:

Hot water heating (5K/150min)

Underfloor heating (5K/240 min)

Electrical heating (4K/100min)

Split unit (4K/90min)

Fan coil unit (4K/90min)

User defined

Options

Cooling ceiling (5K/240min)

Split unit (4K/90min)

Fan coil unit(4K/90min)

User defined

—Parameter“Proportional range [10..100]*0.1K”

—Parameter“Reset time [0..255]min”

These two parameters are visible when “User defined” is selected. Set the PI value of PI controller.

Options: **10..100 (P value)**

Options: **0..255 (I value)**

Parameter“Send control value on change by [0...100,0=inactive]”

This parameter is visible when control type is “Continuous control (use PI control)”, for setting the changing value of the control value to be sent to the bus. Options: **0..100, 0=inactive**

In PI control mode, the predefined control parameters of each PI controller in heating or cooling system are recommended as follows:

(1) Heating

Heating type	P value	I value(integration time)	Recommended PI control type	Recommended PWM period
Hot water Heating	5K	150min	Continuous/PWM	15min
Underfloor heating	5K	240min	PWM	15-20min
Electrical heating	4K	100min	PWM	10-15min
Split unit	4K	90min	PWM	10-15min
Fan coil unit	4K	90min	Continuous	--

(2) Cooling

Cooling type	P value	I value(integration	Recommended	Recommended PWM
--------------	---------	---------------------	-------------	-----------------

		time)	PI control type	period
Cooling ceiling	5K	240min	PWM	15-20min
Split unit	4K	90min	PWM	10-15min
Fan coil unit	4K	90min	Continuous	--

(3) User defined

When the parameter “Heating/Cooling speed” is set to “User defined”, the parameter value of P (scale factor) and I (integration time) can be set through the parameter. When adjusting the parameters, refer to the fixed PI value mentioned in the above table. Even if the control parameters are adjusted slightly, the control behavior will be significantly different.

In addition, the integration time should be set properly. If the integration time is too long, the adjustment will be slow, and the oscillation will not be obvious; if the integration time is too small, the adjustment will be fast, but the oscillation will occur. 0 means the integral term is not used.

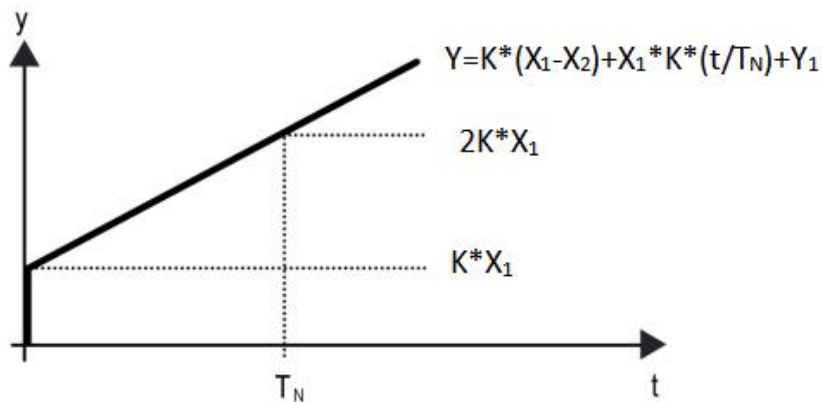

Fig.5.3.1.2 (3) control value of PI control mode

Y: control value

Y1: last control value

X1: temperature deviation = set temperature - actual temperature

X2: last temperature deviation = set temperature - actual temperature

T_N: integration time

K: scale factor (the scale factor is not zero)

PI control algorithm: $Y = K * (X1-X2) + X1 * K * t / T_N + Y1$

When the integration time is set to zero, the PI control algorithm is: $Y = K (X1-X2) + Y2$

Setting and influence of user-defined parameters:

Parameter setting	Effect
K: If the scale range is too small	Quick adjustment, and overshoot will occur
K: If the scale range is too small	Slow adjustment, but no overshoot
T _N : If the integration time is too short	Quick adjustment, but there will be oscillation
T _N : If the integration time is too long	Slow adjustment, no obvious oscillation

Parameter "Cyclically send control value [0...255]min"

This parameter is for setting the period for cyclically sending the control value to the bus. Options:

0..255

Parameter "Additional heating"

This parameter is for setting whether to enable additional heating.

Parameter as follow are visible when "Additional heating" is enable.

---Parameter "Control type"

This parameter is for setting the control type for the additional heating. Options:

1bit

1byte

—Parameter “Invert control value”

This parameter is for setting whether to invert control value or normal sending control value, so that the control value will be suitable for the valve type. Options:

No**Yes**

Yes: Sending the control value to the bus through objects after inverting the control value.

For additional heating valve:**—Parameter “Temperature difference to switch on additional heating [-100..-5]*0.1K”**

This parameter is for setting the temperature difference to switch on additional heating valve.

When the actual temperature (T) < (Setpoint temperature + Temperature difference), start heating.

. Options: -100...-5

—Parameter “Hysteresis to switch off additional heating [-20..-1]*0.1K”

This parameter is for setting the hysteresis to switch off additional heating.

When the actual temperature (T) > (Setpoint temperature + Temperature difference - Hysteresis), then will stop heating.

Options: -20... -1

Note: |Hysteresis| < |Temperature difference|, if not meet the condition, they can not be configured in ETS, and display red box warning, as shown as follow:

Temperature difference to switch on additional heating [-100..-5]	<input style="border: 2px solid red;" type="text" value="-9"/>	*0.1K
Hysteresis to switch off additional heating [-20..-1]	<input type="text" value="-10"/>	*0.1K

For additional cooling valve:

—Parameter“Temperature difference to switch on additional cooling [5..100]*0.1K”

This parameter is for setting the temperature difference to switch on additional cooling valve.

When the actual temperature (T) > (Setpoint temperature + Temperature difference), start cooling.

Options:5...100

—Parameter“Hysteresis to switch off additional cooling [1..20]*0.1K”

This parameter is for setting the hysteresis to switch off additional cooling.

When the actual temperature (T) < (Setpoint temperature + Temperature difference - Hysteresis), then will stop cooling.

Options:1...20

Note: |Hysteresis| < |Temperature difference|, if not meet the condition, they can not be configured in ETS, and display red box warning, as shown as follow:

Temperature difference to switch on additional cooling [5..100]	<input type="text" value="19"/>	*0.1K
Hysteresis to switch off additional cooling [1..20]	<input type="text" value="20"/>	*0.1K

—Parameter“Cyclically send control value [0..255]min”

This parameter is for setting the period for cyclically sending the control value to the bus. Options:
0..255

5.3.1.3 Parameter window "Fan auto.control"

This parameter window is visible when "Room temperature controller(RTC)" is selected as the controller type and fan speed auto.control function is enabled, as shown in Fig.5.3.1.3.

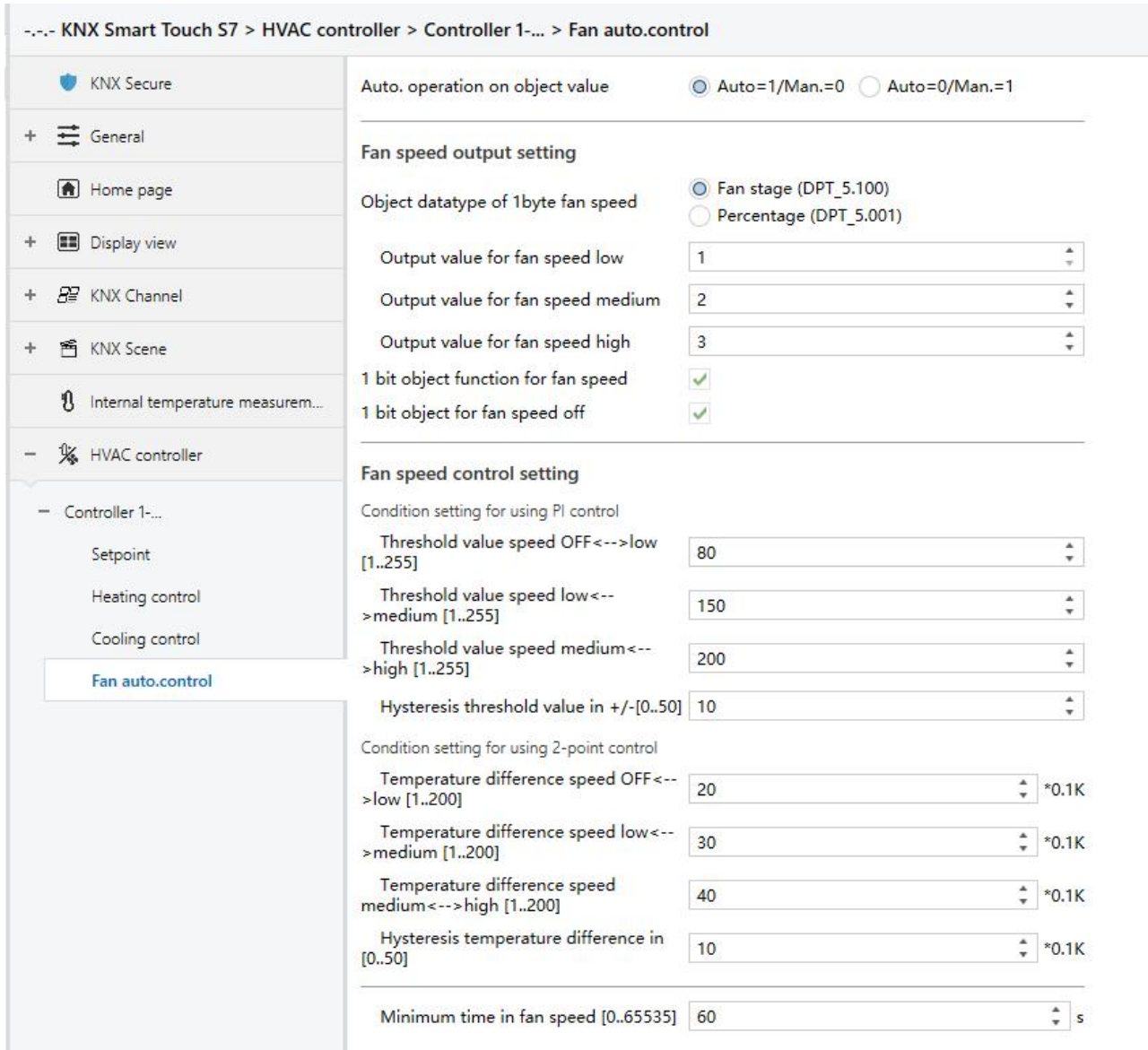

Fig.5.3.1.3"Fan" parameter window

Parameters of this window are visible when fan auto control enabled.

Parameter "Auto operation on object value"

This parameter is for setting the telegram value to activate automatic operation. Options:

Auto=1/Man.=0

Auto=0/Man.=1

Auto=1/Man.=0: When the object "Fan automatic operation" receives the telegram value "1", activate the automatic operation, when receive "0", exit the automatic operation.

Auto=0/Man.=1: When the object "Fan automatic operation" receives the telegram value "0", activate the automatic operation, when receive "1", exit the automatic operation.

After power-on, automatic operation is not activated by default.

Fan speed output setting

Parameter "Object datatype of 1byte fan speed"

This parameter is for setting the object datatype of 1 byte fan speed. Options:

Percentage (DPT_5.001)

Fan stage (DPT_5.100)

—Parameter "Output value for fan speed low/medium/high"

These three parameters are for setting the value sent for each fan speed switchover. Fan speed off when value is 0.

Options according to fan object datatype: 1..255 / 1..100%

Note: the out value and status value must meet the condition low<medium<high, if not, they can not be configured on ETS, and display red box warning, as shown as follow:

Output value for fan speed low

Output value for fan speed medium

Output value for fan speed high

Parameter "1 bit object function for fan speed"

This parameter is for setting whether to enable 1 bit object function for fan speed. 1 bit control objects of each fan speed are visible when enabled.

—Parameter "1 bit object for fan speed off "

This parameter is visible when previous parameter is enabled. Set whether to enable 1 bit object of fan speed off .

Fan speed control setting

Condition setting for using PI control

Under PI control, control value is PI operated within program, controller will power on/off fan or switch fan speed according to the threshold range of the control values.

Parameter "Threshold value speed OFF<-->low [1..255]"

Define threshold value for off-fan and low-level fan speeds, options: **1..255**

If the control value is greater than or equal to this setting threshold value, low-level fan speed will start running; if the control value is less than this setting threshold value, the fan will be turned off.

Parameter "Threshold value speed low<-->medium [1..255]"

Define the threshold value for switching the fan speed to medium fan speed, if the control value is greater than or equal to this setting threshold, the medium fan speed will start running. Options: **1..255**

Parameter "Threshold value speed medium<-->high [1..255]"

Define the threshold for switching the fan speed to high fan speed, if the control value is greater than or equal to this setting threshold, the high fan speed will start running. Options: **1..255**

Tip: The controller evaluates the threshold in ascending order.

First check →OFF <-->low fan speed threshold →low fan speed <-->medium fan speed →medium fan speed <-->high fan speed.

The correctness of functional execution is guaranteed only in this case:

The threshold of OFF <-> low fan speed is lower than that of low fan speed <-> medium fan speed, and the threshold of low fan speed <-> medium fan speed is lower than that of medium fan speed <-> high fan speed.

Parameter "Hysteresis threshold value in +/- [0..50]"

This parameter is for setting the hysteresis value of the threshold value, which can avoid the unnecessary action of the fan when the control value fluctuates near the threshold. Options: **0..50**

If value is 0, no hysteresis. Fan switch to speed once control value greater than threshold value;

Suppose that hysteresis value is 10 and the threshold is 50, then the upper limit threshold 60 (Threshold value+Hysteresis value) and the lower limit threshold 40 (Threshold value-Hysteresis value). When the control value is between 40 ~60, fan action will not be caused, and the previous status will still be maintained. Only less than 40 or greater than or equal to 60 will change the running status of the fan.

Condition setting for using 2-point control

Under 2-point control, controller will decide the fan power on/off or fan speed according to the temperature difference between the actual temperature and setpoint temperature.

Cooling: Temperature difference = actual temperature - setpoint temperature;

Heating: Temperature difference = setpoint temperature - actual temperature.

Parameter "Temperature difference speed OFF<->low[1..200]*0.1K"

This parameter is for setting the temperature difference between off-fan and low-level fan speeds.

Options: **1..200**

If the temperature difference is greater than or equal to this setting temperature difference, low-level fan speed will start running; if less than this setting temperature difference, the fan will be turned off.

Parameter "Temperature difference speed low<-->medium [1..200]*0.1K"

Define the temperature difference for switching the fan speed to medium fan speed, if the control value is greater than or equal to this setting temperature difference, the medium fan speed will start running.

Options: **1..200**

Parameter "Temperature difference speed medium<-->high [1..200]*0.1K"

Define the temperature difference for switching the fan speed to high fan speed, if the control value is greater than or equal to this setting temperature difference, the high fan speed will start running. Options: **1..200**

Parameter "Hysteresis temperature difference in [0..50] *0.1K"

This parameter is for setting the hysteresis value of the temperature difference, which can avoid the unnecessary action of the fan when the control value fluctuates near the temperature difference.

Options: **0..50**

If value is 0, no hysteresis. Fan switch to speed once control value greater than temperature difference;

Suppose that hysteresis value is 0.5°C and the temperature difference is 1°C, then the upper limit temperature difference 1.5°C (Temperature difference+Hysteresis value) and the lower limit temperature difference 0.5°C (Temperature difference-Hysteresis value). When the control value is between 0.5°C~1.5°C, fan action will not be caused, and the previous status will still be maintained. Only less than 0.5°C or greater than or equal to 1.5°C will change the running status of the fan.

Parameter "Minimum time in fan speed [0. 65535]"

Defines the residence time of the fan from the current fan speed to a higher fan speed or lower fan speed, that is, the minimum time for a fan speed operation.

If you need to switch to another fan speed, you need to wait for this period of time before switching.

If the current fan speed has been running long enough, the fan speed can be changed quickly.

Options: **0..65535**

0: there is no minimum running time, but the delay switching time of fan speed still needs to be considered.

Note: The residence time for this parameter setting is only enabled in Auto mode.

5.3.2 Parameter window "Cotroller x-Ventilation controller"(x=1~6)

This parameter window is visible when "Ventilation controller" is selected as the controller type, which realizes the automatic control of wind speed, and the linkage control of wind speed with PM2.5, CO2, VOC detection value, as shown in Fig.5.3.2.

--- KNX Smart Touch S7 > HVAC controller > Controller 1-...

KNX Secure	Description (max 30char.)	<input type="text"/>
+ General	Controller type	<input type="radio"/> Room temperature controller (RTC) <input checked="" type="radio"/> Ventilation controller
Home page	Auto.operation on object value	<input checked="" type="radio"/> Auto=1/Man.=0 <input type="radio"/> Auto=0/Man.=1
+ Display view	State of Auto.operation after startup	<input checked="" type="radio"/> Disable <input type="radio"/> Enable
+ KNX Channel	Fan speed output setting	
+ KNX Scene	Object datatype of 1byte fan speed	<input type="radio"/> Fan stage (DPT_5.100) <input checked="" type="radio"/> Percentage (DPT_5.001)
Internal temperature measurem...	Output value for fan speed low	<input type="text" value="33"/> %
- HVAC controller	Output value for fan speed medium	<input type="text" value="67"/> %
	Output value for fan speed high	<input type="text" value="100"/> %
	Fan speed control setting	
	Control value reference from	<input type="text" value="PM2.5"/>
	Object datatype of PM2.5	<input checked="" type="radio"/> Value in ug/m3(DPT_7.001) <input type="radio"/> Float value in ug/m3(DPT_9.030)
	Period for request control value [0...255,0=inactive]	<input type="text" value="10"/> min
	The fan speed status when the control value error	<input type="text" value="OFF"/>
	Threshold value OFF<-->speed low [1..999]	<input type="text" value="35"/>
	Threshold value speed low<-->medium [1..999]	<input type="text" value="75"/>
	Threshold value speed medium<-->high [1..999]	<input type="text" value="115"/>
	Hysteresis value is threshold value in +/- [10..30]	<input type="text" value="10"/>
	Minimum time in fan speed [0...65535]	<input type="text" value="10"/> s

Fig.5.3.2 "Cotroller x-Ventilation controller"(x=1~6) parameter window

Parameter "Auto. operation on object value"

This parameter is for setting the telegram value to activate automatic operation. Options:

Auto=1/Man.=0

Auto=0/Man.=1

Auto=1/Man.=0: When the object "Fan automatic operation" receives the telegram value "1", activate the automatic operation, when receive "0", exit the automatic operation.

Auto=0/Man.=1: When the object "Fan automatic operation" receives the telegram value "0", activate the automatic operation, when receive "1", exit the automatic operation.

After power-on, automatic operation is not activated by default.

Parameter "State of Auto.operation after startup"

This parameter is for setting whether to enable state of Auto.operation after startup the device.

Options:

Disable

Enable

Fan speed output setting**Parameter "Object datatype of 1byte fan speed"**

This parameter is for setting the object datatype of 1 byte fan speed. Options:

Fan stage (DPT 5.100)

Percentage (DPT 5.001)

——Parameter "Output value for fan speed low/medium/high"

These three parameters are for setting the value sent for each fan speed switchover. Fan speed off when value is 0. Options according to fan object datatype: **1..255 / 1..100**

Fan speed control setting**Parameter "Control value reference from"**

This parameter is for setting the reference of control value under automatic operation. Options:

PM2.5

CO2

VOC

Parameter "Object datatype of PM2.5/VOC"

These parameters are for setting the datatype of PM2.5/VOC. Datatype determines object type, select it according to the docking PM2.5 or VOC sensor data type. Options:

Value in ug/m3(DPT 7.001)

Float value in ug/m3(DPT 9.030)

DPT_7.001: Suitable for integrated value.

DPT_9.030: Suitable for float value.

Parameter "Object datatype of CO2"

This parameter is for setting the datatype of CO2. Datatype determines object type, select it according to the docking CO2 sensor data type. Options:

Value in ppm(DPT 7.001)

Float value in ppm(DPT 9.008)

DPT_7.001: Suitable for integrated value.

DPT_9.008: Suitable for float value.

Parameter "Period for request control value [0...255,0=inactive]min"

This parameter is for setting the time period for device to send a control value read request to external sensor after bus recovery or finish programming . Options: **0..255**

Parameter "The fan speed status when the control value error"

This parameter is for setting the default fan speed of ventilation system when control value is error. Options:

Off

Low

Medium

High

Parameter "Threshold value OFF<->speed low [1..999]/ [1..4000]"

Define threshold value for off-fan and low-level fan speeds, options: **1..999/1..4000**

If the control value is greater than or equal to this setting threshold value, low-level fan speed will start running; if the control value is less than this setting threshold value, the fan will be turned off.

Parameter "Threshold value speed low<->medium [1..999]/ [1..4000]"

Define the threshold value for switching the fan speed to medium fan speed, if the control value is greater than or equal to this setting threshold, the medium fan speed will start running. Options:

1..999/1..4000

Parameter "Threshold value speed medium<->high [1..999]/ [1..4000]"

Define the threshold for switching the fan speed to high fan speed, if the control value is greater than or equal to this setting threshold, the high fan speed will start running. Options: **1..999/1..4000**

Tip: The controller evaluates the threshold in ascending order.

First check →OFF <->low fan speed threshold →low fan speed <->medium fan speed →medium fan speed <->high fan speed.

The correctness of functional execution is guaranteed only in this case:

The threshold of OFF <-> low fan speed is lower than that of low fan speed <-> medium fan speed, and the threshold of low fan speed <-> medium fan speed is lower than that of medium fan speed <-> high fan speed.

Parameter "Hysteresis value is threshold in +/- [10..30]/[100..400]"

This parameter is for setting the hysteresis value of the threshold value, which can avoid the unnecessary action of the fan when the control value fluctuates near the threshold. Options:

10..30/100..400

For example, the control type is CO₂, the Hysteresis value is 100 and the threshold is 450, then the upper limit threshold 550 (Threshold value+Hysteresis value) and the lower limit threshold 350 (Threshold value-Hysteresis value). When the control value is between 350 ~550, fan action will not be

caused, and the previous status will still be maintained. Only less than 350 or greater than or equal to 550 will change the running status of the fan. As shown in the following figure:

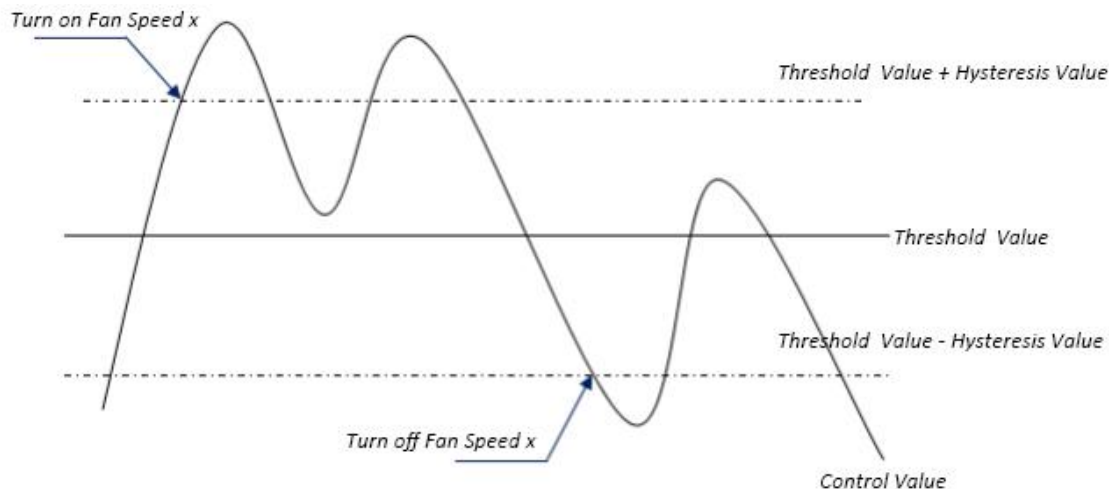

Note:

When hysteresis is enabled, if the threshold overlap occurs, fan action is specified as follows:

- 1) Hysteresis determines the control point where Fan speed conversion occurs;
- 2) If Fan speed conversion occurs, new fan speed is determined by control value and threshold

value, irrespective of hysteresis.

For example (1):

Take PM2.5 as an example

OFF <-> Low fan speed threshold value is 35

Low fan speed <-> Medium fan speed threshold value is 55

Medium fan speed <-> High fan speed threshold value is 75

Hysteresis value is 25

The fan speed of the fan turbine increases from OFF:

Fan OFF status will change at a control value of 60 ($\geq 25+35$), and new fan speed will be the mid-fan speed (because 60 is between 55 and 75, irrespective of hysteresis at this time), so the low fan speed is ignored;

The behavior of fan speed when descending from a high fan speed:

The high fan speed will change at a control value of 50 (<75-25), and new fan speed will be low fan speed (because 50 is between 35 and 55, irrespective of hysteresis), so the fan speed is ignored.

For example(2):

Take PM2.5 as an example

OFF <-> Low fan speed threshold value is 20

Low fan speed <-> Medium fan speed threshold value is 40

Medium fan speed <-> High fan speed threshold value is 70

Hysteresis value is 10

When fan speed is increasing from OFF:

The OFF status will be turned when the control value is 30 ($\geq 20+10$)

When the control value 41 is received, the new speed will be at medium (because the hysteresis is ignored when the value 41 is between 40 and 70), therefore the low speed is ignored.

When the control value 39 is received, the new speed will be at low (because the hysteresis is ignored when the value 39 is between 20 and 40)

When Fan Speed decreasing from high:

The high speed will be turned when the control value is 60 (<70-10)

When the control value 39 is received, the new speed will be at low (because the hysteresis is ignored when the value 39 is between 20 and 40), therefore the medium speed is ignored.

3) When the control value is 0, the fan will be off at any circumstances.

Parameter "Minimum time in fan speed [0..65535]s"

Defines the residence time of the fan from the current fan speed to a higher fan speed or lower fan speed, that is, the minimum time for a fan speed operation. Options: **0..65535**

If you need to switch to another fan speed, you need to wait for this period of time before switching.

If the current fan speed has been running long enough, the fan speed can be changed quickly.

0: there is no minimum running time, but the delay switching time of fan speed still needs to be considered.

Note: The residence time for this parameter setting is only enabled in Auto mode.

5.4 Parameter window "Human Centric Lighting(HCL)"

The parameter "Human Centric Lighting(HCL)" is visible when enabled in the "Advanced setting" interface shown in Fig.5.2.8, as shown in Fig.5.4. It is mainly for setting related parameters of brightness and colour temperature.

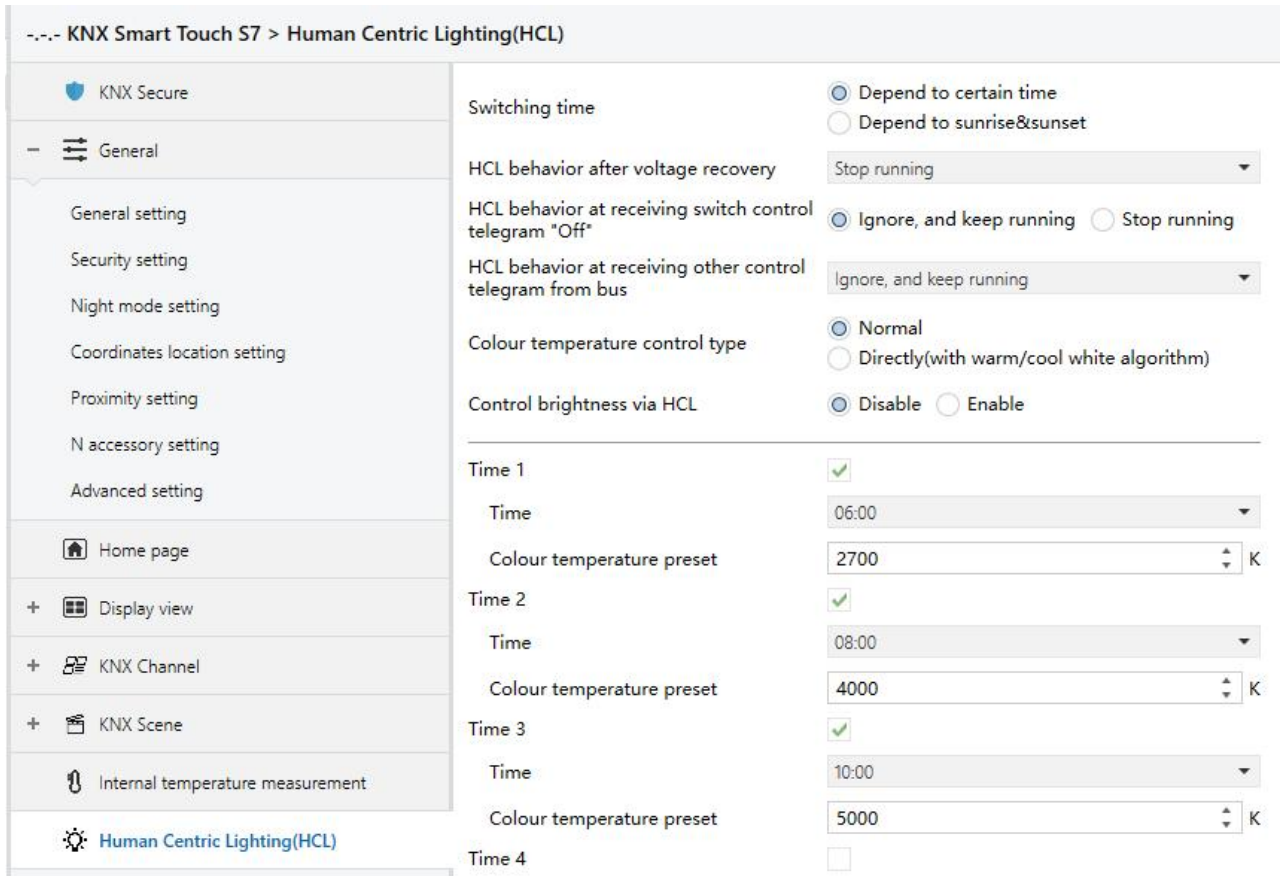

"Human Centric Lighting(HCL)-Depend to certain time"

--- KNX Smart Touch S7 > Human Centric Lighting(HCL)

<ul style="list-style-type: none"> KNX Secure General <ul style="list-style-type: none"> General setting Security setting Night mode setting Coordinates location setting Summer time setting Proximity setting Extension Sub Panel setting Advanced setting Home page Display view KNX Channel KNX Scene 	<p>Switching time</p> <p><input type="radio"/> Depend to certain time <input checked="" type="radio"/> Depend to sunrise&sunset</p> <p>HCL behavior after voltage recovery: As before voltage failure</p> <p>HCL behavior at receiving switch control telegram "Off": <input type="radio"/> Ignore, and keep running <input checked="" type="radio"/> Stop running</p> <p>HCL behavior at receiving other control telegram from bus: Ignore, and keep running</p> <p>Colour temperature control type: <input type="radio"/> Normal <input checked="" type="radio"/> Directly(with warm/cool white algorithm)</p> <hr/> <p>Time 1 <input checked="" type="checkbox"/></p> <p>Time: Sunrise +-0min</p> <p>Colour temperature preset: 2700 K</p> <p>Brightness preset: 50 %</p> <p>Time 2 <input checked="" type="checkbox"/></p> <p>Time: Sunrise +2h</p> <p>Colour temperature preset: 4000 K</p> <p>Brightness preset: 100 %</p> <p>Time 3 <input type="checkbox"/></p>
--	---

"Human Centric Lighting(HCL)-Depend to sunrise&sunset"

Fig.5.4 "Human Centric Lighting(HCL)"parameter window

Parameter "Switching time"

This parameter is for setting the method of switching time. Options:

Depend to certain time

Depend to sunrise&sunset

Parameter "HCL behavior after voltage recovery"

This parameter is for setting running behavior of HCL after voltage recovery. Options:

Start running

Stop running

As before voltage failure

Parameter "HCL behavior at receiving switch control telegram "Off"

This parameter is for setting running behavior of HCL when receiving switch control telegram "Off".

Options:

Ignore, and keep running

Stop running

Ignore, and keep running: ignore the receiving telegram and keep running HCL, no display the object "Switch control";

Stop running: stop running HCL.

Parameter "HCL behavior at receiving other control telegram from bus"

This parameter is for setting running behavior of HCL when receiving other control telegram from bus.

Options:

Ignore, and keep running

Ignore, but stop running

Update preset value, and keep running

Update preset value, and stop running

Ignore, and keep running: ignore the receiving telegram and keep running HCL;

Ignore, but stop running: ignore the receiving telegram but stop running HCL;

Update preset value, and keep running: update the current brightness or colour temperature when receiving their telegrams, and keep running HCL;

Update preset value, and stop running: update the current brightness or colour temperature when receiving their telegrams, but stop running HCL.

Note: telegrams received during that time period, update the parameter presets for that time period. In the HCL stops running, it is not logged. Updated presets will be saved when voltage failure.

Parameter "Colour temperature control type"

This parameter is for setting the control type of colour temperature. Options:

Normal

Directly(with warm/cool white algorithm)

Normal: send value of 1byte brightness and 2 byte colour temperature;

Directly(with warm/cool white algorithm): directly control, it has been built-in conversion algorithm for "Brightness + Colour Temperature" and Warm/cool white brightness, that is two 1byte objects, which is used for output brightness adjustment to control warm white LED and cool white LED.

——**Parameter"Control brightness via HCL"**

This parameter is visible when previous parameter is selected "Normal". Set whether to control brightness via HCL.

Parameters as follow are used to preset the brightness and colour temperature for each time period, up to set 10 time periods:

Parameter"Time X(X=1-10)"

When enabled, three parameter as follow are visible. This parameter is for setting whether to enable time x.

——**Parameter"Time"**

This parameter is for setting the preset time period, options are different according to the method of switching time.

When "Depend to certain time" is selected, options:

00:00

01:00

02:00

...

23:00

When "Depend to sunrise&sunset" is selected, options:

Sunrise -5h	Sunset +-0min
Sunrise -4h	Sunset +30min
...	Sunset +1h
Sunrise -1h	...
Sunrise -30min	Sunset +4h
Sunrise +-0min	Sunset +5h
...	

—Parameter“Colour temperature preset”

This parameter is for setting the preset colour temperature. Options:**2000..7000K**

—Parameter“Brightness preset”

This parameter is visible when control type of colour temperature is selected “Normal” and the parameter “Control brightness via HCL” is enabled, or the type is selected “Directly(with warm/cool white algorithm)”. Set the preset brightness. Options:

0%
5%
10%
...
95%
100%

5.5 Parameter window "Schedule function"

The parameter "schedule function" is visible when enabled in the "Advanced setting" interface shown in Fig.5.2.8, as shown in Fig.5.5, up to 16 time functions can be configured.



Fig.5.5 "schedule function"parameter window

Parameter "Number of schedule (max.16)"

This parameter is for setting the number of timers. Options: **1....16**

5.5.1 Parameter window "Schedule X"

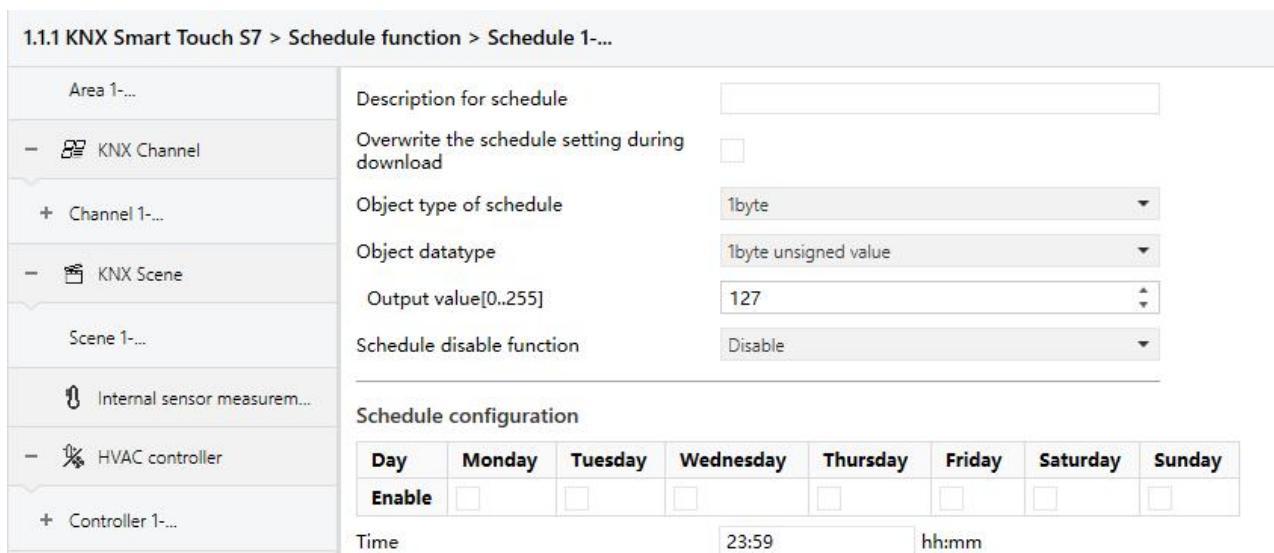

Fig.5.5.1 "Schedule X"parameter window

Parameter "Description for schedule function"

This parameter is for setting the description of schedule function, up to 18 characters can be input (up to 6 Chinese characters are supported).

Parameter "Overwrite the schedule function setting during download"

This parameter is for setting whether to overwrite the schedule function setting during download.

If enabled, the schedule function on screen is subject to the ETS configuration after the application is downloaded.

If disabled, if the channel is already activated, the ETS configuration will not be transmitted to screen, but it is not activated at first, the channel of schedule function on screen is subject to the ETS.

Parameter "Object type of schedule function"

This parameter is for setting the data type of the sending value when timing time of schedule x arrives. Options:

1bit

1byte

2byte

—Parameter "Object datatype"

This parameter is for defining the data type of 1byte or 2byte.

When 1byte, Options:

1byte unsigned value

1byte[scene control]

HVAC mode

When 2byte, Options:

2byte unsigned value

Temperature value

—Parameter "Output value/ scene No.[...]"

This parameter is for setting the telegram value to be sent when it arrives the time of time x. The range depends on the options of the previous parameter.

Parameter "Schedule disable function"

This parameter is for setting whether time function can be disabled or enabled via the object, or setting the trigger value of enable/disable timing. Options:

Disable

Disable=0/Enable=1

Disable=1/Enable=0

The following parameters are for setting the time of time x, when time arrives, perform time x.

Parameter "Monday/Tuesday/Wednesday/Thursday/Friday/Saturday/Sunday"

This parameter is for setting the day of a week to enable schedule x.

Parameter "Time"

This parameter is for setting the specific time of time x. Options:

Hours: **0..23**

Minutes: **0..59**

Note:The accuracy of RTC real-time clock inside the device is $\pm 20\text{ppm}$.

5.6 Parameter window "Alarm function"

The parameter "Alarm function" is visible when enabled in the "Advanced setting" interface shown in Fig.5.2.8, as shown in Fig.5.6, up to 24 alarm functions can be configured.

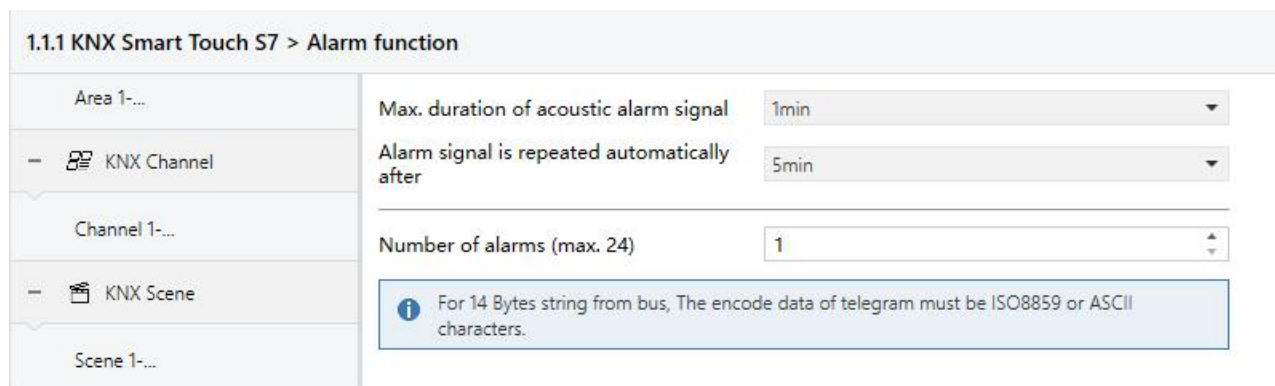

Fig.5.6 "Alarm function" parameter window

Parameter "Max. duration of acoustic alarm signal"

This parameter is for setting the time period of alarm tone. When receive the alarm telegram, play alarm tone immediately, if currently playing and it will not be interrupted and will not be re-timed. If receive the cancel alarm telegram when playing, it will be interrupted immediately. Options:

Disable

10s

20s

...

25min

30min

Disable: disable the alarm tone playing function;

Other options: the playing period of alarm tone.

Parameter "Alarm signal is repeated automatically after"

This parameter is for setting the interval at which alarm tone time automatically repeat, and the timing is only related to when the last play ended. Options:

Disable

10s

20s

...

25min

30min

Disable: disable the alarm tone repeat function;

Other options: when a playing period complete, it will automatically play again after a delay of the setting time.

Parameter "Number of alarms (max. 24) "

This parameter is for setting the number of alarms. Options: **1...24**



The encode data of telegram must be ISO8859 or ASCII characters

The encode data of alarm telegram is associated with interface language, when it is selected **Simplified Chinese, Traditional Chinese, Russian or Greek, use UTF-8; while other languages, use ISO8859.**

5.6.1 Parameter window "Alarm x"(x=1~24)

Parameter window "Alarm x"(x=1~24) as shown as Fig.5.6.1. It is mainly setting alarm function.

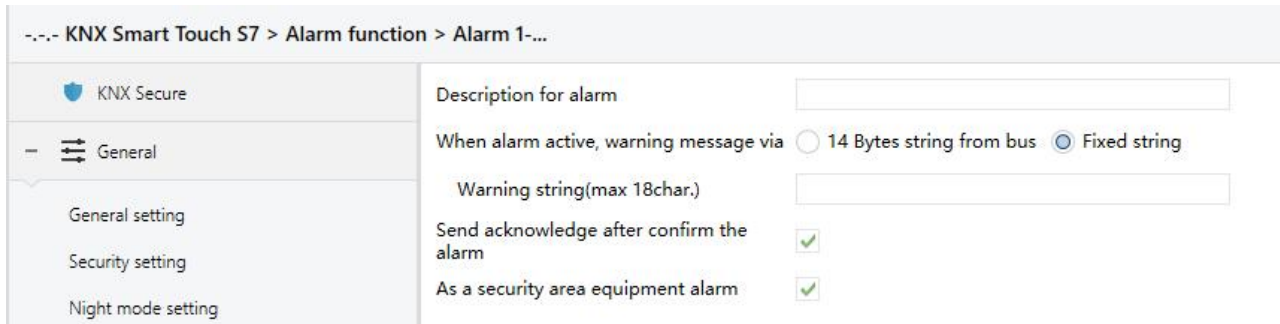

Fig.5.6.1 "Alarm x"(x=1~24) parameter window

Parameter "Description for alarm"

This parameter is for setting the description of alarm function, up to 18 characters can be input (up to 6 Chinese characters are supported).

Parameter "When alarm active, warning message via"

When alarm activated, this parameter is for setting input type of warning message, either by displaying a fixed string entered by ETS on the screen or by receiving a 14byte string from the bus.

Options:

Fixed string

14 Bytes string from bus

—Parameter "Warning string(max 18char.)"

This parameter is visible when previous parameter is selected "Fixed string". Set the indicate text when alarm activated.

Parameter "Send acknowledge after confirm the alarm"

This parameter is for setting whether to send a 1bit acknowledge telegram, the action that only needs to be processed when the user clicks on the screen to acknowledge the warning message.

Parameter "As a security area equipment alarm"

This parameter is for setting whether the device functions as a security area equipment alarm.

If enabled, the device will be displayed in the alarm equipment list in the equipment alarm settings.

If disabled, it will function as a regular alarm.

5.7 Parameter window "Logic function"

The parameter "Logic function" is visible when enabled in the "Advanced setting" interface shown in Fig.5.2.8, as shown in Fig.5.7. It is mainly setting logic function, up to 8 logic functions can be configured.

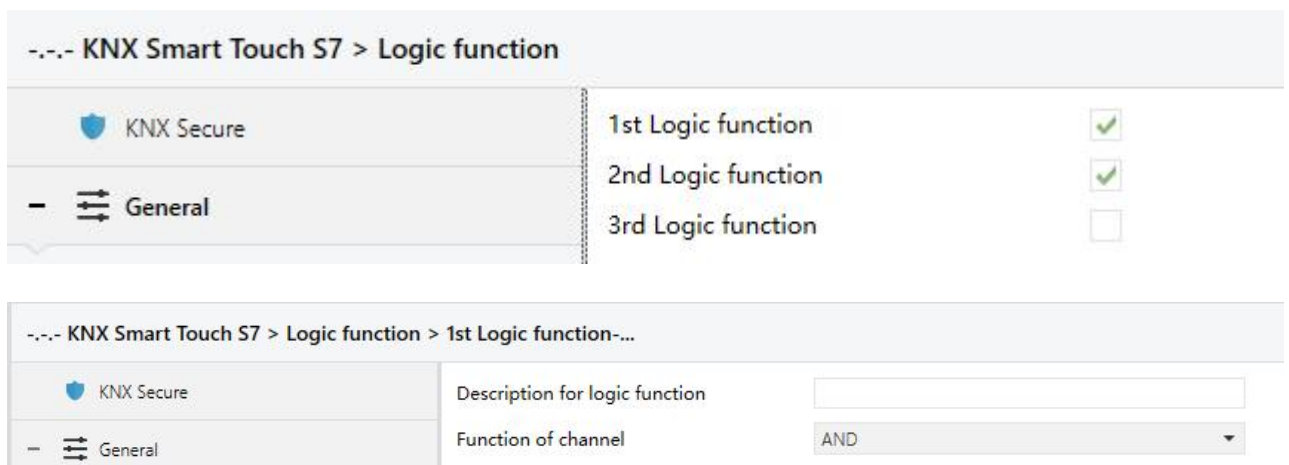

Fig.5.7 "Logic function"parameter window

Parameter "1st/2nd/3rd... Logic function "

This parameter is for setting the setting interface of logic function, display corresponding logic function page when select. Up to enable 8 logic functions.

Parameter "Description for logic function "

This parameter is for setting the name description for logic function, up to input 30 characters.

Parameter "Function of channel "

This parameter is for setting function of the channel. Options:

AND

OR

XOR

Gate forwarding

Threshold comparator

Format convert

Gate function

Delay function

Staircase lighting

AND/OR/XOR: as the parameter is similar to the communication object (only the logic algorithm is different), the following parameters taking one options for example.

5.7.1 Parameter window “AND/OR/XOR”

--- KNX Smart Touch S7 > Logic function > 1st Logic function---

<ul style="list-style-type: none"> KNX Secure General <ul style="list-style-type: none"> General setting Security setting Night mode setting Coordinates location sett... Proximity setting N accessory setting Advanced setting Home page Display view KNX Channel KNX Scene Internal temperature... Logic function <ul style="list-style-type: none"> 1st Logic function-... 2nd Logic function-... 	<p>Description for logic function</p> <p>Function of channel: XOR</p> <p>Input a: Disconnected Default value: <input checked="" type="radio"/> 0 <input type="radio"/> 1</p> <p>Input b: Disconnected Default value: <input checked="" type="radio"/> 0 <input type="radio"/> 1</p> <p>Input c: Disconnected Default value: <input checked="" type="radio"/> 0 <input type="radio"/> 1</p> <p>Input d: Disconnected Default value: <input checked="" type="radio"/> 0 <input type="radio"/> 1</p> <p>Input e: Disconnected Default value: <input checked="" type="radio"/> 0 <input type="radio"/> 1</p> <p>Input f: Disconnected Default value: <input checked="" type="radio"/> 0 <input type="radio"/> 1</p> <p>Input g: Disconnected Default value: <input checked="" type="radio"/> 0 <input type="radio"/> 1</p> <p>Input h: Disconnected Default value: <input checked="" type="radio"/> 0 <input type="radio"/> 1</p> <hr/> <p>Result is inverted: <input checked="" type="radio"/> No <input type="radio"/> Yes</p> <p>Read input object value after bus voltage recovery: <input checked="" type="radio"/> No <input type="radio"/> Yes</p> <p>Output send when: <input checked="" type="radio"/> Receiving a new telegram <input type="radio"/> Every change of output object</p> <p>Send delay time: Base: None</p> <p>Factor: 1..255: 1</p>
--	--

Fig.5.7.1 “Logic function_AND/OR/XOR” parameter window

Parameter “Input a/b/c/d/e/f/g/h”

This parameter is for setting whether input x to calculate, whether to normally calculate or inverted calculate. Options:

Disconnected

Normal

Inverted

Disconnected: not to calculate;

Normal: to directly calculate the input value;

Inverted: invert the input value, then to calculate. **Note: not to invert the initiate value.**

——**Parameter“Default value”**

This parameter is for setting the initial value of logic input x. Options:

0

1

Parameter“Result is inverted”

This parameter is for setting whether to invert the logic calculation result. Options:

No

Yes

No: output directly; Yes: output after inverting.

Parameter“Read input object value after bus voltage recovery”

This parameter is for setting whether to send the read request to the logic input object after device bus recovery or finish programming.

Parameter“Output send when”

This parameter is for setting the condition of sending logic result. Options:

Receiving a new telegram

Every change of output object

Receiving a new telegram: every time the object received a new input value will the logic result be sent to the bus;

Every change of output object: only when logic result has changed will it be sent to the bus.

Tip: when in the first time to logic calculate, the logic result will be sent even if it has no change.

Parameter "Send delay time"

- Base:** **None**
- 0.1s**
- 1s**
- ...**
- 10s**
- 25s**

Factor: **1..255**

This parameter is for setting the delay time for sending the logic calculation result to the bus.
 Delay time = Base × Factor, if option "None" of Base is selected, then there is no delay.

5.7.2 Parameter window "Gate forwarding"

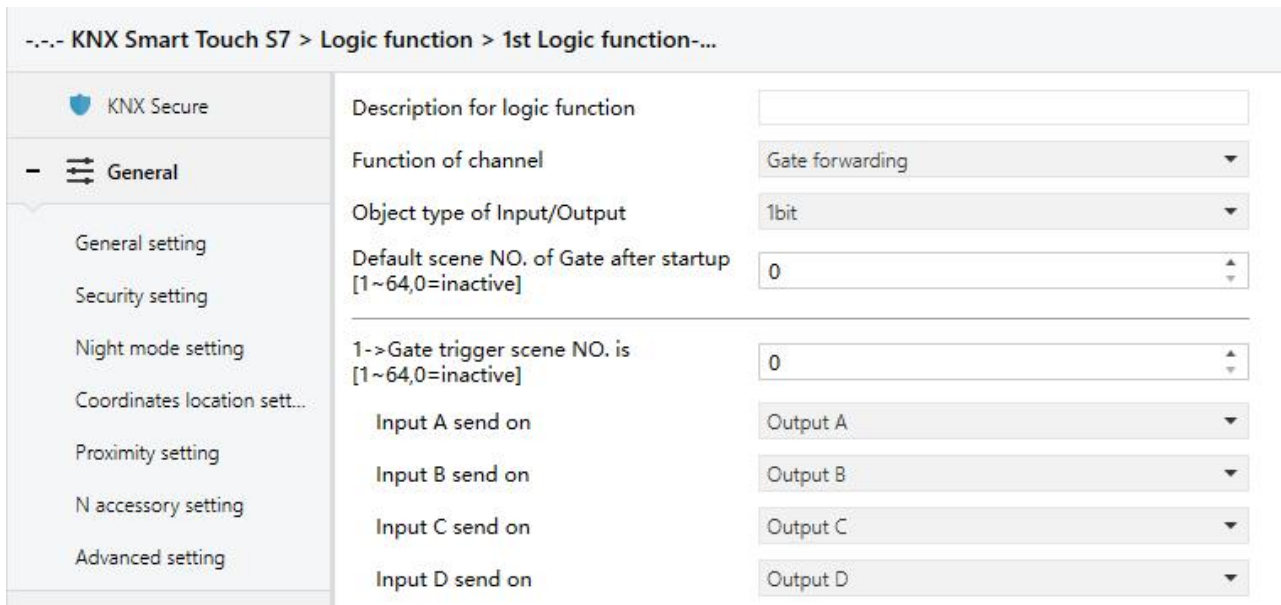

Fig.5.7.2 "Logic function_Gate forwarding" parameter window

Parameter "Object type of Input/Output"

This parameter is for setting the object type of input/output. Options:

1bit

4bit

1byte

Parameter "Default scene NO. of Gate after startup [1..64, 0=inactive]"

This parameter is for setting the initial scene where logical gate forwarding can be performed by default after device starts, which needs to be configured in the parameters. Options: **1..64, 0=inactive**

Note: gate scene is recommended to be selected before operating, or it will enable the initiate scene by default.

Parameter "x->Gate trigger scene NO. [1..64,0=inactive]" (x:1~8)

This parameter is for setting scene number of logic gate forwarding. Up to 8 trigger scene number can be set for each logic. Options: **1..64, 0=inactive**

—Parameter "Input A/B/C/D send on"

This parameter is for setting the output of input X (X=A/B/C/D) after gate forwarding. Options:

Output A

Output B

...

Output B,C,D

According to the options, one input can be forwarded into one or more outputs, the output value is the same as the input value.

5.7.3 Parameter window “Threshold comparator”

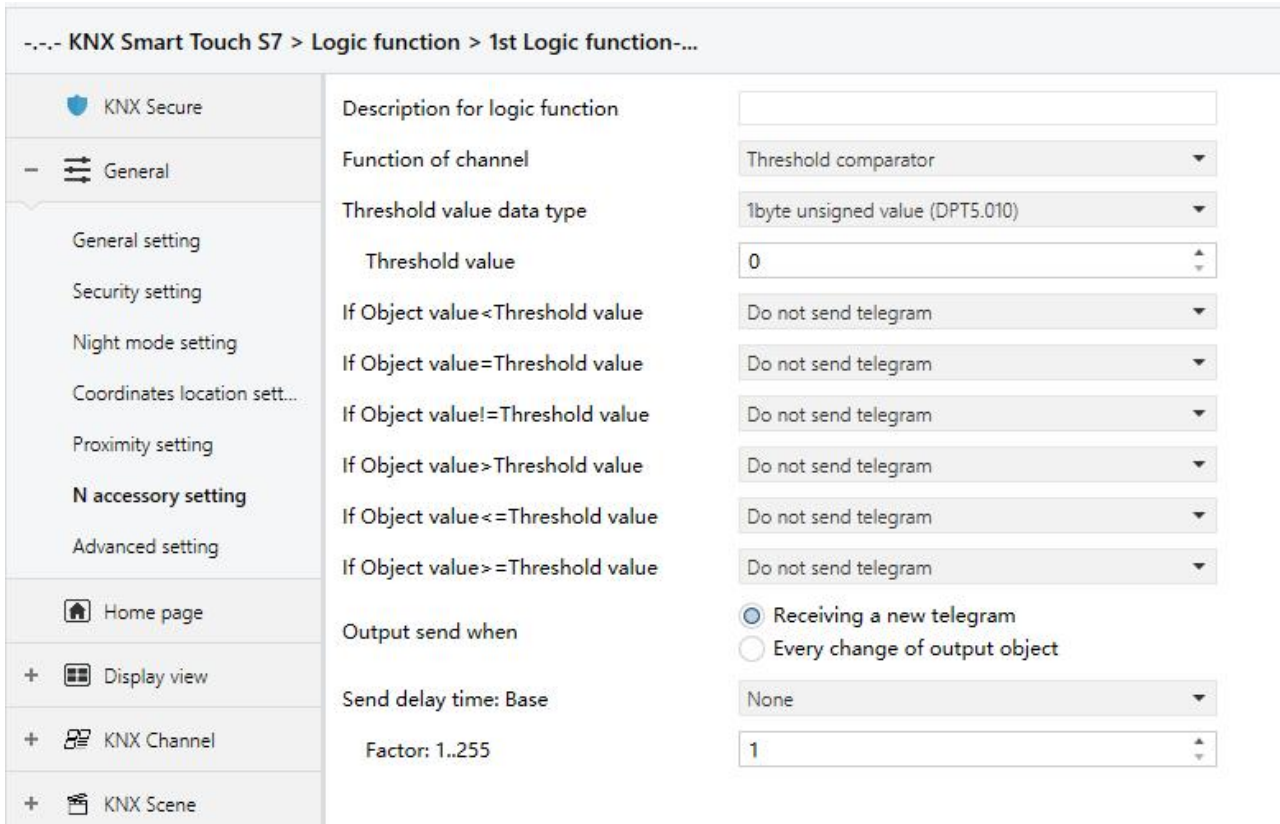

Fig.5.7.3 “Logic function_Threshold comparator”parameter window

Parameter “Threshold value data type”

This parameter is for setting the threshold value data type. Options:

- 4bit value (DPT3.007)**
- 1byte unsigned value (DPT5.010)**
- 2byte unsigned value (DPT7.001)**
- 2byte signed value (DPT8.x)**
- 2byte float value (DPT9.x)**
- 4byte unsigned value[0..4294967295]**
- Ext. temperature value (DPT 9.001)**
- Ext. humidity value (DPT 9.007)**
- Illuminance value (DPT 9.004)**

—Parameter “Threshold value ”

This parameter is for setting threshold value, the range depends on the data type. Options:

- 4bit value (DPT3.007) 0..15 / 1byte unsigned value (DPT5.010) 0..255 /**

2byte unsigned value (DPT7.001) 0..65535 / 2byte signed value (DPT8.x) -32768..32767 /

2byte float value (DPT9.x) -670760...670760 / 4byte unsigned value[0..4294967295]

0..4294967295 /

Ext. temperature value (DPT 9.001) -20..95°C / Ext. humidity value (DPT 9.007) 0..100% /

Illuminance value (DPT 9.004) 0..65535lux

Parameter "If Object value<Threshold value"

Parameter "If Object value=Threshold value"

Parameter "If Object value!=Threshold value"

Parameter "If Object value>Threshold value"

Parameter "If Object value<=Threshold value"

Parameter "If Object value>=Threshold value"

These parameters are for setting the logic result values that should be sent when threshold value less than, equal to, not equal to, greater than, less than and equal to, or greater and equal to the setting value. When object datatype is selected "2byte float value (DPT9.x)" or "Illuminance value (DPT 9.004)", can only set the object value less than or greater than threshold value. Options:

Do not send telegram

Send value "0"

Send value "1"

Do not send telegram: not consider to select this option;

Send value "0"/"1": when condition is satisfied, send telegram 0 or 1.

If there is a conflict between the setting options of the parameters, it is based on the value that should be sent, which meets the final parameter condition.

For example: parameter "If Object value=Threshold value" is set to be "Send value "0" "; parameter "If Object value<=Threshold value" is set to be "Send value "1" "; when object value is equal to the threshold value, then the logic result will send "1".

Parameter "Output send when"

This parameter is for setting the condition of sending logic result. Options:

Receiving a new telegram

Every change of output object

Receiving a new telegram: every time the object received a new input value will the logic result be sent to the bus;

Every change of output object: only when logic result has changed will it be sent to the bus.

Tip: when in the first time to logic algorithm, the logic result will be sent even if it has no change.

Parameter "Send delay time:"

Base:

None

0.1s

1s

...

25s

Factor: 1..255

This parameter is for setting the delay time for sending the logic algorithm result to the bus. Delay time = Base x Factor, if option "None" of Base is selected, then there is no delay.

5.7.4 Parameter window "Format convert"

--- KNX Smart Touch S7 > Logic function > 1st Logic function---



<div style="border: 1px solid #ccc; padding: 5px; margin-bottom: 5px;">  KNX Secure </div> <div style="border: 1px solid #ccc; padding: 5px; margin-bottom: 5px;">  General </div> <div style="border: 1px solid #ccc; padding: 5px; margin-bottom: 5px;"> General setting </div> <div style="border: 1px solid #ccc; padding: 5px;"> Security setting </div>	Description for logic function <input type="text"/> Function of channel <input type="text" value="Format convert"/> Function <input type="text" value="2x1Bit-->1x2Bit"/> Output send when <input checked="" type="radio"/> Receiving a new telegram <input type="radio"/> Every change of output object
---	--

Fig.5.7.4 "Logic function _Format convert" parameter window

Parameter "Function"

This parameter is for setting the format convert type. Options:

2x1bit-->1x2bit

8x1bit-->1x1byte

1x1byte-->1x2byte

2x1byte-->1x2byte

2x2byte-->1x4byte

1x1byte-->8x1bit

1x2byte-->2x1byte

1x4byte-->2x2byte

1x3byte-->3x1byte

3x1byte-->1x3byte

Parameter "Output send when"

This parameter is for setting the condition of sending logic result. Options:

Receiving a new telegram

Every change of output object

Receiving a new telegram: every time the object received a new input value will the logic result be sent to the bus;

Every change of output object: only when logic result has changed will it be sent to the bus.

Tip: when in the first time to logic algorithm, the logic result will be sent even if it has no change.

5.7.5 Parameter window “Gate function”

--- KNX Smart Touch S7 > Logic function > 1st Logic function---

<ul style="list-style-type: none"> KNX Secure General General setting Security setting Night mode setting Coordinates location sett... Proximity setting N accessory setting 	<p>Description for logic function</p> <p>Function of channel</p> <p>Object type of Input/Output</p> <p>Filter function</p> <p>Value output</p> <p>Gate object value</p> <p>Gate status after voltage recovery</p> <p>Save input signal when gate close</p>	<p></p> <p>Gate function</p> <p>1bit[On/Off]</p> <p>Deactivate</p> <p><input checked="" type="radio"/> Normal <input type="radio"/> Inverted</p> <p><input checked="" type="radio"/> Normal <input type="radio"/> Inverted</p> <p><input type="radio"/> Disable <input checked="" type="radio"/> Enable</p> <p><input checked="" type="radio"/> No <input type="radio"/> Yes</p>
--	--	--

Fig.5.7.5 “Gate function”parameter window

Parameter “Object type of Input/Output”

This parameter is for setting the object type of input/output. Options:

1bit[On/Off]

1byte[0...100%]

1byte[0...255]

2byte[Float]

2byte[0...65535]

Parameter as follow are visible when “1bit[On/Off]” is selected.

—Parameter “Filter function ”

This parameter is visible when “1bit[On/Off]” is selected. Set whether to filter On or Off telegram, only pass one of them or pass all. Options:

Deactivate

On filter out

Off filter out

Deactivate: Do not filter the On or Off telegrams;

On filter out: Off can pass, On cannot pass;

Off filter out: On can pass, Off cannot pass.

——**Parameter“Value output ”**

This parameter is for setting whether to invert the value then output it. Options:

Normal

Inverted

Parameter“ Gate object value”

This parameter is for setting whether to invert the gate object value then output it. Options:

Normal

Inverted

Parameter“ Gate status after voltage recovery”

This parameter is for setting the gate status after power on. Options:

Disable

Enable

Parameter“ Save input signal when gate close”

This parameter is for setting whether to save input signal on gate close. Options:

No

Yes

No: disable to save the input, the input values received during the gate closing period are ignored;

Yes: enable to save the input, the input values received during the gate closing period are output when gate is open (whether the input value is changed or not).

5.7.6 Parameter window "Delay function"

Fig.5.7.6 "Delay function"parameter window

Parameter "Object type of Input/Output"

This parameter is for setting the object type of input/output. Options:

1bit[On/Off]

1byte[0..100%]

1byte[0..255]

2byte[Float]

2byte[0..65535]

Parameter "Delay time [0..6500]s"

This parameter is for setting the delay time that output object forwards the value when the input object receives the telegram. Options: **0..6500**

Note: Receive telegram again in delay time, re-timing.

5.7.7 Parameter window “Staircase lighting”

--- KNX Smart Touch S7 > Logic function > 1st Logic function---

KNX Secure	Description for logic function	<input type="text"/>
General	Function of channel	Staircase lighting
General setting	Trigger value	1
Security setting	Object type of output	<input checked="" type="radio"/> 1bit <input type="radio"/> 1byte
Night mode setting	Duration time of staircase lighting [10..6500]	10 s
Coordinates location sett...	Send value 1 when trigger	<input type="radio"/> OFF <input checked="" type="radio"/> ON
Proximity setting	Send value 2 after duration time	<input checked="" type="radio"/> OFF <input type="radio"/> ON
N accessory setting	Retriggering	<input type="radio"/> Disable <input checked="" type="radio"/> Enable

Fig.5.7.7 “Staircase lighting”parameter window

Parameter “Trigger value”

This parameter is for setting the telegram value of the object “Trigger value”. Options:

0

1

0 or 1

Parameter “Object type of output”

This parameter is for setting the object type of output. Options:

1bit

1byte

Parameter “Duration time of staircase lighting[10..6500]s”

This parameter is for setting duration time of staircase lighting after the stair light power on.

可选项：**10..6500**

Parameter “Send value 1 when trigger”

Parameter “Send value 2 after duration time”

These parameters are for setting the value to send. Send value 1 when trigger, and then send

value 2 after duration time. Options display according to the output object datatype.

When 1 bit, options:

OFF

ON

When 1 byte , options: **0..255**

Parameter "Retriggering"

This parameter is for setting whether to trigger re-timing when received trigger value in delay time.

Options:

Disable

Enable

5.8 Parameter window "Scene group function"

The parameter "Scene group function" is visible when enabled in the "Advanced setting" interface shown in Fig. 5.2.8, as shown in Fig.5.8(1) ,Fig.5.8(2)and Fig.5.8(3). It is mainly setting scene group function, up to 8 scene group functions can be configured,each group with 8 outputs.

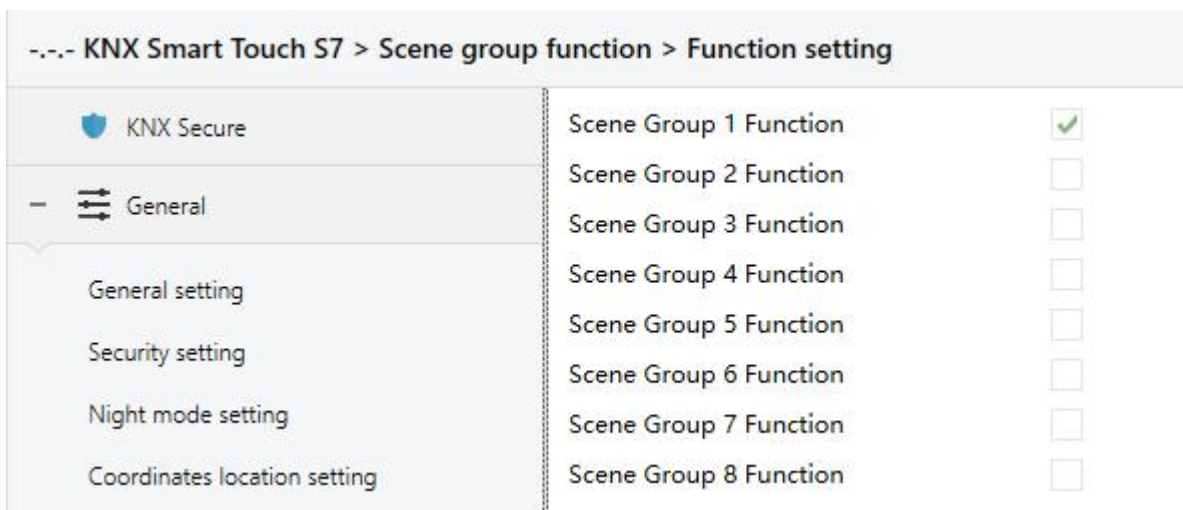

Fig.5.8(1) "Scene Group function"parameter window

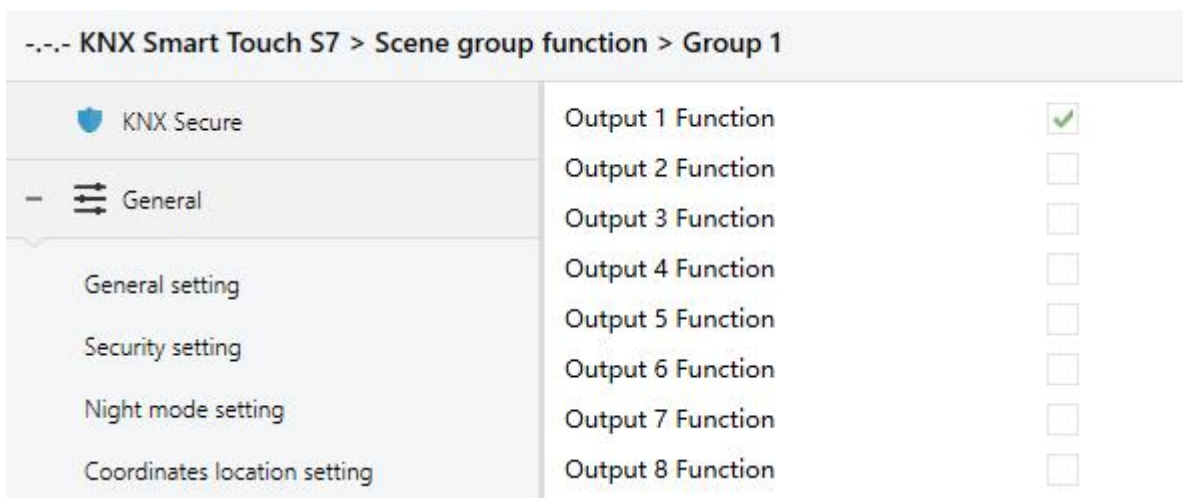

Fig.5.8(2) "Group X"parameter window

--- KNX Smart Touch S7 > Scene group function > Group 1 > Output 1 Function

<p>KNX Secure</p> <p>General</p> <p>General setting</p> <p>Security setting</p> <p>Night mode setting</p> <p>Coordinates location setting</p> <p>Proximity setting</p> <p>N accessory setting</p> <p>Advanced setting</p>	<p>Description for Output 1 function</p> <p>Object type of Output 1</p> <p>1->Output 1 trigger scene NO. is [1~64,0=inactive]</p> <p>Object value of Output 1</p> <p>Delay time for sending [0..255]</p> <hr/> <p>2->Output 1 trigger scene NO. is [1~64,0=inactive]</p> <p>Object value of Output 1</p> <p>Delay time for sending [0..255]</p>	<p></p> <p>1bit</p> <p>0</p> <p><input checked="" type="radio"/> 0 <input type="radio"/> 1</p> <p>0 *0.1s</p> <hr/> <p>0</p> <p><input checked="" type="radio"/> 0 <input type="radio"/> 1</p> <p>0 *0.1s</p>
---	---	---

Fig.5.8(3) "Output Y function" parameter window

Parameter "Scene Group X Function, (X=1-8)"

This parameter is for setting whether to enable scene group x function, up to 8 scene groups.

Parameter "Output Y Function, (Y=1-8)"

This parameter is for setting whether to enable output Y of scene group X, up to 8 output functions for each scene group.

As 8 group functions are the same, and 8 output functions of each group as well, the following description only about one output of a group.

Parameter "Description for Output Y function, (Y=1-8)"

This parameter is for setting the name description for output Y of group X, up to input 30 characters.

Parameter "Object type of Output Y, Y=(1-8)"

This parameter is for setting the object type of output Y of group X. Options:

1bit

1byte

2byte

RGB

RGBW

—Parameter“Object datatype”

This parameter is for setting the datatype of 1byte or 2byte.

When the datatype is 1byte, options:

1byte unsigned value

HVAC mode

When the datatype is 2byte, options:

2byte unsigned value

Temperature value

Parameter “z->Output 1 trigger scene NO. is [1~64,0=inactive],(z=1-8)”

This parameter is for setting the triggered scene number of output y of group x. Up to 8 triggered scene of each output can be configured. Options:**0..64, 0=inactive**

—Parameter“Object value of Output Y”

This parameter is for setting the output value, the range depends on the data type of output Y.

When the datatype is 1bit, options: **0..1**

When the datatype is 1byte-1byte unsigned value, options: **0..255**

When the datatype is 1byte-HVAC mode, options:

Comfort mode

Standby mode

Economy mode

Frost/heat protection

When the datatype is 2byte-2byte unsigned value, options: **0..65535**

When the datatype is 2byte-Temperature value, options:

-5°C

-4°C

...

45°C

——参数“RGB value of Output y”

When the datatype is RGB this parameter is visible, used for setting the RGB value of output y.

Options: #000000...#FFFFFF

——参数“White value of Output y”

When the datatype is RGBW this parameter is visible, used for setting the white value of output y.

Options: 0.255

——Parameter“ Delay time for sending [0...255]*0.1s ”

This parameter is for setting the delay time for sending the output value to the bus. Options:

0..255

5.9 Parameter window "Home page"

1.1.1 KNX Smart Touch S7 > Home page

KNX Secure

General

General setting

Security setting

Coordinates location setting

Summer time setting

Proximity setting

Advanced setting

Home page

Display view

KNX Channel

Channel 1-...

KNX Scene

Scene 1-...

Internal sensor measurem...

Overwrite the home page setting during download

Widget selection in the home page

Number of widgets (max. 24 channels or scenes)

▼	▼	▼	▼
▼	▼	▼	▼
▼	▼	▼	▼

i Note: If the channel or scene is not enabled, it can not be selected.





Function layout	Function including	Preview
Single grid	Press/Release switch, Switch, Relative dimming, RGB dimming, RGBW dimming, RGBCW dimming, Energy metering, Temperature sensor, Humidity sensor, PM2.5 sensor, PM10 sensor, VOC sensor, AQI sensor, CO2 sensor, Brightness sensor, Wind sensor, I/O sensor, Value sender, Scene	
Horizontal double grid	Curtain step/move, Roller blind step/move, Curtain position, Roller blind position, Venetian blind position and slat, Air conditioner, Room temperature unit, Ventilation system, Audio control	
Vertical double grid	Brightness dimming, Relative&Brightness dimming, Colour temperature dimming	

Fig.5.9 "Home page"parameter window

Parameter "Overwrite the home page setting during download"

This parameter is for setting whether to overwrite the home page setting during the download.

Widget selection in the home page

Parameter "Number of widgets (max.24 channels or scenes)"

This parameter is for setting the number of widgets.Options:1...24

The device are options:Channel 1...Channel 120/Scene 1-Scene 30

5.10 Parameter window "Display view"

--- KNX Smart Touch S7 > Display view

KNX Secure

General

General setting

Security setting

Coordinates location setting

Summer time setting

Proximity setting

Advanced setting

Home page

Display view

Area 1...

+ KNX Channel

+ KNX Scene

Internal sensor measurem...

Setting for area view

Number of areas (max. 12)

Layout preview



Category setting for device view

Item	Category name description	Function including
Lighting	Lighting	Switch, Relative dimming, Brightness dimming, Relative&Brightness dimming, RGB dimming, RGBW dimming, RGBCW dimming, Colour temperature dimming
Curtain	Curtain	Curtain step/move, Roller blind step/move, Curtain position, Roller blind position, Venetian blind position and slat
HVAC	HVAC	Air conditioner, Room temperature unit, Ventilation system
Audio	Audio	Audio control
Energy	Energy	Energy metering
Environment	Environment	Temperature sensor, Humidity sensor, PM2.5 sensor, PM10 sensor, VOC sensor, AQI sensor, CO2 sensor, Brightness sensor, Wind sensor
I/O Sensor	I/O Sensor	I/O sensor
Other	Other	Press/Release switch, Value sender

Layout preview



Fig.5.10 "Display view"parameter window

Setting for area view

Parameter "Number of areas (max. 12)"

This parameter is for setting the number of areas.Options:1....12

Category description setting for device view

Item	Function including
Lighting	Switch, Relative dimming, Brightness dimming, Relative dimming, Relative&Brightness dimming, RGB dimming, RGBW dimming, RGBCW dimming, Colour temperature dimming
Curtain	Curtain step/move, Roller blind step/move, Curtain position, Roller blind position, Venetian blind position and slat.
HVAC	Air conditioner, Room temperature unit, Ventilation system.
Audio	Audio control
Energy	Energy metering
Environment	Temperature sensor Humidity sensor, PM2.5 sensor, PM10 sensor, VOC sensor, AQI sensor, CO2 sensor, Brightness sensor, Wind sensor.
I/O Sensor	I/O sensor
Other	Press/Release switch, Value sender

5.11 Parameter window "KNX Channel"

1.1.1 KNX Smart Touch S7 > KNX Channel

<ul style="list-style-type: none"> KNX Secure General <ul style="list-style-type: none"> General setting Security setting Coordinates location setting Summer time setting Proximity setting Advanced setting Home page Display view <ul style="list-style-type: none"> Area 1-... KNX Channel <ul style="list-style-type: none"> Channel 1-... KNX Scene 	<p>Number of channels (max. 120) <input type="text" value="1"/></p> <p>i For 14 Bytes string from bus, The encode data of telegram must be ISO8859 or ASCII characters.</p> <p>Channel status object read request after restart <input checked="" type="checkbox"/></p> <p>Time period request for common 1 [0..255,0=inactive] <input type="text" value="0"/> min</p> <p>Time period request for common 2 [0..255,0=inactive] <input type="text" value="0"/> min</p> <p>Time period request for common 3 [0..255,0=inactive] <input type="text" value="0"/> min</p> <p>Time period request for common 4 [0..255,0=inactive] <input type="text" value="0"/> min</p> <p>Time period request for common 5 [0..255,0=inactive] <input type="text" value="0"/> min</p> <p>Time period request for common 6 [0..255,0=inactive] <input type="text" value="0"/> min</p> <p>Time period request for common 7 [0..255,0=inactive] <input type="text" value="0"/> min</p> <p>Time period request for common 8 [0..255,0=inactive] <input type="text" value="0"/> min</p> <p>Time period request for common 9 [0..255,0=inactive] <input type="text" value="0"/> min</p> <p>Time period request for common 10 [0..255,0=inactive] <input type="text" value="0"/> min</p>
---	---

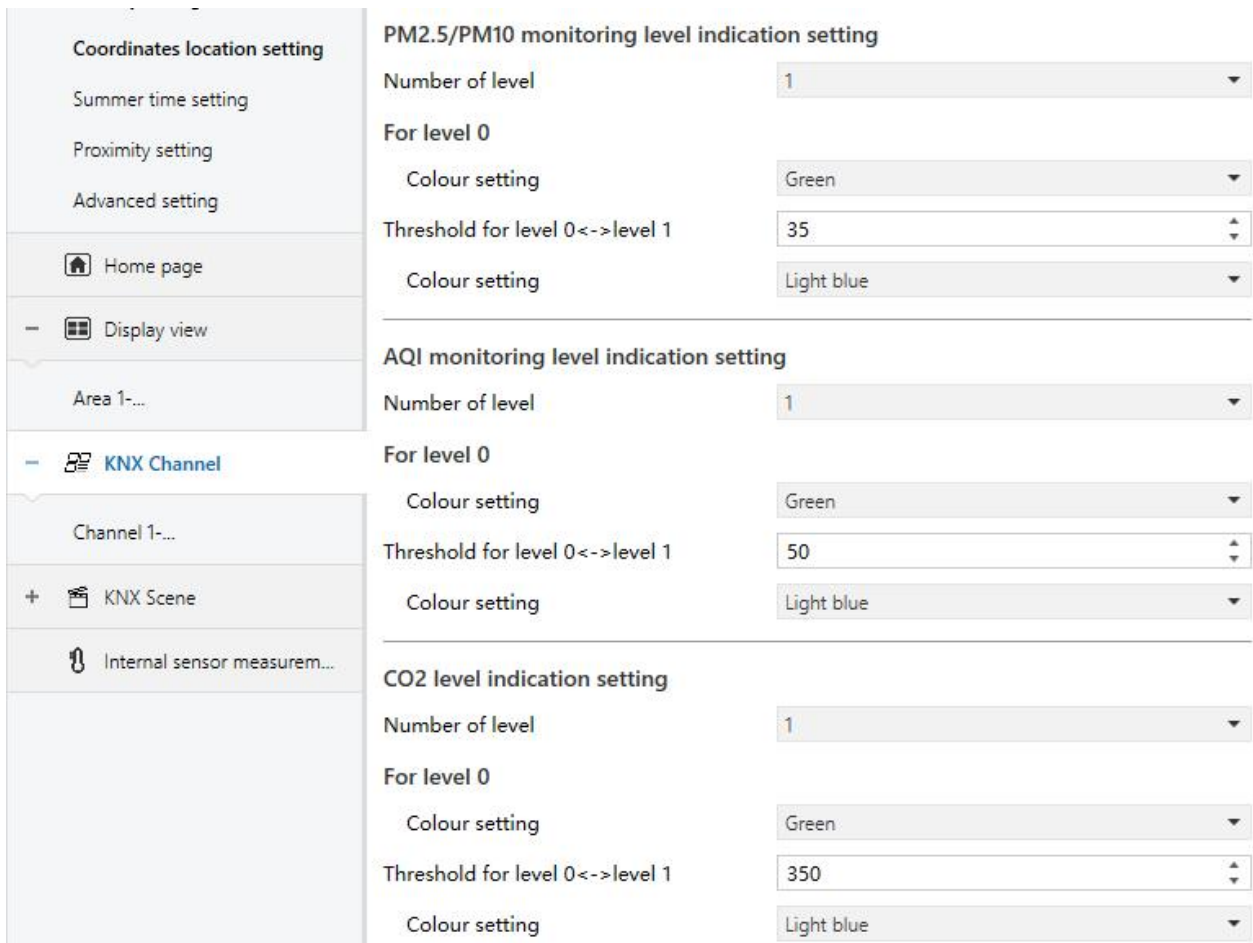

Fig.5.11 “KNX Channel”parameter window

Parameter “Number of channels (max.120)”

This parameter is for setting the number channels.Options:**1...120**

Parameter “Channel status object read request after restart ”

This parameter is for setting whether to send channel status object read request after restart.

Parameter “Time period request for common X [0..255,0=inactive] ,(X=1-10)”

This parameter is for setting time period request for querying the online status of the generic device.Options:**0...255min**

PM2.5/PM10/AQI/CO2/ monitoring level indication setting PM2.5/PM10/AQI/CO2**Parameter "Number of level"**

This parameter is for setting number of level. Options: **1...5**

Parameter "Colour setting"

This parameter is for setting the color of UI display fo each level. Options:

Green

Light blue

Yellow

Orange

Red

Dark red

Parameter "Threshold for level 0<->level 1"**Parameter "Threshold for level 1<->level 2"****Parameter "Threshold for level 2<->level 3"****Parameter "Threshold for level 3<->level 4"****Parameter "Threshold for level 4<->level 5"**

This parameter is for setting the threshold for each level. Options: **1...500/1...999**

5.11.1 Parameter window "Channel X"(X=1~120)

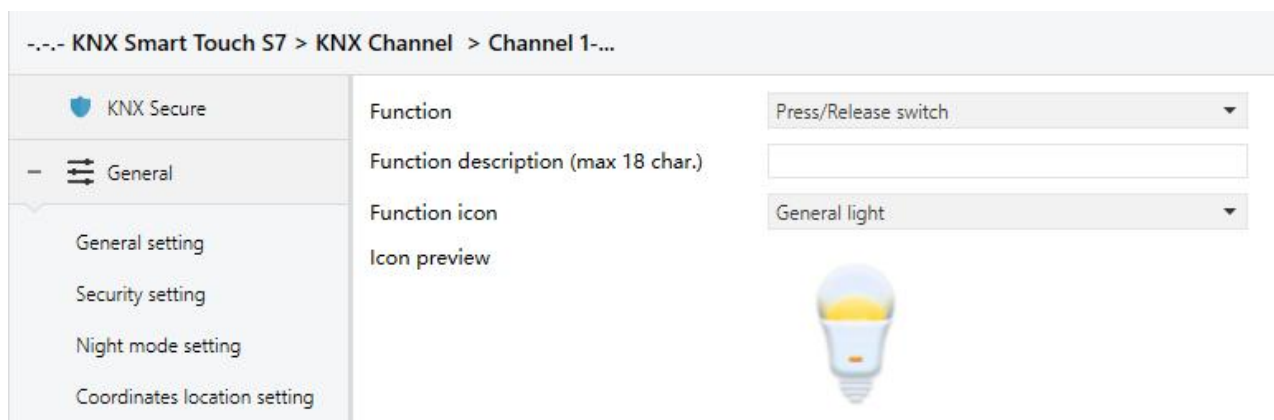

Fig.5.11.1 "Channel X"parameter window

Parameter "Function"

This parameter is for setting the device function.Options:

Press/Release switch		Ventilation system
Switch		Ventilation system(with auto fan speed)
Relative dimming		Audio control
Brightness dimming		Audio control(with on/off)
Relative&Brightness dimming		Audio control(play mode)
RGB dimming	RGB	Audio control(track information)
RGBW dimming	RGBW	Audio control(track information & playlist)
RGBCW dimming	RGBCW	Energy metering(power & energy)
Colour temperature dimming		Energy metering(power & energy & current)
Curtain step/move		Energy metering(power & energy & current & voltage)
Roller blind step/move		Temperature sensor
Curtain position		Humidity sensor
Roller blind position		PM2.5 sensor
Venetian blind position and slat		PM10 sensor
Air conditioner		VOC sensor
Air conditioner(with swing)		AQI sensor
Room temperature unit		CO2 sensor
Room temperature unit(with on/off)		Brightness sensor
Room temperature unit(with operation mode)		Wind sensor
Room temperature unit(with on/off & operation mode)		I/O sensor
Room temperature unit(with operation mode & fan speed)		Value sender

Parameter "Function description (max 18 char.)"

This parameter is for setting the function description of channel device,,up to 18 characters.

Parameter "Function icon"

This parameter is for setting the icon of channel device. Options :

General light

Ceiling light

...

AQI

The default icons corresponding to the function and the icons corresponding to the options are described in the appendix.

Chapters as follow explain the device function separately.

5.11.2 Parameter window of basic function

This chapter explains the basic functions, including switch,dimming,blinds,value sender,color temperature,color control(RGB,RGBW,RGBCW),audio control,room temperature control,Air conditioner,Ventilation System control,Air quality and Energy Metering display,etc.

5.11.2.1.Switch

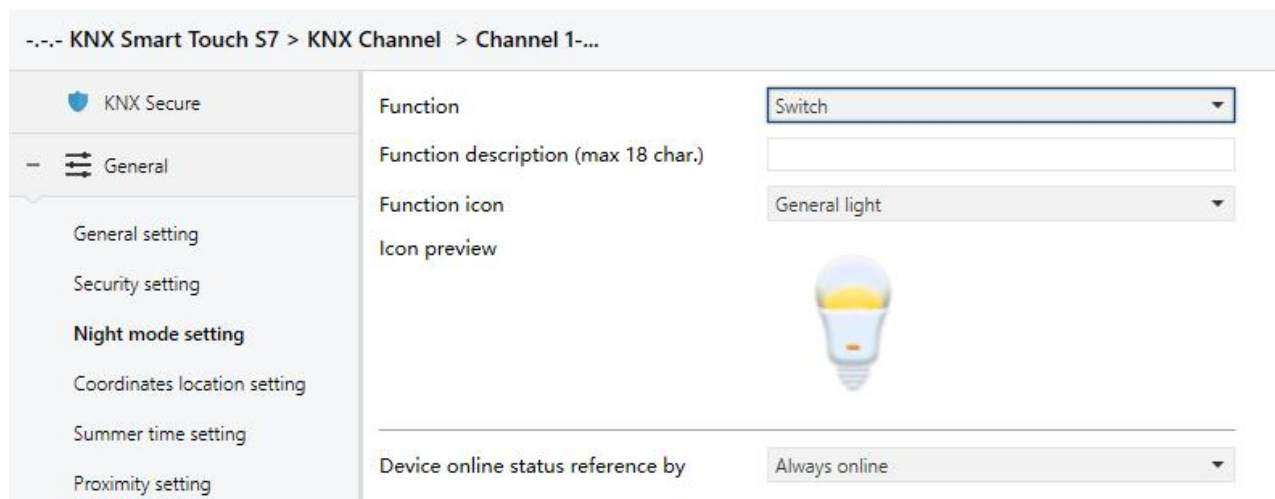

Fig.5.11.2(1) "Switch"parameter window

Parameter "Device online status reference by"

This parameter is for setting the reference type for sending read requests to KNX devices on the bus. Options:

Individual

Common 1

...

Common 10

Always online

Note:(Press/Release switch and value transmission, read-only display "Always online".)

—Parameter "Period for request device online status [1..255] min"

This parameter is visible when previous parameter is selected "Individual". Set the time period for individual device online status requests. Options: **0...255**

5.11.2.2.Press/Release switch

--- KNX Smart Touch S7 > KNX Channel > Channel 1-...

<ul style="list-style-type: none"> KNX Secure General <ul style="list-style-type: none"> General setting Security setting Night mode setting Coordinates location setting Summer time setting Proximity setting Extension Sub Panel setting Advanced setting 	<p>Function: <input type="text" value="Press/Release switch"/></p> <p>Function description (max 18 char.): <input type="text"/></p> <p>Function icon: <input type="text" value="General light"/></p> <p>Icon preview: </p> <hr/> <p>Device online status reference by: <input type="text" value="Always online"/></p> <hr/> <p>Work mode: <input checked="" type="radio"/> Press - ON / Release - OFF <input type="radio"/> Press - OFF / Release - ON</p> <p>Icon display: <input type="radio"/> OFF <input checked="" type="radio"/> ON</p>
---	--

Fig.5.11.2(2) "Press/Release switch" parameter window

Parameter "Work mode"

This parameter is for setting the work mode for Press/Release switch. Options:

Press - ON / Release - OFF

Press - OFF / Release - ON

Parameter "Icon display"



This parameter is for setting the indication status of the icons on the screen. Options:

OFF

ON





5.11.2.3. Relative dimming/brightness dimming/Relative&brightness dimming

--- KNX Smart Touch S7 > KNX Channel > Channel 1-...

Night mode setting	Function	Relative dimming
Coordinates location setting	Function description (max 18 char.)	
Summer time setting	Function icon	General light
Proximity setting	Icon preview	
Extension Sub Panel setting		
Advanced setting		
 Home page	Device online status reference by	Always online
+  Display view		

Relative dimming

--- KNX Smart Touch S7 > KNX Channel > Channel 1-...

Night mode setting	Function	Brightness dimming
Coordinates location setting	Function description (max 18 char.)	
Summer time setting	Function icon	General light
Proximity setting	Icon preview	
Extension Sub Panel setting		
Advanced setting		
 Home page	Device online status reference by	Always online
+  Display view		
-  KNX Channel		
Channel 1-...	Min. brightness value [0...50]	0 %
	Max. brightness value [51...100]	100 %

Brightness dimming

15.15.201 KNX Smart Touch S7 > KNX Channel > Channel 1-...

Coordinates location setting	Function	Relative&Brightness dimming
Summer time setting	Function description (max 18 char.)	
Proximity setting	Function icon	General light
Extension Sub Panel setting	Icon preview	
Advanced setting		
Home page	Device online status reference by	Individual
Display view	Period for request device online status [1...255]	10 min
KNX Channel	Min. brightness value [0...50]	0 %
Channel 1-...	Max. brightness value [51...100]	100 %
KNX Scene		
Internal temperature meas...		

Relative&Brightness dimming

Fig.5.11.2(3) "Relative/brightness dimming"parameter window

The following parameters are visible when "Brightness dimming/Relative&Brightness dimming" is selected.

Parameter "Min. brightness value [0..50]%"

This parameter is for setting the lower limit threshold of brightness. Options: **0..50**

Parameter "Max. brightness value [51..100]%"

This parameter is for setting the upper limit threshold of brightness. Options: **51..100**

5.11.2.4. Colour temperature dimming

15.15.201 KNX Smart Touch S7 > KNX Channel > Channel 1-...

KNX Secure	Function	Colour temperature dimming
General	Function description (max 18 char.)	
General setting	Function icon	Downlight
Security setting	Icon preview	
Night mode setting	Device online status reference by	Individual
Coordinates location setting	Period for request device online status [1...255]	10 min
Summer time setting	Reaction on 'OFF' operation	<input checked="" type="radio"/> Only switch object send value 0 <input type="radio"/> Brightness objects send value 0
Proximity setting	Reaction on 'ON' operation	<input checked="" type="radio"/> Only switch object send value 1 <input type="radio"/> Preset colour brightness value
Extension Sub Panel setting	Colour temperature control type	Normal(with 2byte absolute value)
Advanced setting	Min. colour temperature [2000...7000]	2700 K
Home page	Max. colour temperature [2000...7000]	6500 K
Display view		
KNX Channel		
Channel 1-...		

Color temperature dimming

Fig.5.11.2(4) "Colour temperature dimming"parameter window

Parameter "Reaction on 'OFF' operation"

This parameter is for setting whether send switch telegram 0 when the switch button is operated off, or whether send brightness telegram 0. Options:

Only switch object send value 0

Brightness objects send value 0

Parameter "Reaction on 'ON' operation"

This parameter is for setting whether send switch telegram 1 when the switch button is operated on, or whether send colour brightness telegram . Options:

Only switch object send value 1

Preset colour brightness value

Parameters as follow are visible when “Preset colour brightness value” is selected, used for setting colour temperature dimming.

—Parameter “Brightness value”

This parameter is for setting the visible preset value of brightness. Options: **0...100%**

Parameter “Colour temperature control type”

This parameter is for setting the control type of colour temperature. Options:

Normal (with 2 byte absolute value)

Normal (with 1 byte percentage value)

Directly (with warm/cool white algorithm)

Normal: Send value of 1 byte brightness and 2 byte colour temperature;

Directly (with warm/cool white algorithm): Directly control, the has been built-in “Brightness + Colour Temperature” and Warm/cool white brightness, that is 2 objects of 1 byte, which is used for output brightness adjustment to control warm white LED and cool white LED.

—Parameter “Status feedback object”

This parameter is visible when previous parameter is selected “Directly (with warm/cool white algorithm)”. Set the status feedback object. Options:

Brightness+Colour Temperature

Warm/cool white brightness

Brightness+Colour Temperature: Feedback of Brightness+Colour Temperature is to communicate accurately with the data from the other panels.

Warm/cool white brightness: Feedback of Warm/cool white brightness is to communicate with actuator.

Parameter “Min. colour temperature [2000..7000]K”

Parameter “Max. colour temperature [2000..7000]K”

These parameters are for setting the upper and lower limit threshold of colour temperature.

Options: **2000..7000**

5.11.2.5.RGB/RGBW/RGBCW/ dimming

--- KNX Smart Touch S7 > KNX Channel > Channel 1-...

<ul style="list-style-type: none"> KNX Secure General <ul style="list-style-type: none"> General setting Security setting Night mode setting Coordinates location setting Summer time setting Proximity setting Extension Sub Panel setting Advanced setting Home page Display view 	Function	RGB dimming
	Function description (max 18 char.)	
	Function icon	RGB light
	Icon preview	
	Device online status reference by	Always online
	Reaction on 'OFF' operation	<input checked="" type="radio"/> Only switch object send value 0 <input type="radio"/> Brightness objects send value 0
	Reaction on 'ON' operation	<input checked="" type="radio"/> Only switch object send value 1 <input type="radio"/> Preset colour brightness value
	Object datatype	<input checked="" type="radio"/> 1x3byte <input type="radio"/> 3x1byte

RGB dimming

--- KNX Smart Touch S7 > KNX Channel > Channel 1-...

<ul style="list-style-type: none"> KNX Secure General <ul style="list-style-type: none"> General setting Security setting Night mode setting Coordinates location setting Summer time setting Proximity setting Extension Sub Panel setting Advanced setting Home page Display view 	Function	RGBW dimming
	Function description (max 18 char.)	
	Function icon	RGB light
	Icon preview	
	Device online status reference by	Always online
	Reaction on 'OFF' operation	<input checked="" type="radio"/> Only switch object send value 0 <input type="radio"/> Brightness objects send value 0
	Reaction on 'ON' operation	<input checked="" type="radio"/> Only switch object send value 1 <input type="radio"/> Preset colour brightness value
	Object datatype	<input checked="" type="radio"/> 1x6byte <input type="radio"/> 4x1byte

RGBW dimming

15.15.201 KNX Smart Touch S7 > KNX Channel > Channel 1-...

KNX Secure

General

General setting

Security setting

Night mode setting

Coordinates location setting

Summer time setting

Proximity setting

Extension Sub Panel setting

Advanced setting

Home page

Display view

KNX Channel

Channel 1-...

KNX Scene

Function: RGBCW dimming

Function description (max 18 char.):

Function icon: RGB light

Icon preview: 

Device online status reference by: Individual

Period for request device online status [1...255]: 10 min

Reaction on 'OFF' operation: Only switch object send value 0
 Brightness objects send value 0

Reaction on 'ON' operation: Only switch object send value 1
 Preset colour brightness value

RGB object datatype: 1x3byte 3x1byte

Colour temperature control type: Normal(with 2byte absolute value)

Min. colour temperature [2000...7000]: 2700 K

Max. colour temperature [2000...7000]: 6500 K

RGBCW dimming

Fig.5.11.2(5) "RGB/RGBW/RGBCW dimming"parameter window

Parameter "Reaction on 'OFF' operation"

This parameter is for setting whether send switch telegram 0 when the switch button is operated off, or whether send brightness telegram 0. Options:

Only switch object send value 0

Brightness objects send value 0

Parameter "Reaction on 'ON' operation"

This parameter is for setting whether send switch telegram 1 when the switch button is operated on, or whether send colour brightness telegram . Options:

Only switch object send value 1

Preset colour brightness value

The following parameters are visible when "Preset colour brightness value" is selected.

—Parameter "RGB value"

This parameter is for setting the visible preset value of RGB. Options: **000000** **#FFFFFF**

—Parameter "White brightness value"

This parameter is for setting the visible preset value of white brightness. Options: **0..255**

—Parameter "Brightness value"

This parameter is for setting the visible preset value of brightness. Options: **0..255**

Parameter "Object datatype" / "RGB object datatype"

This parameter is for setting the object datatype of RGB or RGBW.

Options: **1x3byte/3x1byte/1x6byte/4x1byte**

Suitable for RGB/RGBCW type:

1x3byte

3x1byte

Suitable for RGBW type:

1x6byte

4x1byte

Parameters as follow are visible when "RGBCW dimming" is selected, used for setting colour temperature dimming.

Parameter "Colour temperature control type"

This parameter is for setting the control type of colour temperature. Options:

Normal(with 2byte absolute value)

Normal(with 1byte percentage value)

Directly(with warm/cool white algorithm)

Normal: Send value of 1 byte brightness and 2 byte colour temperature;

Directly(with warm/cool white algorithm): Directly control, the has been built-in "Brightness + Colour Temperature" and Warm/cool white brightness, that is 2 objects of 1 byte, which is used for output brightness adjustment to control warm white LED and cool white LED.

—Parameter "Status feedback object"

This parameter is visible when previous parameter is selected "Directly(with warm/cool white algorithm)". Set the status feedback object. Options:

Brightness+Colour Temperature

Warm/cool white brightness

Brightness+Colour Temperature: Feedback of Brightness+Colour Temperature is to communicate accurately with the data from the other panels.

Warm/cool white brightness: Feedback of Warm/cool white brightness is to communicate with actuator.

Parameter "Min. colour temperature [2000..7000]K"

Parameter "Max. colour temperature [2000..7000]K"

These parameters are for setting the upper and lower limit threshold of colour temperature.

Options: **2000..7000**

5.11.2.6.Curtain and blind control

--- KNX Smart Touch S7 > KNX Channel > Channel 1-...

Night mode setting	Function	Curtain step/move
Coordinates location setting	Function description (max 18 char.)	
Summer time setting	Function icon	Curtain
Proximity setting	Icon preview	
Extension Sub Panel setting	Device online status reference by	Individual
Advanced setting	Period for request device online status [1...255]	10 min
Home page		
Display view		
Area 1-...		

Curtain step/move

--- KNX Smart Touch S7 > KNX Channel > Channel 1-...

Night mode setting	Function	Roller blind step/move
Coordinates location setting	Function description (max 18 char.)	
Summer time setting	Function icon	Roller blind
Proximity setting	Icon preview	
Extension Sub Panel setting	Device online status reference by	Individual
Advanced setting	Period for request device online status [1...255]	10 min
Home page		
Display view		
Area 1-...		

Roller blind step/move

15.15.201 KNX Smart Touch S7 > KNX Channel > Channel 1-...

<ul style="list-style-type: none"> KNX Secure General General setting Security setting Night mode setting Coordinates location setting Summer time setting Proximity setting Extension Sub Panel setting 	<p>Function: <input type="text" value="Curtain position"/></p> <p>Function description (max 18 char.): <input type="text"/></p> <p>Function icon: <input type="text" value="Curtain"/></p> <p>Icon preview: </p> <hr/> <p>Device online status reference by: <input type="text" value="Individual"/></p> <p>Period for request device online status [1...255]: <input type="text" value="10"/> min</p>
--	--

Curtain position

--- KNX Smart Touch S7 > KNX Channel > Channel 1-...

<ul style="list-style-type: none"> Night mode setting Coordinates location setting Summer time setting Proximity setting Extension Sub Panel setting Advanced setting Home page Display view Area 1-... 	<p>Function: <input type="text" value="Roller blind position"/></p> <p>Function description (max 18 char.): <input type="text"/></p> <p>Function icon: <input type="text" value="Roller blind"/></p> <p>Icon preview: </p> <hr/> <p>Device online status reference by: <input type="text" value="Individual"/></p> <p>Period for request device online status [1...255]: <input type="text" value="10"/> min</p>
--	--

Roller blind position

15.15.201 KNX Smart Touch S7 > KNX Channel > Channel 1-...

Summer time setting	Function	Venetian blind position and slat
Proximity setting	Function description (max 18 char.)	
Extension Sub Panel setting	Function icon	Venetian blind
Advanced setting	Icon preview	
Home page	Device online status reference by	Individual
+ Display view	Period for request device online status [1...255]	10 min
- KNX Channel		
Channel 1-...		
+ KNX Scene		

Venetian blind position and slat

Fig.5.11.2(6) "Curtain and blind control" parameter window

Parameter "Device online status reference by"

This parameter is for setting the reference type for sending read requests to KNX devices on the bus. Options:

Individual

Common 1

...

Common 10

Always online

Note:(Press/Release switch and value transmission, read-only display "Always online".)

—Parameter "Period for request device online status [1..255] min"

This parameter is visible when previous parameter is selected "Individual". Set the time period for individual device online status requests. Options: **0...255**

5.11.2.7. Air conditioner control

15.15.201 KNX Smart Touch S7 > KNX Channel > Channel 1-...

<ul style="list-style-type: none"> KNX Secure General <ul style="list-style-type: none"> General setting Security setting Night mode setting Coordinates location setting Summer time setting Proximity setting Extension Sub Panel setting Advanced setting Home page Display view KNX Channel <ul style="list-style-type: none"> Channel 1-... KNX Scene Internal temperature meas... HVAC controller <ul style="list-style-type: none"> Controller 1-... Weekly timer function 	<p>Function: Air conditioner</p> <p>Function description (max 18 char.):</p> <p>Function icon: Air conditioner 1</p> <p>Icon preview: </p> <hr/> <p>Device online status reference by: Individual</p> <p>Period for request device online status [1...255]: 10 min</p> <hr/> <p>Interface display temperature: <ul style="list-style-type: none"> <input type="radio"/> Setpoint temperature <input checked="" type="radio"/> Actual temperature </p> <p>Room temperature reference from: <ul style="list-style-type: none"> <input type="radio"/> Internal sensor <input checked="" type="radio"/> External sensor </p> <p>Period for request external sensor [0...255]: 10 min</p> <hr/> <p>Object datatype of setpoint: <ul style="list-style-type: none"> <input checked="" type="radio"/> Value in °C (DPT_5.010) <input type="radio"/> Float value in °C (DPT_9.001) </p> <p>Setpoint temperature adjustment step: 1K</p> <p>Min. setpoint temperature [16...32]: 16 °C</p> <p>Max. setpoint temperature [16...32]: 32 °C</p> <hr/> <p>Timer: <input checked="" type="checkbox"/></p> <hr/> <p>Protection setting</p> <ul style="list-style-type: none"> ON/OFF protection: <input type="checkbox"/> Setpoint protection: <input type="checkbox"/> Control mode protection: <input type="checkbox"/> Fan protection: <input type="checkbox"/>
---	--

Air conditioner(External sensor)

<ul style="list-style-type: none"> - General General setting Security setting Night mode setting Coordinates location setting Summer time setting Proximity setting Extension Sub Panel setting Advanced setting Home page + Display view - KNX Channel + Channel 1... + KNX Scene Internal temperature meas... - HVAC controller - Controller 1... Setpoint Heating/Cooling control Fan auto.control Human Centric Lighting(H... 	Function	Air conditioner(with swing)
	Function description (max 18 char.)	
	Function icon	Air conditioner 2
	Icon preview	
	Device online status reference by	Individual
	Period for request device online status [1...255]	10 min
	Interface display temperature	<input type="radio"/> Setpoint temperature <input checked="" type="radio"/> Actual temperature
	Room temperature reference from	<input checked="" type="radio"/> Internal sensor <input type="radio"/> External sensor
	Object datatype of setpoint	<input checked="" type="radio"/> Value in °C (DPT_5.010) <input type="radio"/> Float value in °C (DPT_9.001)
	Setpoint temperature adjustment step	1K
	Min. setpoint temperature [16...32]	16 °C
	Max. setpoint temperature [16...32]	32 °C
	Timer	<input checked="" type="checkbox"/>
	Protection setting	
	ON/OFF protection	<input type="checkbox"/>
Setpoint protection	<input type="checkbox"/>	
Control mode protection	<input type="checkbox"/>	
Fan protection	<input type="checkbox"/>	
Vanes swing protection	<input type="checkbox"/>	

Air conditioner(with swing)

Fig.5.11.2(7) "Air conditioner control"parameter window

Parameter "Interface display temperature"

This parameter is for setting the interface display temperature under the normal status. Options:

Setpoint temperature

Actual temperature

Note: If display room temperature, only switch to display setpoint temperature when firstly operate temperature increase/decrease button, and not send telegram.

—Parameter "Room temperature reference from"

Setting the resource of the air condition function temperature reference. Options:

Internal sensor

External sensor

—Parameter "Period for request external sensor [0...255]min"

This parameter is visible when "External sensor" is selected. Set the time period for read request external temperature sensor. Options: **0..255**

Note: Send read request as default when the device voltage recovery.

Parameter "Object datatype of setpoint"

This parameter is for setting the object datatype of setpoint temperature. Options:

Value in °C (DPT_5.010)

Float value in °C (DPT_9.001)

Parameter "Setpoint temperature adjustment step"

This parameter is for setting step value of setpoint temperature. Options display according to datatype:

0.5K

1K

When select "Value in °C (DPT_5.010)", only **1K**

Parameter "Min/Max. setpoint temperature [16..32]°C"

These parameters are for setting the adjustable range of the setpoint temperature, the minimum value should be less than the maximum value. If the setpoint temperature beyond the limited range, will output the limited temperature. Options:

16°C

17°C

...

32°C

Parameter "Timer"

This parameter is for setting whether to enable timer function, display corresponding object when enable. User can set the time on the screen.

Note: The bus only disable timer function temporarily.

Protection setting

Parameter "ON/OFF protection"

Parameter "Setpoint protection"

Parameter "Mode protection"

Parameter "Fan protection"

Parameter "Vanes swing protection"

The parameter "Vanes swing protection" is displayed when the function "Air conditioner (with swing)" is selected.

These parameters are for setting to whether to enable protection function, that is some functions only display and not allow user to operate. Protection function support to ON/OFF, setpoint value, mode, fan speed control, swing control.

For protection function, user can not operate screen or shortcut button, but still process received status.

5.11.2.8. Room temperature unit control

15.15.201 KNX Smart Touch S7 > KNX Channel > Channel 1-...

<ul style="list-style-type: none"> KNX Secure General <ul style="list-style-type: none"> General setting Security setting Night mode setting Coordinates location setting Summer time setting Proximity setting Extension Sub Panel setting Advanced setting Home page Display view KNX Channel <ul style="list-style-type: none"> Channel 1-... KNX Scene Internal temperature meas... HVAC controller <ul style="list-style-type: none"> Controller 1-... Weekly timer function 	<p>Function: Room temperature unit</p> <p>Function description (max 18 char.):</p> <p>Function icon: Heating/Cooling</p> <p>Icon preview: </p> <hr/> <p>Device online status reference by: Individual</p> <p>Period for request device online status [1...255]: 10 min</p> <hr/> <p>Controller from: <input checked="" type="radio"/> Local <input type="radio"/> Bus</p> <p>Interface display temperature: <input type="radio"/> Setpoint temperature <input checked="" type="radio"/> Actual temperature</p> <p>Room temperature reference from: <input type="radio"/> Internal sensor <input checked="" type="radio"/> External sensor</p> <p>Period for request external sensor [0...255]: 10 min</p> <hr/> <p>Object datatype of setpoint adjustment: <input type="radio"/> 1bit (DPT_1.007) <input checked="" type="radio"/> 2byte (DPT_9.001)</p> <p>Setpoint temperature adjustment step: <input checked="" type="radio"/> 0.5K <input type="radio"/> 1K</p> <p>Min. setpoint temperature [5...37]: 10 °C</p> <p>Max. setpoint temperature [5...37]: 32 °C</p> <hr/> <p>Control mode: Heating</p> <p>Timer: <input type="checkbox"/></p> <hr/> <p>Protection setting</p> <p>Setpoint protection: <input type="checkbox"/></p>
---	--

Room temperature unit(External sensor)

15.15.201 KNX Smart Touch S7 > KNX Channel > Channel 1-...

KNX Secure

General

General setting

Security setting

Night mode setting

Coordinates location setting

Summer time setting

Proximity setting

Extension Sub Panel setting

Advanced setting

Home page

Display view

KNX Channel

Channel 1-...

KNX Scene

Internal temperature meas...

HVAC controller

Controller 1-...

Weekly timer function

HVAC controller

Controller 1-...

Function Room temperature unit(with on/off) ▼

Function description (max 18 char.)

Function icon Heating/Cooling ▼

Icon preview

Device online status reference by Individual ▼

Period for request device online status [1...255] 10 min

Controller from Local Bus

Interface display temperature Setpoint temperature Actual temperature

Room temperature reference from Internal sensor External sensor

Period for request external sensor [0...255] 10 min

Power on/off after download OFF ON

Power on/off after voltage recovery Before voltage failure ▼

Object datatype of setpoint adjustment 1bit (DPT_1.007) 2byte (DPT_9.001)

Setpoint temperature adjustment step 0.5K 1K

Min. setpoint temperature [5...37] 10 °C

Max. setpoint temperature [5...37] 32 °C

Control mode Heating ▼

Timer

Protection setting

ON/OFF protection

Setpoint protection

Room temperature unit(with on/off)-External sensor

15.15.201 KNX Smart Touch S7 > KNX Channel > Channel 1-...

KNX Secure

General

General setting

Security setting

Night mode setting

Coordinates location setting

Summer time setting

Proximity setting

Extension Sub Panel setting

Advanced setting

Home page

Display view

KNX Channel

Channel 1-...

KNX Scene

Internal temperature meas...

HVAC controller

Controller 1-...

Weekly timer function

Function: Room temperature unit(with operation mode)

Function description (max 18 char.):

Function icon: Heating/Cooling

Icon preview: 

Device online status reference by: Individual

Period for request device online status [1...255]: 10 min

Controller from: Local Bus

Interface display temperature: Setpoint temperature Actual temperature

Room temperature reference from: Internal sensor External sensor

Period for request external sensor [0...255]: 10 min

Object datatype of setpoint adjustment: 1bit (DPT_1.007) 2byte (DPT_9.001)

Setpoint temperature adjustment step: 0.5K 1K

Min. setpoint temperature [5...37]: 10 °C

Max. setpoint temperature [5...37]: 32 °C

Control mode: Heating

Timer:

Protection setting

Setpoint protection:

Operation mode protection:

Room temperature unit(with operation mode)-External sensor

15.15.201 KNX Smart Touch S7 > KNX Channel > Channel 1-...

KNX Secure

General

General setting

Security setting

Night mode setting

Coordinates location setting

Summer time setting

Proximity setting

Extension Sub Panel setting

Advanced setting

Home page

Display view

KNX Channel

Channel 1-...

KNX Scene

Internal temperature meas...

HVAC controller

Controller 1-...

Weekly timer function

Function: Room temperature unit(with on/off & operation mode)

Function description (max 18 char.):

Function icon: Heating/Cooling

Icon preview: 

Device online status reference by: Individual

Period for request device online status [1...255]: 10 min

Controller from: Local Bus

Interface display temperature: Setpoint temperature Actual temperature

Room temperature reference from: Internal sensor External sensor

Period for request external sensor [0...255]: 10 min

Power on/off after download: OFF ON

Power on/off after voltage recovery: Before voltage failure

Object datatype of setpoint adjustment: 1bit (DPT_1.007) 2byte (DPT_9.001)

Setpoint temperature adjustment step: 0.5K 1K

Min. setpoint temperature [5...37]: 10 °C

Max. setpoint temperature [5...37]: 32 °C

Control mode: Heating

Timer:

Protection setting

ON/OFF protection:

Setpoint protection:

Operation mode protection:

Room temperature unit(with on/off & operation mode)-External sensor

15.15.201 KNX Smart Touch S7 > KNX Channel > Channel 1-...

- KNX Secure
- General
 - General setting
 - Security setting
 - Night mode setting
 - Coordinates location setting
 - Summer time setting
 - Proximity setting
 - Extension Sub Panel setting
 - Advanced setting
- Home page
- Display view
- KNX Channel
 - + Channel 1-...**
 - + KNX Scene
 - Internal temperature meas...
 - HVAC controller
 - Controller 1-...
 - + Weekly timer function
 - HVAC controller
 - Controller 1-...
 - + Weekly timer function

Function Room temperature unit(with operation mode & fan speed) ▾

Function description (max 18 char.)

Function icon Heating/Cooling ▾

Icon preview

Device online status reference by Individual ▾

Period for request device online status [1...255] min

Controller from Local Bus

Interface display temperature Setpoint temperature Actual temperature

Room temperature reference from Internal sensor External sensor

Period for request external sensor [0...255] min

Object datatype of setpoint adjustment 1bit (DPT_1.007) 2byte (DPT_9.001)

Setpoint temperature adjustment step 0.5K 1K

Min. setpoint temperature [5...37] °C

Max. setpoint temperature [5...37] °C

Control mode Heating ▾

Timer

Protection setting

Setpoint protection

Operation mode protection

Fan protection

Room temperature unit(with operation mode & fan speed)-External sensor

<p>KNX Secure</p> <p>General</p> <ul style="list-style-type: none"> General setting Security setting Night mode setting Coordinates location setting Summer time setting Proximity setting Extension Sub Panel setting Advanced setting <p>Home page</p> <p>Display view</p> <p>KNX Channel</p> <p>Channel 1...</p> <p>KNX Scene</p> <p>Internal temperature meas...</p> <p>HVAC controller</p> <p>Controller 1...</p> <p>Weekly timer function</p> <p>KNX Scene</p> <p>Internal temperature meas...</p> <p>HVAC controller</p> <p>Controller 1...</p>		<p>Function: Room temperature unit(with on/off & operation mode & fan speed)</p> <p>Function description (max 18 char.):</p> <p>Function icon: Heating/Cooling</p> <p>Icon preview: </p> <hr/> <p>Device online status reference by: Individual</p> <p>Period for request device online status [1...255]: 10 min</p> <hr/> <p>Controller from: <input checked="" type="radio"/> Local <input type="radio"/> Bus</p> <p>Interface display temperature: <input type="radio"/> Setpoint temperature <input checked="" type="radio"/> Actual temperature</p> <p>Room temperature reference from: <input type="radio"/> Internal sensor <input checked="" type="radio"/> External sensor</p> <p>Period for request external sensor [0...255]: 10 min</p> <hr/> <p>Power on/off after download: <input type="radio"/> OFF <input checked="" type="radio"/> ON</p> <p>Power on/off after voltage recovery: Before voltage failure</p> <hr/> <p>Object datatype of setpoint adjustment: <input type="radio"/> 1bit (DPT_1.007) <input checked="" type="radio"/> 2byte (DPT_9.001)</p> <p>Setpoint temperature adjustment step: <input checked="" type="radio"/> 0.5K <input type="radio"/> 1K</p> <p>Min. setpoint temperature [5...37]: 10 °C</p> <p>Max. setpoint temperature [5...37]: 32 °C</p> <hr/> <p>Control mode: Heating</p> <p>Timer: <input type="checkbox"/></p> <hr/> <p>Protection setting</p> <p>ON/OFF protection: <input type="checkbox"/></p> <p>Setpoint protection: <input type="checkbox"/></p> <p>Operation mode protection: <input type="checkbox"/></p> <p>Fan protection: <input type="checkbox"/></p>
---	--	---

Room temperature unit(with on/off & operation mode & fan speed)-External sensor

Fig.5.11.2(8) "Room temperature unit control"parameter window

15.15.201 KNX Smart Touch S7 > KNX Channel > Channel 1-... > Fan

- Coordinates location setting
- Summer time setting
- Proximity setting
- Extension Sub Panel setting
- Advanced setting
- Home page
- + Display view
- KNX Channel
- Channel 1-...
- Fan

Object datatype of 1byte fan speed
 Fan stage (DPT_5.100)
 Percentage (DPT_5.001)

Output value for fan speed

Output value for fan speed low %

Output value for fan speed medium %

Output value for fan speed high %

Status feedback for fan speed

Status value for fan speed low %

Status value for fan speed medium %

Status value for fan speed high %

Automatic operation function

Fig.5.11.2(9) "Fan"parameter window

Parameter "Controller from"

This parameter is for setting the controller is from the local or bus. If select the local controller, it no need to send the read request of the setting temperature, control mode and operation mode when power on or bus recovery (because the device cannot respond to its own request). Options:

Local

Bus

Parameter "Interface display temperature"

This parameter is for setting the interface display temperature under the normal status. Options:

Setpoint temperature

Actual temperature

Note: If display room temperature, only switch to display setpoint temperature when firstly operate temperature increase/decrease button, and not send telegram.

—Parameter "Room temperature reference from"

This parameter is visible when "Actual temperature" is selected. Set the resource of the temperature reference. Options:

Internal sensor

External sensor

—Parameter “Period for request external sensor [0...255]min”

This parameter is visible when “External sensor” is selected. Set the time period for read request external temperature sensor. Options: **0..255**

Note: Send read request as default when the device voltage recovery.

Parameter “Object datatype of setpoint adjustment”

This parameter is for setting the object datatype of setpoint temperature. Options:

1bit (DPT_1.007)

2byte (DPT_9.001)

Parameter “Setpoint temperature adjustment step”

This parameter is visible when “2byte (DPT_9.001 ” is selected. Set the step value of setpoint temperature. Options:

0.5K

1K

Parameter “Min/Max. setpoint temperature [5..37]°C”

These parameters are for setting the adjustable range of the setpoint temperature, the minimum value should be less than the maximum value. If the setpoint temperature beyond the limited range, the will output the limited temperature.

Options: **5...37**

Parameter “Control mode”

This parameter is for setting the RTC control mode. Options:

Heating

Cooling

Heating and Cooling

Parameter "Timer"

This parameter is for setting whether to enable timer function, display corresponding object when enable. User can set the time on the screen.

Note: The bus only disable timer function temporarily.

Protection setting**Parameter "ON/OFF protection"****Parameter "Setpoint protection"****Parameter "Control mode protection"****Parameter "Operation mode protection"****Parameter "Fan protection"**

These parameters are for setting to whether to enable protection function, that is some functions only display and not allow user to operate. Protection function support to ON/OFF, setpoint value, control mode, operation mode, fan speed control.

For protection function, user can not operate screen or shortcut button, but still process received data.

Note: The display conditions for this part of the parameter

1. The parameters of ON/OFF protection will only be displayed for temperature control types with ON/OFF.

2. Control mode protection is visible when Heating and Cooling is selected;

3. Temperature control type with operation mode will only show the parameters of operation mode protection.

4. Temperature control type with fan speed will only show the parameters of Fan protection.

Parameters as follow are visible when "Room temperature unit(with on/off)" or "Room temperature unit(with on/off & operation mode)" or "Room temperature unit(with on/off & operation mode & fan speed)" is selected.

Parameter "Power on/off after download"

This parameter is for setting the power on/off status of RTC interface after download. Options:

OFF

ON

Parameter "Power on/off after voltage recovery"

This parameter is for setting the power on/off status of RTC interface after device voltage recovery. Options:

OFF 关

ON 开

Before voltage failure

OFF: Device will power off when voltage recovery, the screen can not be operated, except for the power icon.

ON: Device will power on when voltage recovery, the screen can be operated;

Before voltage failure: Device will return to the power status as before voltage failure when voltage recovery.

Parameters as follow are visible when "Room temperature unit(with operation mode & fan speed)" is selected. Shown as Fig.5.11.2.1(8)

Parameter "Object datatype of 1byte fan speed"

This parameter is for setting the object datatype of 1 byte fan speed. Options:

Fan stage (DPT 5.100)

Percentage (DPT 5.001)

Output value for fan speed

Parameter "Output value for fan speed low/medium/high"

These three parameters are for setting the value sent for each fan speed switchover, support 3 fan speeds low, medium, high. Options according to fan object datatype: **0..255/0..100**

Status feedback for fan speed

Parameter "Status value for fan speed low/medium/high"

These parameters are for setting the status feedback value for each fan speed, support 3 fan speeds low, medium, high. Device updates display according to feedback value. Options according to fan object datatype: **0..255/0..100**

Parameter "Automatic operation function"

This parameter is for setting whether to enable fan speed auto function, display corresponding object when enable.

5.11.2.9. Ventilation system control

15.15.201 KNX Smart Touch S7 > KNX Channel > Channel 1-...

<ul style="list-style-type: none"> Summer time setting Proximity setting Extension Sub Panel setting Advanced setting 	<p>Function: <input type="text" value="Ventilation system"/></p> <p>Function description (max 18 char.): <input type="text"/></p> <p>Function icon: <input type="text" value="Ventilation"/></p> <p>Icon preview: </p>
<ul style="list-style-type: none"> Home page Display view KNX Channel 	<p>Device online status reference by: <input type="text" value="Individual"/></p> <p>Period for request device online status [1...255]: <input type="text" value="10"/> min</p>
<ul style="list-style-type: none"> Channel 1-... KNX Scene Internal temperature meas... HVAC controller Controller 1-... <ul style="list-style-type: none"> Setpoint Heating/Cooling control Fan auto.control Human Centric Lighting(H... Weekly timer function Alarm function <ul style="list-style-type: none"> Alarm 1-... Alarm 2-... Alarm 3-... Alarm 4-... Alarm 5-... 	<p>Power on/off after download: <input type="radio"/> OFF <input checked="" type="radio"/> ON</p> <p>Power on/off after voltage recovery: <input type="text" value="Before voltage failure"/></p> <p>Default fan speed after ventilation on: <input type="text" value="Low"/></p> <p>Object datatype of 1byte fan speed: <input checked="" type="radio"/> Fan stage (DPT_5.100) <input type="radio"/> Percentage (DPT_5.001)</p> <p>Output value for fan speed</p> <p>Output value for fan speed low: <input type="text" value="1"/></p> <p>Output value for fan speed medium: <input type="text" value="2"/></p> <p>Output value for fan speed high: <input type="text" value="3"/></p> <p>Status feedback for fan speed</p> <p>Status value for fan speed low: <input type="text" value="1"/></p> <p>Status value for fan speed medium: <input type="text" value="2"/></p> <p>Status value for fan speed high: <input type="text" value="3"/></p> <p>Heat recovery function: <input checked="" type="checkbox"/></p> <p>Filter timer counter: <input checked="" type="checkbox"/></p> <p>Evaluation time [100...10000]: <input type="text" value="1000"/> h</p>

Ventilation system

15.15.201 KNX Smart Touch S7 > KNX Channel > Channel 1-...

<ul style="list-style-type: none"> KNX Secure General <ul style="list-style-type: none"> General setting Security setting Night mode setting Coordinates location setting Summer time setting Proximity setting Extension Sub Panel setting Advanced setting Home page Display view KNX Channel <ul style="list-style-type: none"> Channel 1-... KNX Scene Internal temperature meas... HVAC controller <ul style="list-style-type: none"> Controller 1-... Weekly timer function 	<p>Function: Ventilation system(with auto fan speed)</p> <p>Function description (max 18 char.):</p> <p>Function icon: Ventilation</p> <p>Icon preview: </p> <hr/> <p>Device online status reference by: Always online</p> <hr/> <p>Power on/off after download: <input type="radio"/> OFF <input checked="" type="radio"/> ON</p> <p>Power on/off after voltage recovery: Before voltage failure</p> <p>Default fan speed after ventilation on: Low</p> <hr/> <p>Object datatype of 1byte fan speed: <input type="radio"/> Fan stage (DPT_5.100) <input checked="" type="radio"/> Percentage (DPT_5.001)</p> <p>Output value for fan speed</p> <p>Output value for fan speed low: 33 %</p> <p>Output value for fan speed medium: 67 %</p> <p>Output value for fan speed high: 100 %</p> <p>Status feedback for fan speed</p> <p>Status value for fan speed low: 33 %</p> <p>Status value for fan speed medium: 67 %</p> <p>Status value for fan speed high: 100 %</p> <hr/> <p>Heat recovery function: <input checked="" type="checkbox"/></p> <p>Filter timer counter: <input checked="" type="checkbox"/></p> <p>Evaluation time [100...10000]: 1000 h</p> <hr/> <p>Air Quality value reference from: PM2.5</p> <p>Object datatype of PM2.5: <input checked="" type="radio"/> Value in ug/m3(DPT_7.001) <input type="radio"/> Float value in ug/m3(DPT_9.030)</p>
---	--

Ventilation system(with auto fan speed)

Fig.5.11.2(10) "Ventilation system control"parameter window

Parameter "Power on/off after download"

This parameter is for setting the power on/off status of ventilation system interface after download. Options:

OFF

ON

Parameter "Power on/off after voltage recovery"

This parameter is for setting the power on/off status of ventilation system interface after device voltage recovery. Options:

OFF 关

ON 开

Before voltage failure

OFF: Device will power off when voltage recovery, screen can not be operated, except for the icons of filter reset and power;

ON: Device will power on when voltage recovery, screen can be operated;

Before voltage failure: Device will return to the power status as before voltage failure when voltage recovery.

Parameter "Default fan speed after ventilation on"

This parameter is for setting the initial fan speed after power on. Options:

Low

Medium

High

Last status

Parameter "Object datatype of 1byte fan speed"

This parameter is for setting the object datatype of 1 byte fan speed. Options:

Fan stage (DPT 5.100)

Percentage (DPT 5.001)

Output value for fan speed

Parameter "Output value for fan speed low/medium/high"

These three parameters are for setting the value sent for each fan speed switchover, support 3 fan speeds low, medium, high. Options according to fan object datatype: **0..255/0..100**

Status feedback for fan speed

Parameter "Status value for fan speed low/medium/high"

These parameters are for setting the status feedback value for each fan speed, support 3 fan speeds low, medium, high. Device updates display according to feedback value. Options according to fan object datatype: **0..255/0..100**

Parameter "Heat recovery function"

This parameter is for setting whether to enable heat recovery function, display corresponding object when enable.

Parameter "Filter timer counter"

This parameter is for setting whether to enable filter timer function, display corresponding object and parameter when enable.

—Parameter "Evaluation time [100..10000]h"

This parameter is for setting the service life of the filter. Options: **100..10000**

If the filter takes longer than the setting time, the filter will send an alarm and prompt to clean the filter.

The life of the filter can be reset through the object "Filter timer reset".

The life of the filter can be counted by the object "Filter timer counter". The counting duration is in hours. The counting value will be sent to the bus when it has changed, and the counting duration of filter can be modified by object "Filter timer counter change" through the bus.

Parameter "Air Quality value reference from"

This parameter sets the sensor value that is displayed during automatic operation. Options

PM2.5

CO2

VOC

Parameter: Object datatype of PM2.5'

This parameter is for setting the data type of PM2.5. Options:

Value in ug/m3(DPT_7.001)

Float value in ug/m3(DPT_9.030)

Parameter: Object datatype of VOC'

This parameter is for setting the data type of VOC. Options:

Value in ug/m3(DPT_7.001)

Float value in ug/m3(DPT_9.030)

Parameter: Object datatype of CO2'

This parameter is for setting the data type of CO2. Options:

Value in ppm(DPT_7.001)

Float value in ppm(DPT_9.008)

5.11.2.10.Audio control

15.15.201 KNX Smart Touch S7 > KNX Channel > Channel 1-...

<ul style="list-style-type: none"> KNX Secure General <ul style="list-style-type: none"> General setting Security setting Night mode setting Coordinates location setting Summer time setting Proximity setting Extension Sub Panel setting Advanced setting Home page Display view KNX Channel 	Function	Audio control
	Function description (max 18 char.)	
	Function icon	Music 1
	Icon preview	
	Device online status reference by	Always online
	Number of object for play/pause control	<input checked="" type="radio"/> 1 <input type="radio"/> 2
	Number of object for next/previous track control	<input checked="" type="radio"/> 1 <input type="radio"/> 2
	Object datatype of volume	<input checked="" type="radio"/> Percentage (DPT_5.001) <input type="radio"/> Percentage (DPT_5.004)
	Max. volume value [10...100]	100 %
	Mute	<input checked="" type="checkbox"/>

Audio control

--- KNX Smart Touch S7 > KNX Channel > Channel 1-...

<ul style="list-style-type: none"> KNX Secure General <ul style="list-style-type: none"> General setting Security setting Night mode setting Coordinates location setting Summer time setting Proximity setting Extension Sub Panel setting Advanced setting Home page Display view KNX Channel 	Function	Audio control(with on/off)
	Function description (max 18 char.)	
	Function icon	Music 1
	Icon preview	
	Device online status reference by	Common 2
	Power on/off status after download	<input checked="" type="radio"/> OFF <input type="radio"/> ON
	Power on/off status after voltage recovery	Before voltage failure
	Number of object for play/pause control	<input checked="" type="radio"/> 1 <input type="radio"/> 2
	Number of object for next/previous track control	<input checked="" type="radio"/> 1 <input type="radio"/> 2
	Mute	<input type="checkbox"/>

Audio control(with on/off)

--- KNX Smart Touch S7 > KNX Channel > Channel 1-...

- KNX Secure
- General
- General setting
- Security setting
- Night mode setting
- Coordinates location setting
- Summer time setting
- Proximity setting
- Extension Sub Panel setting
- Advanced setting
- Home page
- Display view
- KNX Channel
- Channel 1-...
- Channel 2-...
- Channel 3-...
- Channel 4-...
- Channel 5-...
- Channel 6-...
- KNX Scene

Function Audio control(play mode) ▼

Function description (max 18 char.)

Function icon Music 1 ▼

Icon preview 

Device online status reference by Common 2 ▼

Number of object for play/pause control 1 2

Number of object for next/previous track control 1 2

Mute

Play mode setting

Play in single cycle mode

Output value for play in single cycle 1 ▼

Status value for play in single cycle 1 ▼

Play in order mode

Output value for play in order 2 ▼

Status value for play in order 2 ▼

Play in random mode

Output value for play in random 3 ▼

Status value for play in random 3 ▼

Audio control(play mode)

--- KNX Smart Touch S7 > KNX Channel > Channel 1---

KNX Secure

General

General setting

Security setting

Night mode setting

Coordinates location setting

Summer time setting

Proximity setting

Extension Sub Panel setting

Advanced setting

Home page

Display view

KNX Channel

Function: Audio control(track information)

Function description (max 18 char.):

Function icon: Music 1

Icon preview: 

Device online status reference by: Common 2

Number of object for play/pause control: 1 2

Number of object for next/previous track control: 1 2

Object datatype of volume: Percentage (DPT_5,001) Percentage (DPT_5,004)

Max. volume value [10...100]: 100 %

Mute:

Audio control(track information)

--- KNX Smart Touch S7 > KNX Channel > Channel 1---

KNX Secure

General

General setting

Security setting

Night mode setting

Coordinates location setting

Summer time setting

Proximity setting

Extension Sub Panel setting

Advanced setting

Home page

Display view

KNX Channel

Function: Audio control(track information & playlist)

Function description (max 18 char.):

Function icon: Music 1

Icon preview: 

Device online status reference by: Common 2

Number of object for play/pause control: 1 2

Number of object for next/previous track control: 1 2

Object datatype of volume: Percentage (DPT_5,001) Percentage (DPT_5,004)

Max. volume value [10...100]: 100 %

Mute:

Audio control(track information+playlist)

Fig.5.11.2(11) "Audio control"parameter window

Parameter "Number of object for play/pause control"

This parameter is for setting the number of objects that control play/pause, 1 common object or 2 separate objects. Options:

1

2

Parameter "Number of object for next/previous track control"

This parameter is for setting the number of objects that control next/previous track, 1 common object or 2 separate objects. Options:

1

2

Parameter "Mute"

This parameter is visible when 1 bit is selected. Set whether to enable mute function.

Parameters as follow are visible when "Audio control(with on/off)" is selected.

Parameter "Power on/off status after download"

This parameter is for setting the power on/off status of audio control interface after download.

Options:

OFF

ON

Parameter "Power on/off status after voltage recovery"

This parameter is for setting the power on/off status of audio control interface after device voltage recovery. Options:

OFF

ON

Before voltage failure

OFF: Device will power off when voltage recovery, screen can not be operated;

ON: Device will power on when voltage recovery, screen can be operated;

Before voltage failure: Device will return to the power status as before voltage failure when voltage recovery.

Parameters as follow are visible when "Audio control/Audio control(track information)/Audio control(track information+playlist)" is selected.

Parameter " Object datatype of volume"

This parameter is for setting the object datatype of volume. Options:

Percentage (DPT_5.001)

Percentage (DPT_5.004)

Parameter " Max. volume value [10..100]%"

This parameter is for setting the maximum volume value. Options:**10..100**

Parameters as follow are visible when"Audio control(play mode)" is selected.

Play mode setting

Parameter " Play in single cycle mode"

This parameter is for setting whether to enable play in single cycle mode. Display two parameters as follow when enable.

—Parameter"Output value for play in single cycle"

This parameter is for setting the output value for play in single cycle. Options: **0..255**

—Parameter"Status value for play in single cycle"

This parameter is for setting the status value for play in single cycle. Device will update the play mode displayed on the screen according to the feedback value. Options: **0..255**

Parameter " Play in order mode"

This parameter is for setting whether to enable play in order mode. Display two parameters as follow when enable.

—Parameter“Output value for play in order”

This parameter is for setting the output value for play in order. Options: **0..255**

—Parameter“Status value for play in order”

This parameter is for setting the status value for play in order. Device will update the play mode displayed on the screen according to the feedback value. Options: **0..255**

Parameter“ Play in random mode”

This parameter is for setting whether to enable play in random mode. Display two parameters as follow when enable.

—Parameter“Output value for play in random”

This parameter is for setting the output value for play in random. Options: **0..255**

—Parameter“Status value for play in random”

This parameter is for setting the status value for play in random. Device will update the play mode displayed on the screen according to the feedback value. Options: **0..255**

5.11.2.11. Energy metering value display

Parameter window “Energy Metering display” as shown as Fig.5.11.2(12), for setting the function of energy metering display, current, voltage, power and energy can be set to display.

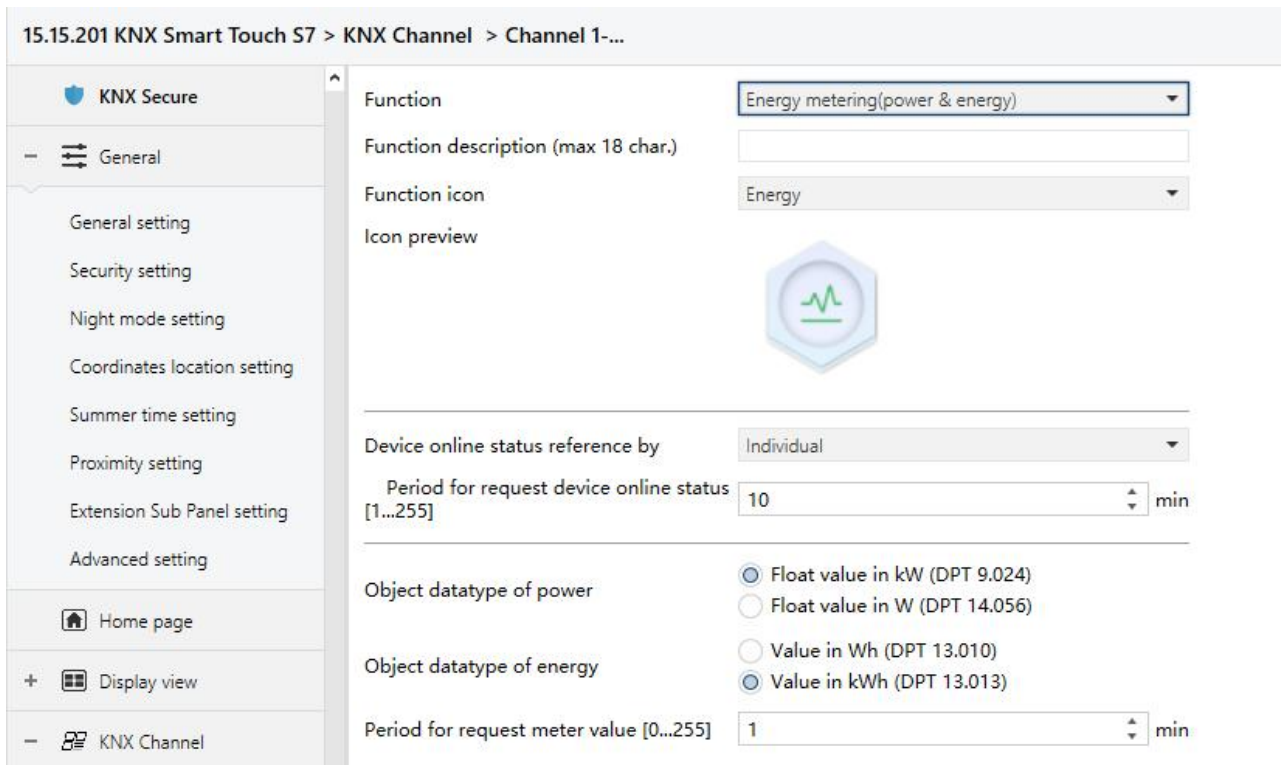

Energy metering(power & energy)

--- KNX Smart Touch S7 > KNX Channel > Channel 1-...

<ul style="list-style-type: none"> KNX Secure + General Home page + Display view - KNX Channel 	<p>Function: Energy metering(power & energy & current)</p> <p>Function description (max 18 char.):</p> <p>Function icon: Energy</p> <p>Icon preview:</p> 
<ul style="list-style-type: none"> Channel 1-... Channel 2-... Channel 3-... Channel 4-... Channel 5-... Channel 6-... + KNX Scene 	<p>Device online status reference by: Common 2</p> <p>Object datatype of current: Float value in mA (DPT 9.021)</p> <p>Object datatype of power: <ul style="list-style-type: none"> <input checked="" type="radio"/> Float value in kW (DPT 9.024) <input type="radio"/> Float value in W (DPT 14.056) </p> <p>Object datatype of energy: <ul style="list-style-type: none"> <input type="radio"/> Value in Wh (DPT 13.010) <input checked="" type="radio"/> Value in kWh (DPT 13.013) </p> <p>Period for request meter value [0...255]: 0 min</p>

Energy metering(power & energy & current)

--- KNX Smart Touch S7 > KNX Channel > Channel 1-...

<ul style="list-style-type: none"> KNX Secure + General Home page + Display view - KNX Channel 	<p>Function: Energy metering(power & energy & current & voltage)</p> <p>Function description (max 18 char.):</p> <p>Function icon: Energy</p> <p>Icon preview:</p> 
<ul style="list-style-type: none"> Channel 1-... Channel 2-... Channel 3-... Channel 4-... Channel 5-... Channel 6-... + KNX Scene Internal temperature meas... 	<p>Device online status reference by: Common 2</p> <p>Object datatype of current: Float value in mA (DPT 9.021)</p> <p>Object datatype of voltage: <ul style="list-style-type: none"> <input type="radio"/> Float value in mV (DPT 9.020) <input checked="" type="radio"/> Float value in V (DPT 14.027) </p> <p>Object datatype of power: <ul style="list-style-type: none"> <input checked="" type="radio"/> Float value in kW (DPT 9.024) <input type="radio"/> Float value in W (DPT 14.056) </p> <p>Object datatype of energy: <ul style="list-style-type: none"> <input type="radio"/> Value in Wh (DPT 13.010) <input checked="" type="radio"/> Value in kWh (DPT 13.013) </p> <p>Period for request meter value [0...255]: 0 min</p>

Energy metering(power & energy & current & voltage)

Fig.5.11.2(12) "Energy metering value display"parameter window

Parameter "Object datatype of power"

This parameter is for setting the data type of power metering display items. Options:

Float value in kW (DPT 9.024)

Float value in W (DPT 14.056)

Parameter "Object datatype of energy"

This parameter is for setting the data type of energy metering display items. Options:

Value in Wh (DPT 13.010)

Value in kWh (DPT 13.013)

Parameter "Period for request meter value {0...255}min"

This parameter is for setting the time period for the request meter value of the device sent to external metering actuator. Options: **0...255**

Parameters as follow are visible when "Energy metering(power & energy & current) or "Energy metering(power & energy & current & voltage)" is selected.

Parameter "Object datatype of current"

This parameter is for setting the data type of current metering display items. Options:

Value in mA (DPT 7.012)

Float value in mA (DPT 9.021)

Float value in A (DPT 14.019)

Parameters as follow are visible when "Energy metering(power & energy & current & voltage)" is selected.

Parameter "Object datatype of voltage"

This parameter is for setting the data type of voltage metering display items. Options:

Float value in mV (DPT 9.020)

Float value in V (DPT 14.027)

5.11.2.12. Temperature/Humidity sensor

--- KNX Smart Touch S7 > KNX Channel > Channel 1-...

<ul style="list-style-type: none"> KNX Secure + General Home page + Display view - KNX Channel Channel 1-... Channel 2-... Channel 3-... Channel 4-... Channel 5-... Channel 6-... + KNX Scene 	Function	Temperature sensor
	Function description (max 18 char.)	
	Function icon	Temperature 1
	Icon preview	
	Device online status reference by	Common 2
	Period for request external sensor [0...255]	0 min
Alarm	<input checked="" type="checkbox"/>	
Threshold value for low temperature alarm [0...15]	0 °C	
Threshold value for high temperature alarm [30...45]	45 °C	

Temperature sensor

--- KNX Smart Touch S7 > KNX Channel > Channel 1-...

<ul style="list-style-type: none"> KNX Secure + General Home page + Display view - KNX Channel Channel 1-... Channel 2-... Channel 3-... Channel 4-... Channel 5-... Channel 6-... + KNX Scene 	Function	Humidity sensor
	Function description (max 18 char.)	
	Function icon	Humidity
	Icon preview	
	Device online status reference by	Common 2
	Period for request external sensor [0...255]	0 min
Alarm	<input checked="" type="checkbox"/>	
Threshold value for low humidity alarm [5...20]	5 %	
Threshold value for high humidity alarm [70...85]	85 %	

Humidity sensor

Fig.5.11.2(13) "Temperature/Humidity sensor"parameter window

Parameter* Alarm*

This parameter for setting the whether to enable the alarm function. Applicable to Temperature sensor, Humidity sensor, VOC, PM2.5 sensor, PM10 sensor, AQI sensor, CO2 sensor.

Parameter* Threshold for low temperature alarm [0..15]

This parameter is for setting the threshold value for low temperature alarm. When the temperature lower than low threshold, low temperature alarm object will send telegram. Options:

0°C

1°C

...

15°C

Parameter* Threshold for high temperature alarm [30..45]

This parameter is for setting the threshold value for high temperature alarm. When the temperature higher than high threshold, high temperature alarm object will send telegram. Options:

30°C

31°C

...

45°C

Parameter* Threshold for low humidity alarm [5..20]%

This parameter is for setting the threshold value for low humidity alarm. When the humidity lower than low threshold, low humidity alarm object will send telegram. Options:**5..20**

Parameter* Threshold for high humidity alarm [70..85]%

This parameter is for setting the threshold value for high humidity alarm. When the humidity higher than high threshold, high humidity alarm object will send telegram. Options:

70. .85

71.

Parameter "Period for request external sensor [0...255]min"

This parameter is for setting the time period to read external sensor, send read requests by default after bus recovery or finish programming. Options: 0..255

5.11.2.13 Air quality detected value display

Parameter window "Air Quality display" as shown as Fig.5.11.2(14), for setting the function of air quality display, temperature, humidity, PM2.5, PM10, VOC, CO2, AQI, brightness, wind speed can be set to display.

15.15.201 KNX Smart Touch S7 > KNX Channel > Channel 1-...

<ul style="list-style-type: none"> KNX Secure General <ul style="list-style-type: none"> General setting Security setting Night mode setting Coordinates location setting Summer time setting Proximity setting Extension Sub Panel setting Advanced setting Home page Display view KNX Channel <ul style="list-style-type: none"> Channel 1-... KNX Scene 	<p>Function: PM2.5 sensor</p> <p>Function description (max 18 char.):</p> <p>Function icon: PM2.5</p> <p>Icon preview: </p> <hr/> <p>Device online status reference by: Individual</p> <p>Period for request device online status [1...255]: 10 min</p> <hr/> <p>Object datatype of PM2.5: <input checked="" type="radio"/> Value in ug/m3(DPT_7.001) <input type="radio"/> Float value in ug/m3(DPT_9.030) </p> <p>Text for unit:</p> <p>Period for request external sensor [0...255]: 0 min</p> <p>Monitoring level indication: <input type="checkbox"/></p> <hr/> <p>Alarm: <input checked="" type="checkbox"/></p> <p>PM2.5 alarm value [100...999]: 150 ug/m3</p>
---	--

PM2.5 sensor

--- KNX Smart Touch S7 > KNX Channel > Channel 1-...

<ul style="list-style-type: none"> KNX Secure General Home page Display view KNX Channel 	Function	PM10 sensor
	Function description (max 18 char.)	
	Function icon	PM10
	Icon preview	
	Device online status reference by	Common 2
	Object datatype of PM10	<input checked="" type="radio"/> Value in ug/m3(DPT_7.001) <input type="radio"/> Float value in ug/m3(DPT_9.030)
	Text for unit	
	Period for request external sensor [0...255]	0 min
	Monitoring level indication	<input type="checkbox"/>
	Alarm	<input checked="" type="checkbox"/>
PM10 alarm value [100...999]	150 ug/m3	

PM10 sensor

--- KNX Smart Touch S7 > KNX Channel > Channel 1-...

<ul style="list-style-type: none"> KNX Secure General Home page Display view KNX Channel 	Function	VOC sensor
	Function description (max 18 char.)	
	Function icon	VOC
	Icon preview	
	Device online status reference by	Common 2
	Object datatype of VOC	<input checked="" type="radio"/> Value in ug/m3(DPT_7.001) <input type="radio"/> Float value in ug/m3(DPT_9.030)
	Text for unit	
	Period for request external sensor [0...255]	0 min
	Alarm	<input checked="" type="checkbox"/>
	VOC alarm value [100...900]	500 ug/m3

VOC sensor

--- KNX Smart Touch S7 > KNX Channel > Channel 1-...

<ul style="list-style-type: none"> KNX Secure + General Home page + Display view - KNX Channel Channel 1-... Channel 2-... Channel 3-... Channel 4-... Channel 5-... Channel 6-... + KNX Scene Internal temperature meas... 	Function	AQI sensor
	Function description (max 18 char.)	
	Function icon	AQI
	Icon preview	
	Device online status reference by	Common 2
	Text for unit	
	Period for request external sensor [0...255]	0 min
	Monitoring level indication	<input type="checkbox"/>
	Alarm	<input checked="" type="checkbox"/>
	AQI alarm value [100...500]	200

AQI sensor

--- KNX Smart Touch S7 > KNX Channel > Channel 1-...

<ul style="list-style-type: none"> KNX Secure + General Home page + Display view - KNX Channel Channel 1-... Channel 2-... Channel 3-... Channel 4-... Channel 5-... Channel 6-... + KNX Scene Internal temperature meas... 	Function	CO2 sensor
	Function description (max 18 char.)	
	Function icon	CO2
	Icon preview	
	Device online status reference by	Common 2
	Object datatype of CO2	<input type="radio"/> Value in ppm(DPT_7.001) <input checked="" type="radio"/> Float value in ppm(DPT_9.008)
	Text for unit	
	Period for request external sensor [0...255]	0 min
	Monitoring level indication	<input type="checkbox"/>
	Alarm	<input checked="" type="checkbox"/>
CO2 alarm value [1000...5000]	2000 ppm	

CO2 sensor

--- KNX Smart Touch S7 > KNX Channel > Channel 1-...

<ul style="list-style-type: none"> KNX Secure + General Home page + Display view - KNX Channel Channel 1-... Channel 2-... Channel 3-... Channel 4-... Channel 5-... Channel 6-... + KNX Scene Internal temperature measurem... 	Function	Wind sensor
	Function description (max 18 char.)	
	Function icon	Wind speed
	Icon preview	
	Device online status reference by	Common 2
	Object datatype of wind speed	<input checked="" type="radio"/> Float value in m/s(DPT_9.005) <input type="radio"/> Float value in km/h(DPT_9.028)
	Text for unit	
	Period for request external sensor [0...255]	0 min
	Alarm	<input checked="" type="checkbox"/>
	Wind alarm value [5...50]	20 m/s

Wind sensor

--- KNX Smart Touch S7 > KNX Channel > Channel 1-...

<ul style="list-style-type: none"> KNX Secure + General Home page + Display view - KNX Channel Channel 1-... Channel 2-... Channel 3-... Channel 4-... Channel 5-... Channel 6-... + KNX Scene Internal temperature measurem... 	Function	Brightness sensor
	Function description (max 18 char.)	
	Function icon	Brightness
	Icon preview	
	Device online status reference by	Common 2
	Object datatype of brightness(lux)	<input type="radio"/> Value in lux (DPT 7.013) <input checked="" type="radio"/> Float value in lux (DPT 9.004)
	Text for unit	
	Period for request external sensor [0...255]	0 min
	Alarm	<input type="checkbox"/>
	Alarm value [5...50]	

Brightness sensor

Fig.5.11.2(14) "Air quality detected value display"parameter window

数" Text for unit"

This parameter is for setting custom text, the unit is determined by the data point type when the default value is null.

Parameter" Period for request external sensor [0..255]min"

This parameter is for setting the time period for read request external sensor. Options:**0..255**

Parameter" Monitoring level indication"

This parameter is only visible when the functions "PM2.5 sensor", "PM10 sensor", "AQI sensor", "CO2 sensor" are selected. Sets whether enable the monitoring level indication, so that the icon displays different colors according to the change of the value.

For detailed configuration instructions, please refer to chapter 5.11.

Parameters as follow are visible when"PM2.5 sensor" is selected.

Parameter" Object datatype of PM2.5"

This parameter is for setting the data type of PM2.5. Options:

Value in ug/m3(DPT_7.001)

Float value in ug/m3(DPT_9.030)

Parameter" Alarm"

This parameter is for setting whether to enable the PM2.5 alarm.

——Parameter" **PM2.5 alarm value [100....999]ug/m3"**

This parameter is visible when the previous parameter is enabled. When the PM2.5 higher than PM2.5 threshold, PM2.5 alarm object will send telegram. Options:**100...999**

Parameters as follow are visible when "PM10 sensor" is selected.

Parameter " Object datatype of PM10"

This parameter is for setting the data type of PM10. Options:

Value in ug/m3 (DPT 7.001)

Float value in ug/m3 (DPT 9.030)

Parameter " Alarm"

This parameter is for setting whether to enable the PM10 alarm.

—Parameter " PM10 alarm value [100....999]ug/m3"

This parameter is visible when the previous parameter is enabled. When the PM10 higher than PM10 threshold, PM10 alarm object will send telegram. Options: **100...999**

Parameters as follow are visible when "VOC sensor" is selected.

Parameter " Object datatype of VOC"

This parameter is for setting the data type of VOC. Options:

Value in ug/m3 (DPT 7.001)

Float value in ug/m3 (DPT 9.030)

Parameter " Alarm"

This parameter is for setting whether to enable the VOC alarm.

—Parameter " VOC alarm value [100....900]ug/m3"

This parameter is visible when the previous parameter is enabled. When the VOC higher than VOC threshold, VOC alarm object will send telegram. Options: **100...900**

Parameters as follow are visible when "AQI sensor" is selected.

Parameter "Alarm"

This parameter is for setting whether to enable the AQI alarm.

---Parameter "AQI alarm value [100....500]"

This parameter is visible when the previous parameter is enabled. When the AQI higher than AQI threshold, AQI alarm object will send telegram. Options: **100...500**

Parameters as follow are visible when "CO2 sensor" is selected.

Parameter "Object datatype of CO2"

This parameter is for setting the data type of CO2. Options:

Value in ppm(DPT_7.001)

Float value in ppm(DPT_9.008)

Parameter "Alarm"

This parameter is for setting whether to enable the CO2 alarm.

---Parameter "CO2 alarm value [1000.....5000]ppm"

This parameter is visible when the previous parameter is enabled. When the CO2 higher than CO2 hreshold, CO2 alarm object will send telegram. Options: **1000...5000**

Parameters as follow are visible when "Brightness sensor" is selected.

Parameter "Object datatype of brightness(lux)"

This parameter is for setting the data type of brightness. Options:

Value in lux(DPT_7.013)

Float value in lux(DPT_9.004)

Parameters as follow are visible when "Wind sensor" is selected.

Parameter " Object datatype of wind speed"

This parameter is for setting the data type of wind speed. Options:

Float value in m/s(DPT_9.005)

Float value in km/h(DPT_9.028)

Parameter " Alarm"

This parameter is for setting whether to enable the wind alarm.

—Parameter " Wind alarm value [5..50]m/s"

—Parameter " Wind alarm value [20..150]km/h"

This parameter is visible when the previous parameter is enabled. When the wind higher than wind threshold, wind alarm object will send telegram. Options: **5...50/20...150**

5.11.2.14.I/O sensor

--- KNX Smart Touch S7 > KNX Channel > Channel 1-...

<ul style="list-style-type: none"> KNX Secure + General Home page + Display view - KNX Channel 	<p>Function: I/O sensor</p> <p>Function description (max 18 char.):</p> <p>Function icon: I/O signal</p> <p>Icon preview:</p> 
<ul style="list-style-type: none"> Channel 1-... Channel 2-... Channel 3-... Channel 4-... Channel 5-... Channel 6-... 	<p>Device online status reference by: Common 2</p> <p>Status text for 1-ON: ON</p> <p>Status text for 0-OFF: OFF</p> <p>Period for request external sensor [0...255]: 0 min</p>

Fig.5.11.2(15) "I/O sensor"parameter window

Parameter " Status text for 1-ON"

Parameter " Status text for 0-OFF"

This parameter is used to customize the display description of status on and off, such as for displaying occupied/unoccupied, unlock/lock, open/close the window, power on/off, etc., with 4 characters in Chinese and 12 characters in English.

Parameter " Period for request external sensor [0 ...255]min"

This parameter is for setting the time period for read request external sensor. Options:**0..255**

5.11.2.15.Value sender

--- KNX Smart Touch S7 > KNX Channel > Channel 1-...

<ul style="list-style-type: none"> KNX Secure + General Home page + Display view - KNX Channel Channel 1-... Channel 2-... Channel 3-... Channel 4-... Channel 5-... Channel 6-... - KNX Scene 	<p>Function: Value sender</p> <p>Function description (max 18 char.):</p> <p>Function icon: General light</p> <p>Icon preview: </p> <hr/> <p>Device online status reference by: Always online</p> <hr/> <p>Object type of short operation: 1bit value[ON/OFF]</p> <p>Reaction on short operation: TOGGLE</p> <hr/> <p>Object type of long operation: None</p> <hr/> <p>Icon display: <input type="radio"/> OFF <input checked="" type="radio"/> ON</p>
---	---

Fig.5.11.2(16) "Value sender"parameter window

Parameter "Object type of short operation"

Parameter "Object type of long operation"

These two parameters are for setting the sending datatype when the button is in a short / long operation.

Options:

None

1bit value[ON/OFF]

2bit/4bit value

1byte value[0..255]

2byte value[0..65535]

2byte float value

4byte value[0..4294967295]

4byte float value

—Parameter“Object datatype”

This parameter is visible when select “2bit/4bit value”. Set the datatype 2bit or 4bit. Options:

2bit value[0..3]

4bit value[0..15]

Parameter“Reaction on short operation”

Parameter“Reaction on long operation”

These two parameters are for setting the sending data value when perform short/long operation.

Value range is according to the datatype selected by previous parameter.

When select 1 bit, options:

OFF

ON

TOGGLE

When select 2bit/4bit/1byte/2byte/4byte, options:

Value 1

Alternating Value1/Value2

—Parameter“Value 1”

This parameter is visible when 2bit/4bit/1byte/2byte is selected. Set the sending value 1 when perform short/long operation. Options are according to the object datatype: **0~3 / 0..15 / 0..255 / 0..65535 / -670760~670760 / 0~4294967295 / -3.40...~3.40...**

—Parameter“Value 2”

This parameter is visible when 2bit/4bit/1byte/2byte/4byte is selected, and “Alternating Value1/Value2”. Set the sending value 2 when perform short/long operation. Options are according to the object datatype: **0~3 / 0..15 / 0..255 / 0..65535 / -670760~670760 / 0~4294967295 / -3.40...~3.40...**

Parameter“Icon display”

This parameter is for setting the indication status of the icon on the screen. Options:

OFF

ON

5.12 Parameter window "KNX Scene"

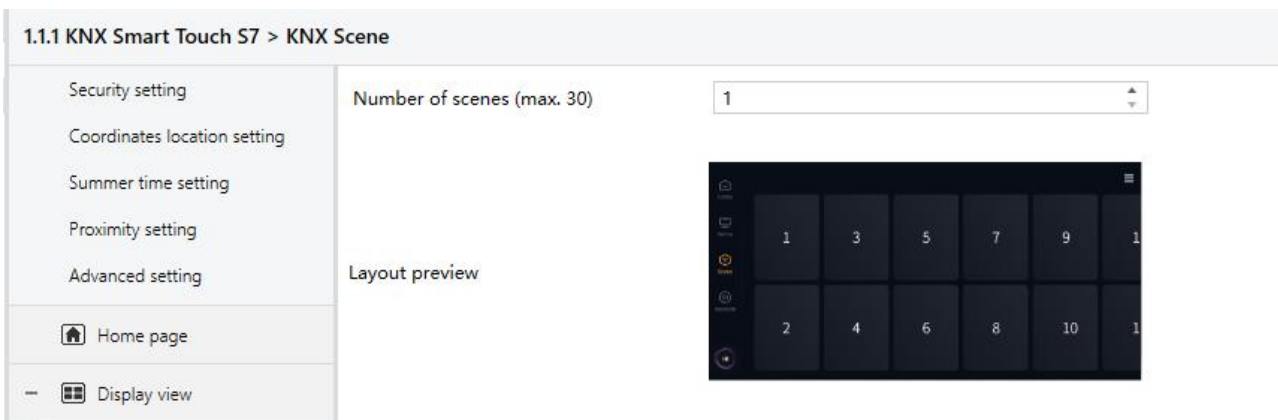

Fig.5.12(1) "KNX Scene"parameter window

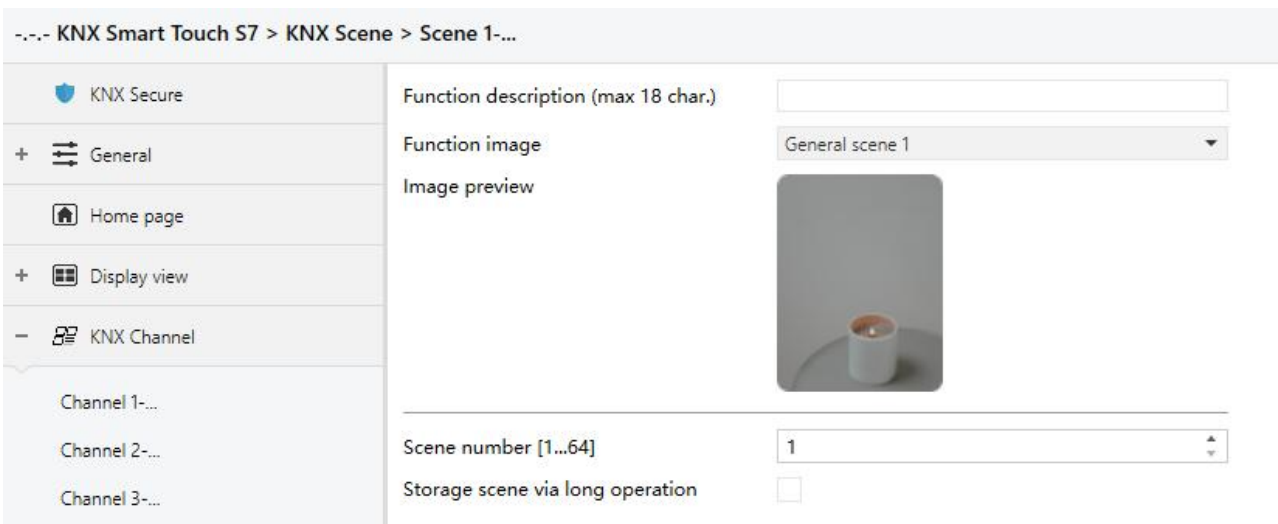

Fig.5.12(2) "Scene X"parameter window

Parameter "Number of scenes (max.30)"

This parameter is for setting the number of scenes.Options:**1...30**

Parameter "Function description (max 18char.)"

This parameter is for setting the description of scene function, up to 18 characters can be input.

Parameter "Function image"

This parameter is for setting the background image for the scene function.Options:

General scene 1

General scene 1

...

Romantic

Play

Parameter "Image preview"

This parameter displays the scene preview image.

Parameter "Scene number [1..64]"

This parameter is for setting the scene number.Options:**1...64**

Parameter "Storage scene via long operation"

This parameter is for setting whether to enable long press to save the scene.

5.13 Parameter window "Internal sensor measurement"

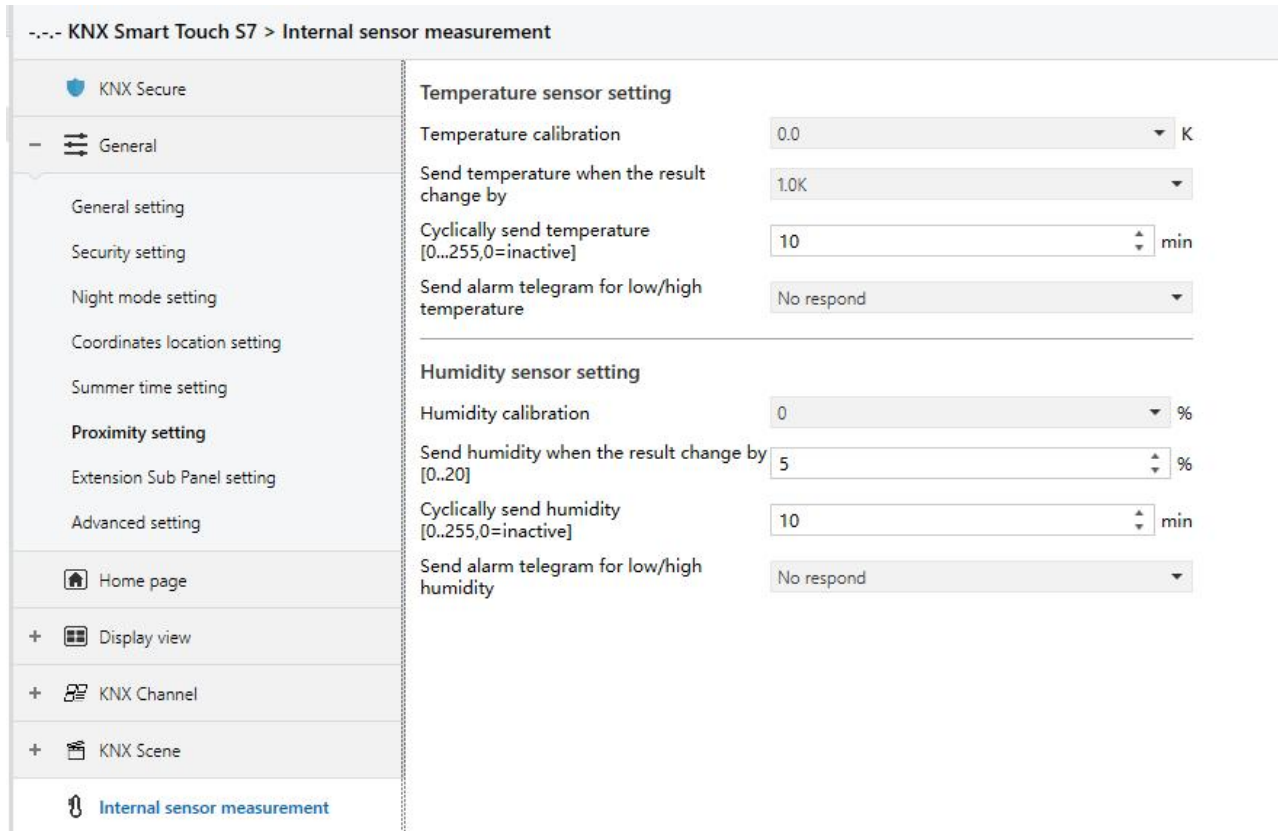

Fig.5.13 "Internal sensor measurement"parameter window

The following parameters is used for setting the calibration value, sending condition and error report of internal sensor. If internal sensor is selected for other functions as well, please refer to this section.

Temperature sensor setting

Parameter "Temperature calibration"

This parameter is for setting the temperature calibration value of the internal sensor, that is, to calibrate the measured value of internal sensor to make it closer to the current ambient temperature.

Options:

-5K

...

0K

...

5K

Note: after the device is powered on, the stability time of internal sensor detection will take 30 minutes, therefore, the detected temperature value in the early stage of device work may be inaccurate.

Parameter "Send temperature when the result change by"

This parameter is for setting when temperature turns to a certain value, whether to enable to send the current temperature value to the bus. Not send when disable. Options:

Disable**0.5K****1.0K**

...

10K**Parameter "Cyclically send temperature [0...255.0=inactive]min"**

Setting the time for cyclically sending the temperature detection value to the bus. Options: **0..255**

This period is independent and starts time counting after programming completion or reset.

Transmission change has no affect on this period.

Parameter "Send alarm telegram for low/high temperature"

This parameter is for setting condition of sending telegram when low/high temperature alarm.

Options:

No respond**Respond after read only****Respond after change**

Respond after read only: Only when the device receives a read alarm from other bus device or bus will the object "Low temperature alarm"/" High temperature alarm" send the alarm status to the bus.

Respond after change: the object " Low temperature alarm"/" High temperature alarm" will immediately send the telegram to the bus to report the alarm value when the alarm status has changed.

These two parameters as follow are visible when "Respond after read only" or "Respond after change" are selected.

—Parameter "**Threshold value for low temperature alarm [0..15]°C**"

This parameter is for setting the threshold value for low temperature alarm. When the temperature lower than low threshold, low temperature alarm object will send telegram. Options:

0°C

1°C

...

15°C

—Parameter "**Threshold value for high temperature alarm [30..45]°C**"

This parameter is for setting the threshold value for high temperature alarm. When the temperature higher than high threshold, high temperature alarm object will send telegram. Options:

30°C

31°C

...

45°C

Humidity sensor setting

Parameter "Humidity calibration"

This parameter is for setting the humidity calibration value of the internal sensor, that is, to calibrate the measured value of internal sensor to make it closer to the current ambient humidity.

Options: **-20% / -15% / -10% / -5% / -3% / -1% / 0% / 1% / 3% / 5% / 10% / 15% / 20%**

Parameter "Send humidity when the result change by [0..20]%"

This parameter is for setting when humidity turns to a certain value, whether to enable to send the current humidity value to the bus. Not send when value is 0. Options: **0..20**

Parameter "Cyclically send humidity [0..255,0=inactive]min"

Setting the time for cyclically sending the humidity detection value to the bus. Options: **0..255**

This period is independent and starts time counting after programming completion or reset.

Transmission change has no affect on this period.

Parameter "Send alarm telegram for low/high humidity"

This parameter is for setting condition of sending telegram when low/high humidity alarm.

Options:

No respond

Respond after read only

Respond after change

Respond after read only: Only when the device receives a read alarm from other bus device or bus will the object " Low humidity alarm"/" High humidity alarm" send the alarm status to the bus;

Respond after change: the object " Low humidity alarm"/" High humidity alarm" will immediately send the telegram to the bus to report the alarm value when the alarm status has changed.

These two parameters as follow are visible when "Respond after read only" or "Respond after change" are selected.

Parameters as follow are visible when "Respond after read only" or "Respond after change" is selected.

—Parameter "Threshold value for low humidity alarm [5..20]%"

This parameter is for setting the threshold value for low humidity alarm. When the humidity lower than low threshold, low humidity alarm object will send telegram. Options: **5..20**

—Parameter "Threshold value for high humidity alarm [70..85]%"

This parameter is for setting the threshold value for high humidity alarm. When the humidity higher than high threshold, high humidity alarm object will send telegram. Options: **70..85**

Chapter 6 Description of Communication Object

The communication object is the medium to communicate other device on the bus, namely only the communication object can communicate with the bus.

NOTE: “C” in “Flag” column in the below table means enable the communication function of the object; “W” means value of object can be written from the bus; “R” means the value of the object can be read by the other devices; “T” means the object has the transmission function; “U” means the value of the object can be updated.

6.1 “General” Communication Object

Number *	Name	Object Function	Description	Group Address	Length	C	R	W	T	U	Data Type	Priority
1	General	In operation			1 bit	C	R	-	T	-	switch	Low
2	General	Date			3 bytes	C	-	W	-	-	date	Low
3	General	Time			3 bytes	C	-	W	-	-	time of day	Low
4	General	Screen brightness			1 byte	C	-	W	-	-	percentage (0..100%)	Low

Fig.6.1 “General”communication object

NO.	Name	Object Function	Data Type	Flag	DPT
1	General	In operation	1bit	C,R,T	1.001 switch
<p>The communication object is used to periodically send a telegram “1” to the bus to indicate that the device is working properly.</p>					
2/3	General	Date/Time	3byte	C,W,T	11.001 date 10.001 time of day
<p>The communication object is used to modify the display date on the screen through the bus.</p> <p>With Cyclic Send enabled, the current time and date can be sent to the bus periodically to facilitate synchronization of the time and date of other devices.</p> <p>Note: When the time is set to auto update on the device, the bus modification is invalid.</p>					
4	General	Screen brightness	1byte	C,W	5.001 percentage(0..100%)
<p>The communication object is used to modify the backlight brightness of the screen.</p> <p>Brightness output range: 10~100%, when the telegram value is less than 10%, directly output 10%</p>					

brightness.

The object is visible when the parameter "Screen brightness can be changed via bus" is enable.

Note: The bus modification is invalid when the screen backlight brightness is set to adjust automatically on the device side.

Table 6.1 "General" communication object

6.2 “Internal sensor” Communication Object

Number ^	Name	Object Function	Description	Group Address	Length	C	R	W	T	U	Data Type	Priority
5	Internal sensor	Temperature value			2 bytes	C	R	-	T	-	temperature (°C)	Low
6	Internal sensor	Low temperature alarm			1 bit	C	R	-	T	-	alarm	Low
7	Internal sensor	High temperature alarm			1 bit	C	R	-	T	-	alarm	Low
8	Internal sensor	Humidity value			2 bytes	C	R	-	T	-	humidity (%)	Low
9	Internal sensor	Low humidity alarm			1 bit	C	R	-	T	-	alarm	Low
10	Internal sensor	High humidity alarm			1 bit	C	R	-	T	-	alarm	Low

Fig.6.2 “Internal sensor”communication object

NO.	Name	Object Function	Data Type	Flag	DPT
5	Internal sensor	Temperature value	2byte	C,R,T	9.001 temperature
<p>The communication object is used for transmitting the temperature value detected by the built-in temperature sensor of the device to the bus. Range:-50~99.8°C</p>					
6	Internal sensor	Low temperature alarm	1bit	C,R,T	1.005 alarm
<p>The communication object is used to send the low temperature alarm signal to bus, when temperature lower than low threshold that defined by parameter.</p>					
7	Internal sensor	High temperature alarm	1bit	C,R,T	1.005 alarm
<p>The communication object is used to send the high temperature alarm signal to bus, when temperature higher than high threshold that defined by parameter.</p>					
10	Internal sensor	Humidity value	2byte	C,R,T	9.007 humidity
<p>The communication object is used to send humidity measurements sent from the humidity sensor on the bus. Range:0~100%</p>					
11	Internal sensor	Low humidity alarm	1bit	C,R,T	1.005 alarm
<p>The communication object is used to send the low humidity alarm signal to bus, when humidity lower than low threshold that defined by parameter.</p>					
12	Internal sensor	High humidity alarm	1bit	C,R,T	1.005 alarm
<p>The communication object is used to send the high humidity alarm signal to bus, when humidity higher than high threshold that defined by parameter.The threshold is defined by the parameter.</p>					

Table 6.2 “Internal sensor”通讯对象

6.3 "Logic" Communication Object

6.3.1 "AND/OR/XOR" Communication Object

Number ^	Name	Object Function	Description	Group Address	Length	C	R	W	T	U	Data Type	Priority
11	1st Logic-...	Input a			1 bit	C	-	W	T	U	boolean	Low
12	1st Logic-...	Input b			1 bit	C	-	W	T	U	boolean	Low
13	1st Logic-...	Input c			1 bit	C	-	W	T	U	boolean	Low
14	1st Logic-...	Input d			1 bit	C	-	W	T	U	boolean	Low
15	1st Logic-...	Input e			1 bit	C	-	W	T	U	boolean	Low
16	1st Logic-...	Input f			1 bit	C	-	W	T	U	boolean	Low
17	1st Logic-...	Input g			1 bit	C	-	W	T	U	boolean	Low
18	1st Logic-...	Input h			1 bit	C	-	W	T	U	boolean	Low
19	1st Logic-...	Logic result			1 bit	C	-	-	T	-	boolean	Low

Fig.6.3.1 "AND/OR/XOR"communication object

NO.	Name	Object Function	Data Type	Flag	DPT
11/.../18	1st Logic- {{...}}	Input X	1 bit	C,W,T,U	1.002 boolean
<p>The name in parentheses changes with the parameter "Description for logic function". If description is empty, display "1st Logic- {{...}}" by default. The same below.</p> <p>The communication object is used to receive the value of logical input Input x.</p>					
19	1st Logic- {{...}}	Logic result	1 bit	C,T	1.002 boolean
<p>The communication object is used to send the results of logical operation.</p>					

Table 6.3.1 "AND/OR/XOR"communication object

6.3.2 “Gate forwarding” Communication Object

Number ^	Name	Object Function	Description	Group Address	Length	C	R	W	T	U	Data Type	Priority
11	1st Logic-...	Gate value select			1 byte	C	-	W	-	-	scene number	Low
12	1st Logic-...	Input A			1 bit	C	-	W	-	-	switch	Low
13	1st Logic-...	Input B			1 bit	C	-	W	-	-	switch	Low
14	1st Logic-...	Input C			1 bit	C	-	W	-	-	switch	Low
15	1st Logic-...	Input D			1 bit	C	-	W	-	-	switch	Low
16	1st Logic-...	Output A			1 bit	C	-	-	T	-	switch	Low
17	1st Logic-...	Output B			1 bit	C	-	-	T	-	switch	Low
18	1st Logic-...	Output C			1 bit	C	-	-	T	-	switch	Low
19	1st Logic-...	Output D			1 bit	C	-	-	T	-	switch	Low

Fig.6.3.2 “Gate forwarding”communication object

NO.	Name	Object Function	Data Type	Flag	DTP
11	1st Logic- {{...}}	Gate value select	1byte	C,W	17.001 scene number
The communication object is used to select the scene of logical gate forwarding.					
12/.../15	1st Logic- {{...}}	Input X	1bit/4bit/1byte	C,W	1.001 switch 3.007 dimming 5.010 counter
The communication object is used to receive the value of the logic gate input Input x.					
16/.../19	1st Logic- {{...}}	Output X	1bit/4bit/1byte	C,T	1.001 switch 3.007 dimming 5.010 counter
The communication object is used to output the value forwarded by the logic gate. The output value is the same as the input value, but one input can be forwarded into one or more outputs, set by parameters.					

Table 6.3.2 “Gate forwarding”communication object

6.3.3 “Threshold comparator” Communication Object

Number ^	Name	Object Function	Description	Group Address	Length	C	R	W	T	U	Data Type	Priority
11	1st Logic-...	Threshold value input			1 byte	C	-	W	-	U	counter pulses (0..255)	Low
19	1st Logic-...	Logic result			1 bit	C	-	-	T	-	boolean	Low

Fig.6.3.3 “Threshold comparator”communication object

NO.	Name	Object Function	Data Type	Flag	DTP
11	1st Logic- {...}	Threshold value input	4bit	C,W,U	3.007 dimming
			1byte		5.010 counter pulses
			2byte		7.001 pulses
			4byte		12.001 counter pulses
					8.x signed value
					9.x float value
					9.001 temperature
					9.007 humidity
					9.004 lux
The communication object is used to input threshold value.					
19	1st Logic- {...}	Logic result	1bit	C,T	1.002 boolean
The communication object is used to send the results of logical operation. That is, the value that should be sent after the object input threshold is compared with the setting threshold value.					

Table 6.3.3 “Threshold comparator”communication object

6.3.4 "Format convert" Communication Object

Number ^	Name	Object Function	Description	Group Address	Length	C	R	W	T	U	Data Type	Priority
11	1st Logic...	Input 1bit-bit0			1 bit	C	-	W	-	U	boolean	Low
12	1st Logic...	Input 1bit-bit1			1 bit	C	-	W	-	U	boolean	Low
19	1st Logic...	Output 2bit			2 bit	C	-	-	T	-	switch control	Low

"2x1bit --> 1x2bit"function: converts two 1bit values to a 2bit value, such as Input bit1=1, bit0=0-->

Output 2bit=2

Number ^	Name	Object Function	Description	Group Address	Length	C	R	W	T	U	Data Type	Priority
11	1st Logic...	Input 1bit-bit0			1 bit	C	-	W	-	U	boolean	Low
12	1st Logic...	Input 1bit-bit1			1 bit	C	-	W	-	U	boolean	Low
13	1st Logic...	Input 1bit-bit2			1 bit	C	-	W	-	U	boolean	Low
14	1st Logic...	Input 1bit-bit3			1 bit	C	-	W	-	U	boolean	Low
15	1st Logic...	Input 1bit-bit4			1 bit	C	-	W	-	U	boolean	Low
16	1st Logic...	Input 1bit-bit5			1 bit	C	-	W	-	U	boolean	Low
17	1st Logic...	Input 1bit-bit6			1 bit	C	-	W	-	U	boolean	Low
18	1st Logic...	Input 1bit-bit7			1 bit	C	-	W	-	U	boolean	Low
19	1st Logic...	Output 1byte			1 byte	C	-	-	T	-	counter pulses (0..255)	Low

"8x1bit --> 1x1byte"function: converts eight 1bit values to a 1byte value, such as Input bit2=1,

bit1=1, bit0=1,other bits are 0--> Output 1byte=7

Number ^	Name	Object Function	Description	Group Address	Length	C	R	W	T	U	Data Type	Priority
11	1st Logic...	Input 1byte			1 byte	C	-	W	-	U	counter pulses (0..255)	Low
19	1st Logic...	Output 2byte			2 bytes	C	-	-	T	-	pulses	Low

"1x1byte --> 1x2byte"function: converts one 1byte values to a 2byte value, such as Input

1byte=125--> Output 2byte=125.Although the value remains the same, the data type of the value is different.

Number ^	Name	Object Function	Description	Group Address	Length	C	R	W	T	U	Data Type	Priority
11	1st Logic...	Input 1byte-low			1 byte	C	-	W	-	U	counter pulses (0..255)	Low
12	1st Logic...	Input 1byte-high			1 byte	C	-	W	-	U	counter pulses (0..255)	Low
19	1st Logic...	Output 2byte			2 bytes	C	-	-	T	-	pulses	Low

"2x1byte --> 1x2byte"function: converts two 1byte values to a 2byte value, such as Input 1byte-low

= 255 (\$FF), Input 1byte-high = 100 (\$64) --> Output 2byte = 25855 (\$64 FF)

Number ^	Name	Object Function	Description	Group Address	Length	C	R	W	T	U	Data Type	Priority
11	1st Logic...	Input 2byte-low			2 bytes	C	-	W	-	U	pulses	Low
12	1st Logic...	Input 2byte-high			2 bytes	C	-	W	-	U	pulses	Low
19	1st Logic...	Output 4byte			4 bytes	C	-	-	T	-	counter pulses (unsign...)	Low

"2x2byte --> 1x4byte"function: converts two 2 byte values to a 4byte value, such as Input 2byte-low

= 65530 (\$FF FA), Input 2byte-high = 32768 (\$80 00)--> Output 2byte = 2147549178 (\$80 00 FF FA)

Number ^	Name	Object Function	Description	Group Address	Length	C	R	W	T	U	Data Type	Priority
11	1st Logic...	Input 1byte			1 byte	C	-	W	-	U	counter pulses (0..255)	Low
12	1st Logic...	Output 1bit-bit0			1 bit	C	-	-	T	-	boolean	Low
13	1st Logic...	Output 1bit-bit1			1 bit	C	-	-	T	-	boolean	Low
14	1st Logic...	Output 1bit-bit2			1 bit	C	-	-	T	-	boolean	Low
15	1st Logic...	Output 1bit-bit3			1 bit	C	-	-	T	-	boolean	Low
16	1st Logic...	Output 1bit-bit4			1 bit	C	-	-	T	-	boolean	Low
17	1st Logic...	Output 1bit-bit5			1 bit	C	-	-	T	-	boolean	Low
18	1st Logic...	Output 1bit-bit6			1 bit	C	-	-	T	-	boolean	Low
19	1st Logic...	Output 1bit-bit7			1 bit	C	-	-	T	-	boolean	Low

“1x1byte -> 8x1bit” function: converts one 1byte values to eight 1bit value, such as Input 1byte=200 -> Output bit0=0, bit1=0, bit2=0, bit3=1, bit4=0, bit5=0, bit6=1, bit7=1

Number ^	Name	Object Function	Description	Group Address	Length	C	R	W	T	U	Data Type	Priority
11	1st Logic...	Input 2byte			2 bytes	C	-	W	-	U	pulses	Low
18	1st Logic...	Output 1byte-low			1 byte	C	-	-	T	-	counter pulses (0..255)	Low
19	1st Logic...	Output 1byte-high			1 byte	C	-	-	T	-	counter pulses (0..255)	Low

“1x2byte -> 2x1byte”function: converts one 2byte values to two 1byte value, such as Input 2byte = 55500 (\$D8 CC) -> Output 1byte-low = 204 (\$CC), Output 1byte-high =216 (\$D8)

Number ^	Name	Object Function	Description	Group Address	Length	C	R	W	T	U	Data Type	Priority
11	1st Logic...	Input 4byte			4 bytes	C	-	W	-	U	counter pulses (unsign...)	Low
18	1st Logic...	Output 2byte-low			2 bytes	C	-	-	T	-	pulses	Low
19	1st Logic...	Output 2byte-high			2 bytes	C	-	-	T	-	pulses	Low

“1x4byte -> 2x2byte”function: converts one 4byte values to two 2byte value, such as Input 4byte = 78009500 (\$04 A6 54 9C) -> Output 2byte-low = 21660 (\$54 9C), Output 2byte-high =1190 (\$04 A6)

Number ^	Name	Object Function	Description	Group Address	Length	C	R	W	T	U	Data Type	Priority
11	1st Logic...	Input 3byte			3 bytes	C	-	W	-	U	RGB value 3x(0..255)	Low
17	1st Logic...	Output 1byte-low			1 byte	C	-	-	T	-	counter pulses (0..255)	Low
18	1st Logic...	Output 1byte-middle			1 byte	C	-	-	T	-	counter pulses (0..255)	Low
19	1st Logic...	Output 1byte-high			1 byte	C	-	-	T	-	counter pulses (0..255)	Low

“1x3byte -> 3x1byte”function: converts one 3byte values to three 1byte value, such as Input 3byte = \$78 64 C8-> Output 1byte-low = 200 (\$C8) , Output 1byte-middle = 100 (\$64) , Output 1byte-high =120 (\$78)

Number ^	Name	Object Function	Description	Group Address	Length	C	R	W	T	U	Data Type	Priority
11	1st Logic...	Input 1byte-low			1 byte	C	-	W	-	U	counter pulses (0..255)	Low
12	1st Logic...	Input 1byte-middle			1 byte	C	-	W	-	U	counter pulses (0..255)	Low
13	1st Logic...	Input 1byte-high			1 byte	C	-	W	-	U	counter pulses (0..255)	Low
19	1st Logic...	Output 3byte			3 bytes	C	-	-	T	-	RGB value 3x(0..255)	Low

“3x1byte -> 1x3byte”function: converts three 1byte values to a 3byte value, such as Input 1byte-low = 150 (\$96), Input 1byte-middle = 100 (\$64), Input 1byte-high = 50 (\$32)--> Output 3byte = \$32 64 96

Fig.6.3.4 “Format convert”communication object

NO.	Name	Object Function	Data Type	Flag	DTP
11	1st Logic- {...}	Input ...	1bit	C,W,U	1.002 boolean
			1byte		5.010 counter pulses
			2byte		7.001 pulses
			3byte		12.001 counter pulses
			4byte		232.600 RGB value 3x(0..255)
The communication object is used to input a value that needs to be converted.					
19	1st Logic- {...}	Output ...	1bit	C,T	1.002 boolean
			2bit		2.001 switch control
			1byte		5.010 counter pulses
			2byte		7.001 pulses
			3byte		12.001 counter pulses
4byte	232.600 RGB value 3x(0..255)				
The communication object is used to output the converted value.					

Table 6.3.4 "Format convert" communication object

6.3.5 “Gate function” Communication Object

Number ^	Name	Object Function	Description	Group Address	Length	C	R	W	T	U	Data Type	Priority
11	1st Logic-...	Input			1 bit	C	-	W	-	-	switch	Low
12	1st Logic-...	Gate input			1 bit	C	-	W	-	-	boolean	Low
19	1st Logic-...	Output			1 bit	C	-	-	T	-	switch	Low

Fig.6.3.5 “Gate function”communication object

NO.	Name	Object Function	Data Type	Flag	DTP
11	1st Logic- {...}	Input	1bit	C,W	1.001 switch
			1byte		5.001 percentage
			2byte		5.010 counter pulses
					9.001 temperature
					7.001 pulses
The communication object is used to input a value that needs to gate filter.					
12	1st Logic- {...}	Gate input	1bit	C,W	1.002 boolean
The communication object is used to control the switch status of gate input. Input signal is allowed to pass when gate open, then output, and the current input status is still sent if there is a change; Can not pass when gate close.					
19	1st Logic- {...}	Output	1bit	C,T	1.001 switch
			1byte		5.001 percentage
			2byte		5.010 counter pulses
					9.001 temperature
					7.001 pulses
The communication object is used to output the value after gate filtering. Only when gate input status is open, output is available, defined by the object “Gate input”.					

Table 6.3.5 “Gate function”communication object

6.3.6 "Delay function" Communication Object

Number ^	Name	Object Function	Description	Group Address	Length	C	R	W	T	U	Data Type	Priority
11	1st Logic-...	Input			1 bit	C	-	W	-	-	switch	Low
19	1st Logic-...	Output			1 bit	C	-	-	T	-	switch	Low

Input/Output - 1bit[On/Off]

Number ^	Name	Object Function	Description	Group Address	Length	C	R	W	T	U	Data Type	Priority
11	1st Logic-...	Input			1 byte	C	-	W	-	-	percentage (0..100%)	Low
19	1st Logic-...	Output			1 byte	C	-	-	T	-	percentage (0..100%)	Low

Input/Output - 1byte[0..100%]

Number ^	Name	Object Function	Description	Group Address	Length	C	R	W	T	U	Data Type	Priority
11	1st Logic-...	Input			1 byte	C	-	W	-	-	counter pulses (0..255)	Low
19	1st Logic-...	Output			1 byte	C	-	-	T	-	counter pulses (0..255)	Low

Input/Output - 1byte[0..255]

Number ^	Name	Object Function	Description	Group Address	Length	C	R	W	T	U	Data Type	Priority
11	1st Logic-...	Input			2 bytes	C	-	W	-	-	temperature (°C)	Low
19	1st Logic-...	Output			2 bytes	C	-	-	T	-	temperature (°C)	Low

Input/Output - 2byte[Float]

Number ^	Name	Object Function	Description	Group Address	Length	C	R	W	T	U	Data Type	Priority
11	1st Logic-...	Input			2 bytes	C	-	W	-	-	pulses	Low
19	1st Logic-...	Output			2 bytes	C	-	-	T	-	pulses	Low

Input/Output - 2byte[0..65535]

Fig.6.3.6 "Delay function" communication object

NO.	Name	Object Function	Data Type	Flag	DTP
11	1st Logic- {{...}}	Input	1bit 1byte 2byte	C,W	1.001 switch 5.001 percentage 5.010 counter pulses 9.001 temperature 7.001 pulses
The communication object is used to input a value that needs to delay.					
19	1st Logic- {{...}}	Output	1bit 1byte 2byte	C,T	1.001 switch 5.001 percentage 5.010 counter pulses 9.001 temperature 7.001 pulses
The communication object is used to output that needs to delay converted value, delay time is defined by the parameter.					

Table 6.3.6 "Delay function"communication object

6.3.7 “Staircase lighting” Communication Object

Number ^	Name	Object Function	Description	Group Address	Length	C	R	W	T	U	Data Type	Priority
11	1st Logic-...	Trigger value			1 bit	C	-	W	-	-	trigger	Low
12	1st Logic-...	Light-on duration time			2 bytes	C	-	W	-	-	time (s)	Low
19	1st Logic-...	Output			1 bit	C	-	-	T	-	switch	Low

Fig.6.3.7 “Staircase lighting”communication object

NO.	Name	Object Function	Data Type	Flag	DTP
11	1st Logic- {{...}}	Trigger value	1bit	C,W	1.017 trigger
The communication object is used to receive the value to trigger staircase lighting.					
12	1st Logic- {{...}}	Light-on duration time	2byte	C,W	7.005 time(s)
The communication object is used to modify the staircase light-on duration time, the modified range is referenced from the range defined by the parameter, take the limit value if exceeded.					
19	1st Logic- {{...}}	Output	1bit/1byte	C,T	1.001 switch 5.010 counter pulses
The communication object is used to output telegram values when triggered. Telegram value is determined by the parameter setting datatype.					

Table 6.3.7 “Staircase lighting”communication object

6.4 "Scene Group setting" Communication Object

Number ^	Name	Object Function	Description	Group Address	Length	C	R	W	T	U	Data Type	Priority
83	Scene Group	Main scene trigger			1 byte	C	-	W	-	-	scene number	Low
84	1st Scene Group-Output 1	1bit value			1 bit	C	-	-	T	-	switch	Low

1 bit value

Number ^	Name	Object Function	Description	Group Address	Length	C	R	W	T	U	Data Type	Priority
83	Scene Group	Main scene trigger			1 byte	C	-	W	-	-	scene number	Low
84	1st Scene Group-Output 1	1byte unsigned value			1 byte	C	-	-	T	-	counter pulses (0..255)	Low

1 byte

Number ^	Name	Object Function	Description	Group Address	Length	C	R	W	T	U	Data Type	Priority
83	Scene Group	Main scene trigger			1 byte	C	-	W	-	-	scene number	Low
84	1st Scene Group-Output 1	HVAC mode			1 byte	C	-	-	T	-	HVAC mode	Low

HVAC mode

Number ^	Name	Object Function	Description	Group Address	Length	C	R	W	T	U	Data Type	Priority
83	Scene Group	Main scene trigger			1 byte	C	-	W	-	-	scene number	Low
84	1st Scene Group-Output 1	2byte unsigned value			2 bytes	C	-	-	T	-	pulses	Low

2byte unsigned value

Number ^	Name	Object Function	Description	Group Address	Length	C	R	W	T	U	Data Type	Priority
83	Scene Group	Main scene trigger			1 byte	C	-	W	-	-	scene number	Low
84	1st Scene Group-Output 1	Temperature			2 bytes	C	-	-	T	-	temperature (°C)	Low

Temperature

Number ^	Name	Object Function	Description	Group Address	Length	C	R	W	T	U	Data Type	Priority
83	Scene Group	Main scene trigger			1 byte	C	-	W	-	-	scene number	Low
84	1st Scene Group-Output 1	RGB value			3 bytes	C	-	-	T	-	RGB value 3x(0..255)	Low

RGB value

Number ^	Name	Object Function	Description	Group Address	Length	C	R	W	T	U	Data Type	Priority
83	Scene Group	Main scene trigger			1 byte	C	-	W	-	-	scene number	Low
84	1st Scene Group-Output 1	RGBW value			6 bytes	C	-	-	T	-	RGBW value 4x(0..100%)	Low

RGBW value

Fig.6.4 "Scene Group setting"communication object

NO.	Name	Object Function	Data Type	Flag	DPT
83	Scene Group	Main scene trigger	1byte	C,W	17.001 scene number
This communication object triggers each output in the scene group to send a specific value to the bus by recalling the scene number. Telegrams: 0.. 63					
84	1st Scene Group-{{Output X}}	1bit value 1byte unsigned value HVAC mode 2byte unsigned value Temperature RGB value RGBW value	1bit 1byte 2byte 3byte 6byte	C,T	1.001 switch 5.010 counter pulses 20.102 HVAC mode 7.001 pulses 9.001 temperature 232.600 RGB value 3x(0..255) 251.600 DPT_Colour_RGBW
When a scene is recalled, the communication object is used to send the corresponding output value of the scene to the bus. If the output is not set to this scene, it will not be sent. A total of 8 scene groups can be set up, with 8 outputs per group.					

Table 6.4 "Scene Group setting"communication object

6.5 "HVAC controller" Communication Object

6.5.1 "Room temperature controller (RTC) " Communication Object

Number *	Name	Object Function	Description	Group Address	Length	C	R	W	T	U	Data Type	Priority
148	Controller 1 - ...	Power on/off			1 bit	C	R	W	-	-	switch	Low
149	Controller 1 - ...	External temperature sensor			2 bytes	C	-	W	T	U	temperature (°C)	Low
150	Controller 1 - ...	Base setpoint adjustment			2 bytes	C	-	W	-	-	temperature (°C)	Low
151	Controller 1 - ...	Setpoint offset			1 bit	C	-	W	-	-	step	Low
152	Controller 1 - ...	Float offset value			2 bytes	C	-	W	-	-	temperature differenc...	Low
153	Controller 1 - ...	Setpoint offset reset			1 bit	C	-	W	-	-	reset	Low
154	Controller 1 - ...	Heating/Cooling mode			1 bit	C	-	W	-	-	cooling/heating	Low
155	Controller 1 - ...	Operation mode			1 byte	C	-	W	-	-	HVAC mode	Low
156	Controller 1 - ...	Comfort mode			1 bit	C	-	W	-	-	enable	Low
157	Controller 1 - ...	Economy mode			1 bit	C	-	W	-	-	enable	Low
158	Controller 1 - ...	Frost/Heat protection mode			1 bit	C	-	W	-	-	enable	Low
159	Controller 1 - ...	Standby mode			1 bit	C	-	W	-	-	enable	Low
160	Controller 1 - ...	Extended comfort mode			1 bit	C	-	W	-	-	acknowledge	Low
161	Controller 1 - ...	Fan automatic operation			1 bit	C	-	W	-	-	enable	Low
162	Controller 1 - ...	Window contact			1 bit	C	-	W	T	U	window/door	Low
163	Controller 1 - ...	Presence detector			1 bit	C	-	W	T	U	occupancy	Low
164	Controller 1 - ...	Actual temperature, status			2 bytes	C	R	-	T	-	temperature (°C)	Low
165	Controller 1 - ...	Base temperature setpoint, status			2 bytes	C	R	-	T	-	temperature (°C)	Low
166	Controller 1 - ...	Setpoint offset, status			2 bytes	C	R	-	T	-	temperature differenc...	Low
167	Controller 1 - ...	Current temperature setpoint, status			2 bytes	C	R	-	T	-	temperature (°C)	Low
168	Controller 1 - ...	Heating/Cooling mode, status			1 bit	C	R	-	T	-	cooling/heating	Low
169	Controller 1 - ...	Operation mode, status			1 byte	C	R	-	T	-	HVAC mode	Low
170	Controller 1 - ...	Comfort mode, status			1 bit	C	R	-	T	-	enable	Low
171	Controller 1 - ...	Economy mode, status			1 bit	C	R	-	T	-	enable	Low
172	Controller 1 - ...	Frost/Heat protection mode, status			1 bit	C	R	-	T	-	enable	Low
173	Controller 1 - ...	Standby mode, status			1 bit	C	R	-	T	-	enable	Low
174	Controller 1 - ...	Heating control value			1 byte	C	R	-	T	-	percentage (0..100%)	Low
175	Controller 1 - ...	Cooling control value			1 byte	C	R	-	T	-	percentage (0..100%)	Low
176	Controller 1 - ...	Fan speed			1 byte	C	-	-	T	-	percentage (0..100%)	Low
177	Controller 1 - ...	Fan speed low			1 bit	C	-	-	T	-	switch	Low
178	Controller 1 - ...	Fan speed medium			1 bit	C	-	-	T	-	switch	Low
179	Controller 1 - ...	Fan speed high			1 bit	C	-	-	T	-	switch	Low
180	Controller 1 - ...	Fan speed off			1 bit	C	-	-	T	-	switch	Low
181	Controller 1 - ...	Additional Heating control value			1 bit	C	R	-	T	-	switch	低
181	Controller 1 - ...	Additional Heating/Cooling control value			1 bit	C	R	-	T	-	switch	低
182	Controller 1 - ...	Additional Cooling control value			1 bit	C	R	-	T	-	switch	低

Fig.6.5.1 "Room temperature controller(RTC)"communication object

NO.	Name	Object Function	Data	Flag	DPT
-----	------	-----------------	------	------	-----

			Type		
148	Controller X-{{...}}	Power on/off	1bit	C,W,R	1.001 switch
<p>The communication object is used to receive the telegram from the bus to control RTC power on/off. Telegrams:</p> <p style="text-align: center;">1—On</p> <p style="text-align: center;">0—Off</p> <p>The name in parentheses changes with the parameter “Description (max 30 char.)”. If description is empty, display “Controller 1 - ...” by default. The same below.</p>					
149	Controller X-{{...}}	External temperature sensor	2byte	C,W,T,U	9.001 temperature
<p>The communication object is used to receive the temperature value detected by the temperature sensor of the device form the bus. Range:-50~99.8°C</p>					
150	Controller X-{{...}}	Current setpoint adjustment Base setpoint adjustment	2byte	C,W	9.001 temperature
<p>“Current setpoint adjustment” is visible when operation mode is not enabled, and under absolute adjustment. Used to modify the base value of the set temperature; and to modify set temperature value of current room operation mode when absolute adjustment.</p> <p>“Base setpoint adjustment” is visible only when relative adjustment, used to modify the base value of the set temperature, that is, the temperature setting value of the comfort mode, and the setting temperature of the standby mode and the economy mode changes according to the relative change. In any case, the temperature setting value of the protection mode cannot be modified by the bus.</p>					
151	Controller X-{{...}}	Setpoint offset	1bit	C,W	1.007 step
<p>The communication object is visible only when absolute adjustment, and offset function enabled. Used to adjust the offset to adjust setpoint temperature indirectly. The step value set according to the parameter. Telegrams:</p> <p style="text-align: center;">1 —Increase the offset in the forward direction</p>					

0 —Decrease the offset in the negative direction					
152	Controller X-{{...}}	Float offset value	2byte	C,W	9.002 temperature difference
The communication object is visible only when absolute adjustment, and offset function enabled. Used to modify the accumulated offset via 2 byte float value.					
153	Controller X-{{...}}	Setpoint offset reset	1bit	C,W	1.015 reset
The communication object is visible only when absolute adjustment, and offset function enabled. Reset offset value when telegram is 1.					
154	Controller X-{{...}}	Heating/Cooling mode	1bit	C,W	1.100 cooling/heating
The communication object is used for switching the heating and cooling via the bus. Telegrams: 1 —Heating 0 —Cooling					
155	Controller X-{{...}}	Operation mode	1byte	C,W	20.102 HVAC mode
156	Controller X-{{...}}	Comfort mode	1bit	C,W	1.003 enable
157	Controller X-{{...}}	Economy mode	1bit	C,W	1.003 enable
158	Controller X-{{...}}	Frost/Heat protection mode	1bit	C,W	1.003 enable
159	Controller X-{{...}}	Standby mode	1bit	C,W	1.003 enable
These communication objects are used to control the RTC operation mode via the bus. When 1 byte: object 155 is visible, telegrams: 1-comfort, 2-standby, 3-economy, 4-protection, other reserved. When 1bit: Object 156— Comfort mode Object 157— Standby mode					

Object 158— Economy mode

Object 159— Protection mode

When the object receives the telegram “1”, the corresponding mode is activated. When 1 bit standby object is not enable, and the telegrams of comfort, economy, protection mode are 0, is standby mode. When 1 bit standby object is enable, standby object receives “1” activates standby mode, 0 is no processing.

160	Controller X-{{...}}	Extended comfort mode	1bit	C,W	1.016 acknowledge
------------	-----------------------------	------------------------------	-------------	------------	--------------------------

The communication object is used for triggering time to extended comfort mode. Telegrams:

1—Activate comfort mode

0—No sense

Activate comfort mode when the object receives telegram 1. If receive again telegram 1 in delay time, time will be timed again. And return the previous operation mode from comfort mode once finish timing. If there is a new operation mode in delay time, exit the comfort mode.

If a switch operation, exit the timing, but switch the heating/cooling will not.

161	Controller X-{{...}}	Fan automatic operation	1bit	C,W	1.003 enable
------------	-----------------------------	--------------------------------	-------------	------------	---------------------

The communication object is used to activate the fan automatic operation via the bus. Telegram:

1—Activate auto

0—Exit auto

162	Controller X-{{...}}	Window contact	1bit	C,W,T,U	1.019 Window/door
------------	-----------------------------	-----------------------	-------------	----------------	--------------------------

The communication object is used to receive the switch status of window contact. Telegrams:

1—The window is open

0—The window is close

163	Controller X-{{...}}	Presence detector	1bit	C,W,T,U	1.018 occupancy
------------	-----------------------------	--------------------------	-------------	----------------	------------------------

The communication object is used to receive the room occupancy status from presence detector.

Telegrams:

1—Occupied

0—Unoccupied

164	Controller X-{{...}}	Actual temperature, status	2byte	C,R,T	9.001 temperature
The communication object is visible when temperature reference of RTC function is combination of internal and external sensor. Used to send the actual temperature after the combination to the bus.					
165	Controller X-{{...}}	Base temperature setpoint, status	2byte	C,R,T	9.001 temperature
The communication object is visible only when relative adjustment. Used to send the current base set temperature to the bus.					
166	Controller X-{{...}}	Setpoint offset, status	2byte	C,R,T	9.002 temperature difference
The communication object is visible only when relative adjustment. Used to send the accumulated offset value of base set temperature to the bus.					
167	Controller X-{{...}}	Current temperature setpoint, status	2byte	C,R,T	9.001 temperature
The communication object is used to send current set temperature to the bus.					
168	Controller X-{{...}}	Heating/Cooling mode, status	1bit	C,R,T	1.100 cooling/heating
The communication object is used to feedback the telegram of switching cooling and heating function to the bus.					
169	Controller X-{{...}}	Operation mode, status	1byte	C,R,T	20.102 HVAC mode
170	Controller X-{{...}}	Comfort mode, status	1bit	C,R,T	1.003 enable
171	Controller X-{{...}}	Economy mode, status	1bit	C,R,T	1.003 enable

172	Controller X-{{...}}	Frost/Heat protection mode, status	1bit	C,R,T	1.003 enable
173	Controller X-{{...}}	Standby mode, status	1bit	C,R,T	1.003 enable
<p>These communication objects are used to send RTC operation mode status to the bus.</p> <p>When 1 byte: object 169 is visible, telegrams: 1-comfort, 2-standby, 3-economy, 4-protection, other reserved.</p> <p>When 1bit:</p> <p style="padding-left: 40px;">Object 170— Comfort mode</p> <p style="padding-left: 40px;">Object 171— Economy mode</p> <p style="padding-left: 40px;">Object 172— Protection mode</p> <p style="padding-left: 40px;">Object 173— Standby mode</p> <p>When a mode is activated, the corresponding object only sends telegram “1”. When 1 bit standby object is not enable, activate standby mode when comfort, economy, protection objects send telegram 0 together. When 1 bit standby object is enable, activate standby mode only when standby object send 1.</p> <p>Note: no requirement to send mode status to the bus when switchover via bus. The same is fan speed and other operation.</p>					
174	Controller X-{{...}}	Heating control value Heating/Cooling control value	1bit/1byte	C,R,T	1.001 switch/5.001 percentage
175	Controller X-{{...}}	Cooling control value	1bit/1byte	C,R,T	1.001 switch/5.001 percentage
<p>The communication object is used to send control value of heating or cooling function to the bus. Object datatype is according to parameter setting.</p>					
176	Controller X-{{...}}	Fan speed	1byte	C,T	5.001 percentage 5.100 fan stage

177	Controller X-{{...}}	Fan speed low	1bit	C,T	1.001 switch
178	Controller X-{{...}}	Fan speed medium	1bit	C,T	1.001 switch
179	Controller X-{{...}}	Fan speed high	1bit	C,T	1.001 switch
180	Controller X-{{...}}	Fan speed off	1bit	C,T	1.001 switch

These communication objects are used to send control telegrams of the fan speed to the bus.

1bit object is visible according to the parameter setting :

Object 177—Low fan speed

Object 178—Medium fan speed

Object 179—High fan speed

Object 180—Fan speed off

Only the corresponding object sends telegram “1” when switch to a certain fan speed. When 1bit-off object is not enable, all objects send telegrams “0” when switch to fan speed off (The situation apply to connect with fan actuator of GVS);

When 1bit-off object is enable, only 1bit-off object send telegram “1” (The situation apply to connect with fan actuator of other manufacturers).

181	Controller X-{{...}}	Additional heating control value Additional heating/cooling control value	1bit/1byte	C,R,T	1.001 switch/5.001 percentage
182	Controller X-{{...}}	Additional cooling control value	1bit/1byte	C,R,T	1.001 switch/5.001 percentage

These communication object is used to send control value of additional heating or cooling function to the bus.

1bit: telegrams: 1-switch on the valves,0-switch off the valve

1byte: telegrams: 100%-switch on the valves, 0%-switch off the valve

Table 6.5.1 “Room temperature controller(RTC)”communication object

6.5.2 “Ventilation controller” Communication Object

Number ^	Name	Object Function	Description	Group Address	Length	C	R	W	T	U	Data Type	Priority
148	Controller 1 - ...	Fan automatic operation			1 bit	C	R	W	-	-	enable	Low
149	Controller 1 - ...	PM 2.5 value			2 bytes	C	-	W	T	U	pulses	Low
176	Controller 1 - ...	Fan speed			1 byte	C	-	-	T	-	percentage (0..100%)	Low

Fig.6.5.2 “Ventilation controller”communication object

NO.	Name	Object Function	Data Type	Flag	DPT
148	Controller X-{{...}}	Fan automatic operation	1bit	C,R,W	1.003 enable
<p>The communication object is used to activate the fan automatic operation via the bus. Telegram:</p> <p style="text-align: center;">1—Activate auto</p> <p style="text-align: center;">0—Exit auto</p>					
149	Controller X-{{...}}	PM 2.5 value VOC value CO2 value	2byte	C,W,T,U	7.001 pulse 9.030 concentration(ug/m3) 9.008 parts/million(ppm)
<p>The communication object is used to receive the input of the PM2.5/VOC/CO2 value. The data type of object is set by the parameter.Range:0~999ug/m³ or 0~4000ppm.</p>					
176	Controller X-{{...}}	Fan speed	1byte	C,T	5.001 percentage 5.100 fan stage
<p>The communication object is used to send the fan speed under auto control to the bus. Corresponding telegrams of each fan speed are determined by parameter setting.</p>					

Table 6.5.2 “Ventilation controller”communication object

6.6 "Human Centric Lighting(HCL)" Communication Object

Number ^	Name	Object Function	Description	Group Address	Length	C	R	W	T	U	Data Type	Priority
358	Human Centric Lighting(...)	Start HCL			1 bit	C	-	W	-	-	start/stop	Low
359	Human Centric Lighting(...)	HCL status			1 bit	C	R	-	T	-	state	Low
360	Human Centric Lighting(...)	Brightness value			1 byte	C	-	-	T	-	percentage (0..100%)	Low
361	Human Centric Lighting(...)	Colour temperature value			2 bytes	C	-	-	T	-	absolute colour tempe...	Low
364	Human Centric Lighting(...)	Switch control			1 bit	C	-	W	-	-	switch	Low
365	Human Centric Lighting(...)	Brightness control value			1 byte	C	-	W	-	-	percentage (0..100%)	Low
366	Human Centric Lighting(...)	Colour temperature control value			2 bytes	C	-	W	-	-	absolute colour tempe...	Low

Normal

362	Human Centric Lighting(HCL)	Warm white brightness			1 byte	C	-	-	T	-	percentage (0..100%)	低
363	Human Centric Lighting(HCL)	Cool white brightness			1 byte	C	-	-	T	-	percentage (0..100%)	低
364	Human Centric Lighting(HCL)	Switch control			1 bit	C	-	W	-	-	switch	低
367	Human Centric Lighting(HCL)	Warm white brightness control value			1 byte	C	-	W	-	-	percentage (0..100%)	低
368	Human Centric Lighting(HCL)	Cool white brightness control value			1 byte	C	-	W	-	-	percentage (0..100%)	低

Directly(with warm/cool white algorithm)

Fig.6.6 "Human Centric Lighting(HCL)"communication object

NO.	Name	Object Function	Data Type	Flag	DPT
358	Human Centric Lighting(HCL)	Start HCL	1bit	C,W	1.010 start/stop
The communication object is used to start the setting of HCL. Telegrams: 1---Start 0---Stop					
359	Human Centric Lighting(HCL)	HCL status	1bit	C,R,T	1.011 state
The communication object is used to send the status telegram of HCL to bus.					
360	Human Centric Lighting(HCL)	Brightness value	1byte	C,T	5.001 percentage(0..100%)
365	Human Centric Lighting(HCL)	Brightness control value	1byte	C,W	5.001 percentage(0..100%)

These two parameters are visible when control brightness via HCL. Telegrams: 0...100%

Obj.360: used for sending dimming telegrams to the bus, that is, sending the brightness value.

Obj.365: used for receiving brightness status responded from bus.

361	Human Centric Lighting(HCL)	Colour temperature value	2byte	C,T	7.600 absolute colour temperature
366	Human Centric Lighting(HCL)	Colour temperature control value	2byte	C,W	7.600 absolute colour temperature

These two communication objects apply to normal control of colour temperature adjustment.

Telegramms: 2000...7000 K

Obj.361: used for sending the control telegram of the colour temperature to the bus.

Obj.366: used for receiving the control telegram of the colour temperature from bus.

362	Human Centric Lighting(HCL)	Warm white brightness	1byte	C,T	5.001 percentage(0..100%)
367	Human Centric Lighting(HCL)	Warm white brightness control value	1byte	C,W	5.001 percentage(0..100%)

These two communication objects apply to the warm white brightness in directly control.

Telegramms: 0...100%

Obj.362: used for sending the warm white dimming telegram to the bus, that is, sending the warm white brightness value.

Obj.367: used for receiving the warm white brightness status responded from bus.

363	Human Centric Lighting(HCL)	Cool white brightness	1byte	C,T	5.001 percentage(0..100%)
368	Human Centric Lighting(HCL)	Cool white brightness control value	1byte	C,W	5.001 percentage(0..100%)

These two communication objects apply to the cool white brightness in directly control.

Telegramms: 0...100%

Obj.363: used for sending the cool white dimming telegram to the bus, that is, sending the cool brightness value.

Obj.368: used for receiving the cool white brightness status responded from bus.

364	Human Centric Lighting(HCL)	Switch control	1bit	C,W	1.001 switch
------------	------------------------------------	-----------------------	-------------	------------	---------------------

During HCL running, stop running HCL when receive the telegram of switch control OFF from bus, the communication object is to receive the telegram of switch control. That is telegram 0 is stop, 1 is meaningless.

Table 6.6 "Human Centric Lighting(HCL)"communication object

6.7 “Schedule function” Communication Object

Number ^	Name	Object Function	Description	Group Address	Length	C	R	W	T	U	Data Type	Priority
369	Schedule 1-...	On/Off			1 bit	C	-	-	T	-	switch	Low
370	Schedule 1-...	Disable/Enable			1 bit	C	-	W	-	-	enable	Low

Number ^	Name	Object Function	Description	Group Address	Length	C	R	W	T	U	Data Type	Priority
369	Schedule 1-...	1byte unsigned value			1 byte	C	-	-	T	-	counter pulses (0..255)	Low

Number ^	Name	Object Function	Description	Group Address	Length	C	R	W	T	U	Data Type	Priority
369	Schedule 1-...	HVAC mode			1 byte	C	-	-	T	-	HVAC mode	Low

Number ^	Name	Object Function	Description	Group Address	Length	C	R	W	T	U	Data Type	Priority
369	Schedule 1-...	Scene control			1 byte	C	-	-	T	-	scene number	Low

Number ^	Name	Object Function	Description	Group Address	Length	C	R	W	T	U	Data Type	Priority
369	Schedule 1-...	2byte unsigned value			2 bytes	C	-	-	T	-	pulses	Low

Number ^	Name	Object Function	Description	Group Address	Length	C	R	W	T	U	Data Type	Priority
369	Schedule 1-...	Temperature value			2 bytes	C	-	-	T	-	temperature (°C)	Low

Fig.6.7 “Schedule function”communication object

NO.	Name	Object Function	Data Type	Flag	DPT
369	Schedule X-{{...}}	On/Off	1bit	C,T	1.001 switch
		1byte unsigned value	1byte		5.010 counter pulses(0..255)
		HVAC mode	1byte		20.102 HVAC mode
		Scene control	1byte		17.001 scene number
		2byte unsigned value	2byte		7.001 pulses
		Temperature value	2byte		9.001 temperature
<p>The communication object is used to send the preset telegram value of the time function to the bus, and the schedule function, default value and object type are set by the parameters. When the time is up, send the default telegram value to the bus. A total of 16 timing(x= 16) can be set .</p>					
370	Schedule X-{{...}}	Disable/Enable	1bit	C,W	1.003 enable
<p>The communication object is used to disable/enable schedule function x. The disable/enable telegram value is specifically defined by the parameter. When disable, schedule x function will be disable.</p>					

Table 6.7 “Schedule function”communication object

6.8 “Alarm function” Communication Object

Number ^	Name	Object Function	Description	Group Address	Length	C	R	W	T	U	Data Type	Priority
401	Alarm 1-...	Alarm acknowledge			1 bit	C	-	-	T	-	acknowledge	Low
402	Alarm 1-...	Alarm message			14 bytes	C	-	W	-	-	Character String (ISO 8...	Low
403	Alarm 1-...	Alarm input			1 bit	C	-	W	T	U	alarm	Low

Fig.6.8 “Alarm function”communication object

NO.	Name	Object Function	Data Type	Flag	DPT
401	Alarm X-{{...}}	Alarm acknowledge	1bit	C,T	1.016 acknowledge
<p>When the user clicks on the screen to acknowledge the warning message, the communication object sends an acknowledge telegram to the bus, and the telegram value is 1.</p>					
402	Alarm X-{{...}}	Alarm message	14byte	C,W	16.001 character string (ISO 8859-1)
<p>The communication object is used to receive the warning message displayed on the screen from bus. When no value is received initially, the warning pop-up is displayed empty.</p>					
403	Alarm X-{{...}}	Alarm input	1bit	C,W,T,U	1.005 alarm
<p>The communication object is used to receive the alarm signal from bus. Telegrams:</p> <p style="margin-left: 40px;">0 — No alarm</p> <p style="margin-left: 40px;">1 — Alarm</p>					

Table 6.8 “Alarm function”communication object

6.9 “KNX Channel general” Communication Object

Number ^	Name	Object Function	Description	Group Address	Length	C	R	W	T	U	Data Type	Priority
473	KNX Channel general	Device online common 1, status			1 bit	C	-	W	T	U	switch	Low

Fig.6.9 “KNX Channel general”communication object

NO.	Name	Object Function	Data Type	Flag	DPT
473...482	KNX Channel general	Device online common X, status	1bit	C,W,T,U	1.* 1-bit

The communication object is displayed when the parameter "Time period request for common x" is greater than 0.

The communication object is used to periodically send a read request telegram for the online status of a generic device in order to query the current online status of each generic device.

Table 6.9 “KNX Channel general”communication object

6.10 “KNX Channel X” Communication Object

Number	Name	Object Function	Description	Group Address	Length	C	R	W	T	U	Data Type	Priority
483	KNX Channel 1-...	Device online, status			1 bit	C	-	W	T	U	switch	Low
484	KNX Channel 1-...	Locking object			1 bit	C	-	W	-	-	enable	Low

Fig.6.10 “KNX Channel X”communication object

NO.	Name	Object Function	Data Type	Flag	DPT
483	KNX Channel X-{{...}}	Device online, status	1bit	C,W,T,U	1.001 switch
<p>This communication object is visible when the device online status reference by “individual”.</p> <p>The communication object is used to periodically send a read request telegram for the online status of a generic device in order to query the current online status of each generic device.</p>					
484	KNX Channel X-{{...}}	Locking object	1bit	C,W	1.003 enable
<p>Suitable for all of the following functions, except sensors, energy metering devices.</p> <p>The communication object is used to lock/unlock the icon function.</p> <p>1-unlock</p> <p>0-lock</p>					

Table 6.10 “KNX Channel X”communication object

6.10.1 "Switch" Communication Object

485	KNX Channel 1-...	Switch	1 bit	C - - T -	switch	低
490	KNX Channel 1-...	Switch, status	1 bit	C - W T U	switch	低

Switch

485	KNX Channel 1-...	Switch	1 bit	C - - T -	switch	低
-----	-------------------	--------	-------	-----------	--------	---

Press/Release switch

Fig.6.10.1"Switch"communication object

NO.	Name	Object Function	Data Type	Flag	DPT
485	KNX Channel X-{{...}}	Switch	1bit	C,T	1.001 switch
<p>This communication object apply to switch, press/release switch, relative/brightness dimming, colour and colour temperature control. Telegrams:</p> <p>1——Turn on the light</p> <p>0——Turn off the light</p>					
490	KNX Channel X-{{...}}	Switch, status	1bit	C,W,T,U	1.001 switch 3.007 dimming
<p>The communication object is used to receive the on / off status from other bus devices, and feedback to screen display, applies to switch, relative/brightness dimming, brightness+ colour temperature control and switch indicator.</p>					

Table 6.10.1"Switch"communication object

6.10.2 "Relative/Brightness/Relative&Brightnes dimming" Communication Object

485	KNX Channel 1-...	Switch	1 bit	C - - T -	switch	低
486	KNX Channel 1-...	Relative dimming	4 bit	C - W T -	dimming control	低
490	KNX Channel 1-...	Switch, status	1 bit	C - W T U	switch	低

Relative dimming

485	KNX Channel 1-...	Switch	1 bit	C - - T -	switch	低
487	KNX Channel 1-...	Brightness dimming	1 byte	C - - T -	percentage (0..100%)	低
490	KNX Channel 1-...	Switch, status	1 bit	C - W T U	switch	低
491	KNX Channel 1-...	Brightness, status	1 byte	C - W T U	percentage (0..100%)	低

Brightness dimming

485	KNX Channel 1-...	Switch	1 bit	C - - T -	switch	低
486	KNX Channel 1-...	Relative dimming	4 bit	C - - T -	dimming control	低
487	KNX Channel 1-...	Brightness dimming	1 byte	C - - T -	percentage (0..100%)	低
490	KNX Channel 1-...	Switch, status	1 bit	C - W T U	switch	低
491	KNX Channel 1-...	Brightness, status	1 byte	C - W T U	percentage (0..100%)	低

Relative&Brightness dimming

Fig.6.10.2 "Relative/Brightness/Relative&Brightnes dimming"communication object

NO.	Name	Object Function	Data Type	Flag	DPT
486	KNX Channel X-{{...}}	Relative dimming	4bit	C,W,T	3.007 dimming control
<p>The communication object applies to relative dimming, is used for sending the relative dimming telegram to the bus, such as brighter, darker, or stop-dimming telegram.</p>					
487	KNX Channel X-{{...}}	Brightness dimming	1byte	C,T	5.001 percentage(0..100%)
491	KNX Channel X-{{...}}	Brightness, status	1byte	C,W,T,U	5.001 percentage(0..100%)
<p>These two communication objects apply to brightness dimming. Telegrams: 0~100%</p> <p>Obj.487: used for sending dimming telegrams to the bus, that is, sending the brightness value.</p> <p>Obj.491: used for receiving brightness status responded from dimming actuator.</p>					

Table 6.10.2 "Relative/Brightness/Relative&Brightnes dimming"Communication Object

6.10.3 "RGB/Colour and colour temperature control" Communication Object

Number ^	Name	Object Function	Description	Group Address	Length	C	R	W	T	U	Data Type	Priority
483	KNX Channel 1-...	Device online, status			1 bit	C	-	W	T	U	switch	Low
484	KNX Channel 1-...	Locking object			1 bit	C	-	W	-	-	enable	Low
485	KNX Channel 1-...	Switch			1 bit	C	-	-	T	-	switch	Low
486	KNX Channel 1-...	Red dimming value			1 byte	C	-	-	T	-	percentage (0..100%)	Low
487	KNX Channel 1-...	Green dimming value			1 byte	C	-	-	T	-	percentage (0..100%)	Low
488	KNX Channel 1-...	Blue dimming value			1 byte	C	-	-	T	-	percentage (0..100%)	Low
490	KNX Channel 1-...	Switch, status			1 bit	C	-	W	T	U	switch	Low
491	KNX Channel 1-...	Red brightness, status			1 byte	C	-	W	T	U	percentage (0..100%)	Low
492	KNX Channel 1-...	Green brightness, status			1 byte	C	-	W	T	U	percentage (0..100%)	Low
493	KNX Channel 1-...	Blue brightness, status			1 byte	C	-	W	T	U	percentage (0..100%)	Low

RGB_3x1byte

Number ^	Name	Object Function	Description	Group Address	Length	C	R	W	T	U	Data Type	Priority
483	KNX Channel 1-...	Device online, status			1 bit	C	-	W	T	U	switch	Low
484	KNX Channel 1-...	Locking object			1 bit	C	-	W	-	-	enable	Low
485	KNX Channel 1-...	Switch			1 bit	C	-	-	T	-	switch	Low
486	KNX Channel 1-...	RGB dimming value			3 bytes	C	-	-	T	-	RGB value 3x(0..255)	Low
490	KNX Channel 1-...	Switch, status			1 bit	C	-	W	T	U	switch	Low
491	KNX Channel 1-...	RGB brightness, status			3 bytes	C	-	W	T	U	RGB value 3x(0..255)	Low

RGB_1x3byte

Number ^	Name	Object Function	Description	Group Address	Length	C	R	W	T	U	Data Type	Priority
483	KNX Channel 1-...	Device online, status			1 bit	C	-	W	T	U	switch	Low
484	KNX Channel 1-...	Locking object			1 bit	C	-	W	-	-	enable	Low
485	KNX Channel 1-...	Switch			1 bit	C	-	-	T	-	switch	Low
486	KNX Channel 1-...	Red dimming value			1 byte	C	-	-	T	-	percentage (0..100%)	Low
487	KNX Channel 1-...	Green dimming value			1 byte	C	-	-	T	-	percentage (0..100%)	Low
488	KNX Channel 1-...	Blue dimming value			1 byte	C	-	-	T	-	percentage (0..100%)	Low
489	KNX Channel 1-...	White dimming value			1 byte	C	-	-	T	-	percentage (0..100%)	Low
490	KNX Channel 1-...	Switch, status			1 bit	C	-	W	T	U	switch	Low
491	KNX Channel 1-...	Red brightness, status			1 byte	C	-	W	T	U	percentage (0..100%)	Low
492	KNX Channel 1-...	Green brightness, status			1 byte	C	-	W	T	U	percentage (0..100%)	Low
493	KNX Channel 1-...	Blue brightness, status			1 byte	C	-	W	T	U	percentage (0..100%)	Low
494	KNX Channel 1-...	White brightness, status			1 byte	C	-	W	T	U	percentage (0..100%)	Low

RGBW_4x1byte

Number ^	Name	Object Function	Description	Group Address	Length	C	R	W	T	U	Data Type	Priority
483	KNX Channel 1-...	Device online, status			1 bit	C	-	W	T	U	switch	Low
484	KNX Channel 1-...	Locking object			1 bit	C	-	W	-	-	enable	Low
485	KNX Channel 1-...	Switch			1 bit	C	-	-	T	-	switch	Low
486	KNX Channel 1-...	RGBW dimming value			6 bytes	C	-	-	T	-	RGBW value 4x(0..100%)	Low
490	KNX Channel 1-...	Switch, status			1 bit	C	-	W	T	U	switch	Low
491	KNX Channel 1-...	RGBW brightness, status			6 bytes	C	-	W	T	U	RGBW value 4x(0..100%)	Low

RGBW_1x6byte

Number ^	Name	Object Function	Description	Group Address	Length	C	R	W	T	U	Data Type	Priority
483	KNX Channel 1-...	Device online, status			1 bit	C	-	W	T	U	switch	Low
484	KNX Channel 1-...	Locking object			1 bit	C	-	W	-	-	enable	Low
485	KNX Channel 1-...	Switch			1 bit	C	-	-	T	-	switch	Low
486	KNX Channel 1-...	Red dimming value			1 byte	C	-	-	T	-	percentage (0..100%)	Low
487	KNX Channel 1-...	Green dimming value			1 byte	C	-	-	T	-	percentage (0..100%)	Low
488	KNX Channel 1-...	Blue dimming value			1 byte	C	-	-	T	-	percentage (0..100%)	Low
489	KNX Channel 1-...	Absolute colour temperature			2 bytes	C	-	-	T	-	absolute colour tempe...	Low
490	KNX Channel 1-...	Switch, status			1 bit	C	-	W	T	U	switch	Low
491	KNX Channel 1-...	Red brightness, status			1 byte	C	-	W	T	U	percentage (0..100%)	Low
492	KNX Channel 1-...	Green brightness, status			1 byte	C	-	W	T	U	percentage (0..100%)	Low
493	KNX Channel 1-...	Blue brightness, status			1 byte	C	-	W	T	U	percentage (0..100%)	Low
494	KNX Channel 1-...	Absolute colour temperature, status			2 bytes	C	-	W	T	U	absolute colour tempe...	Low
495	KNX Channel 1-...	Brightness value			1 byte	C	-	-	T	-	percentage (0..100%)	Low
497	KNX Channel 1-...	Brightness, status			1 byte	C	-	W	T	U	percentage (0..100%)	Low

RGBCW_3x1byte_Normal

Number ^	Name	Object Function	Description	Group Address	Length	C	R	W	T	U	Data Type	Priority
483	KNX Channel 1-...	Device online, status			1 bit	C	-	W	T	U	switch	Low
484	KNX Channel 1-...	Locking object			1 bit	C	-	W	-	-	enable	Low
485	KNX Channel 1-...	Switch			1 bit	C	-	-	T	-	switch	Low
486	KNX Channel 1-...	Red dimming value			1 byte	C	-	-	T	-	percentage (0..100%)	Low
487	KNX Channel 1-...	Green dimming value			1 byte	C	-	-	T	-	percentage (0..100%)	Low
488	KNX Channel 1-...	Blue dimming value			1 byte	C	-	-	T	-	percentage (0..100%)	Low
490	KNX Channel 1-...	Switch, status			1 bit	C	-	W	T	U	switch	Low
491	KNX Channel 1-...	Red brightness, status			1 byte	C	-	W	T	U	percentage (0..100%)	Low
492	KNX Channel 1-...	Green brightness, status			1 byte	C	-	W	T	U	percentage (0..100%)	Low
493	KNX Channel 1-...	Blue brightness, status			1 byte	C	-	W	T	U	percentage (0..100%)	Low
494	KNX Channel 1-...	Absolute colour temperature, status			2 bytes	C	-	W	T	U	absolute colour tempe...	Low
495	KNX Channel 1-...	Warm white brightness			1 byte	C	-	-	T	-	percentage (0..100%)	Low
496	KNX Channel 1-...	Cool white brightness			1 byte	C	-	-	T	-	percentage (0..100%)	Low
497	KNX Channel 1-...	Brightness, status			1 byte	C	-	W	T	U	percentage (0..100%)	Low

RGBCW_3x1byte_Normal_Directly(..) & Brightness+Colour Temperature

Number ^	Name	Object Function	Description	Group Address	Length	C	R	W	T	U	Data Type	Priority
483	KNX Channel 1-...	Device online, status			1 bit	C	-	W	T	U	switch	Low
484	KNX Channel 1-...	Locking object			1 bit	C	-	W	-	-	enable	Low
485	KNX Channel 1-...	Switch			1 bit	C	-	-	T	-	switch	Low
486	KNX Channel 1-...	Red dimming value			1 byte	C	-	-	T	-	percentage (0..100%)	Low
487	KNX Channel 1-...	Green dimming value			1 byte	C	-	-	T	-	percentage (0..100%)	Low
488	KNX Channel 1-...	Blue dimming value			1 byte	C	-	-	T	-	percentage (0..100%)	Low
490	KNX Channel 1-...	Switch, status			1 bit	C	-	W	T	U	switch	Low
491	KNX Channel 1-...	Red brightness, status			1 byte	C	-	W	T	U	percentage (0..100%)	Low
492	KNX Channel 1-...	Green brightness, status			1 byte	C	-	W	T	U	percentage (0..100%)	Low
493	KNX Channel 1-...	Blue brightness, status			1 byte	C	-	W	T	U	percentage (0..100%)	Low
495	KNX Channel 1-...	Warm white brightness			1 byte	C	-	-	T	-	percentage (0..100%)	Low
496	KNX Channel 1-...	Cool white brightness			1 byte	C	-	-	T	-	percentage (0..100%)	Low
497	KNX Channel 1-...	Warm white brightness, status			1 byte	C	-	W	T	U	percentage (0..100%)	Low
498	KNX Channel 1-...	Cool white brightness, status			1 byte	C	-	W	T	U	percentage (0..100%)	Low

RGBCW_3x1byte_Normal_Directly(..) & Warm/Cool white brightness

Number ^	Name	Object Function	Description	Group Address	Length	C	R	W	T	U	Data Type	Priority
483	KNX Channel 1-...	Device online, status			1 bit	C	-	W	T	U	switch	Low
484	KNX Channel 1-...	Locking object			1 bit	C	-	W	-	-	enable	Low
485	KNX Channel 1-...	Switch			1 bit	C	-	-	T	-	switch	Low
486	KNX Channel 1-...	RGB dimming value			3 bytes	C	-	-	T	-	RGB value 3x(0..255)	Low
489	KNX Channel 1-...	Absolute colour temperature			2 bytes	C	-	-	T	-	absolute colour tempe...	Low
490	KNX Channel 1-...	Switch, status			1 bit	C	-	W	T	U	switch	Low
491	KNX Channel 1-...	RGB brightness, status			3 bytes	C	-	W	T	U	RGB value 3x(0..255)	Low
494	KNX Channel 1-...	Absolute colour temperature, status			2 bytes	C	-	W	T	U	absolute colour tempe...	Low
495	KNX Channel 1-...	Brightness value			1 byte	C	-	-	T	-	percentage (0..100%)	Low
497	KNX Channel 1-...	Brightness, status			1 byte	C	-	W	T	U	percentage (0..100%)	Low

RGBCW_1x3byte_Normal

Number ^	Name	Object Function	Description	Group Address	Length	C	R	W	T	U	Data Type	Priority
483	KNX Channel 1-...	Device online, status			1 bit	C	-	W	T	U	switch	Low
484	KNX Channel 1-...	Locking object			1 bit	C	-	W	-	-	enable	Low
485	KNX Channel 1-...	Switch			1 bit	C	-	-	T	-	switch	Low
486	KNX Channel 1-...	RGB dimming value			3 bytes	C	-	-	T	-	RGB value 3x(0..255)	Low
490	KNX Channel 1-...	Switch, status			1 bit	C	-	W	T	U	switch	Low
491	KNX Channel 1-...	RGB brightness, status			3 bytes	C	-	W	T	U	RGB value 3x(0..255)	Low
494	KNX Channel 1-...	Absolute colour temperature, status			2 bytes	C	-	W	T	U	absolute colour tempe...	Low
495	KNX Channel 1-...	Warm white brightness			1 byte	C	-	-	T	-	percentage (0..100%)	Low
496	KNX Channel 1-...	Cool white brightness			1 byte	C	-	-	T	-	percentage (0..100%)	Low
497	KNX Channel 1-...	Brightness, status			1 byte	C	-	W	T	U	percentage (0..100%)	Low

RGBCW_1x3byte_Directly(..) &Brightness+Colour Temperature

Number ^	Name	Object Function	Description	Group Address	Length	C	R	W	T	U	Data Type	Priority
483	KNX Channel 1-...	Device online, status			1 bit	C	-	W	T	U	switch	Low
484	KNX Channel 1-...	Locking object			1 bit	C	-	W	-	-	enable	Low
485	KNX Channel 1-...	Switch			1 bit	C	-	-	T	-	switch	Low
486	KNX Channel 1-...	RGB dimming value			3 bytes	C	-	-	T	-	RGB value 3x(0..255)	Low
490	KNX Channel 1-...	Switch, status			1 bit	C	-	W	T	U	switch	Low
491	KNX Channel 1-...	RGB brightness, status			3 bytes	C	-	W	T	U	RGB value 3x(0..255)	Low
495	KNX Channel 1-...	Warm white brightness			1 byte	C	-	-	T	-	percentage (0..100%)	Low
496	KNX Channel 1-...	Cool white brightness			1 byte	C	-	-	T	-	percentage (0..100%)	Low
497	KNX Channel 1-...	Warm white brightness, status			1 byte	C	-	W	T	U	percentage (0..100%)	Low
498	KNX Channel 1-...	Cool white brightness, status			1 byte	C	-	W	T	U	percentage (0..100%)	Low

RGBCW_1x3byte_Directly(..) &Warm/Cool white brightness

Number ^	Name	Object Function	Description	Group Address	Length	C	R	W	T	U	Data Type	Priority
483	KNX Channel 1-...	Device online, status			1 bit	C	-	W	T	U	switch	Low
484	KNX Channel 1-...	Locking object			1 bit	C	-	W	-	-	enable	Low
485	KNX Channel 1-...	Switch			1 bit	C	-	-	T	-	switch	Low
490	KNX Channel 1-...	Switch, status			1 bit	C	-	W	T	U	switch	Low
494	KNX Channel 1-...	Absolute colour temperature, status			2 bytes	C	-	W	T	U	absolute colour tempe...	Low
495	KNX Channel 1-...	Warm white brightness			1 byte	C	-	-	T	-	percentage (0..100%)	Low
496	KNX Channel 1-...	Cool white brightness			1 byte	C	-	-	T	-	percentage (0..100%)	Low
497	KNX Channel 1-...	Brightness, status			1 byte	C	-	W	T	U	percentage (0..100%)	Low
495	KNX Channel 1-...	Warm white brightness		1 byte	C	-	-	T	-	-	percentage (0..100%)	低
496	KNX Channel 1-...	Cool white brightness		1 byte	C	-	-	T	-	-	percentage (0..100%)	低
497	KNX Channel 1-...	Warm white brightness, status		1 byte	C	-	W	T	U	-	percentage (0..100%)	低
498	KNX Channel 1-...	Cool white brightness, status		1 byte	C	-	W	T	U	-	percentage (0..100%)	低

Colour temperature dimming

Fig.6.10.3 “Colour and colour temperature control”communication object

NO.	Name	Object Function	Data Type	Flag	DPT
486	KNX Channel X-{{...}}	RGB dimming value	3byte	C,T	232.600 RGB value 3x(0..255)
491	KNX Channel X-{{...}}	RGB brightness, status	3byte	C,W,T,U	232.600 RGB value 3x(0..255)

These two communication objects are visible when 1x3byte for the RGB object type or 1x3byte for the RGBCW object type is selected. Apply to control brightness of colorful lamp.

Obj.486: Used for sending brightness value of RGB lamp to the bus.

Obj.491: Used for receiving brightness value of RGB lamp from bus.

3-Byte Code for RGB Dimming Object Data Type: U8 U8 U8, as follows:

3 _{MSB}	2	1 _{LSB}
R	G	B
UUUUUUUU	UUUUUUUU	UUUUUUUU

R: red dimming value; G: green dimming value; B: blue dimming value.

486	KNX Channel X-{{...}}	RGBW dimming value	6byte	C,T	251.600 DPT_Colour_RGBW
491	KNX Channel X-{{...}}	RGBW brightness, status	6byte	C,W,T,U	251.600 DPT_Colour_RGBW

These two communication objects are visible when 1x6byte for the RGBW object type is selected. Apply to control brightness of colorful lamp.

Obj.486: Used for sending brightness value of RGBW lamp to the bus.

Obj.491: Used for receiving brightness value of RGBW lamp from bus.

Encoding of the data type of the 6-byte RGBW dimming object: U8 U8 U8 U8 R8 R4 B4, as follows:

6 _{MSB}	5	4	3	2	1 _{LSB}
R	G	B	W	保留	r r r r mR mG mB mW
UUUUUUUU	UUUUUUUU	UUUUUUUU	UUUUUUUU	0000000 0	0000BBBB

R: red dimming value; G: green dimming value; B: blue dimming value; W: white dimming value;
 mR: determines whether the red dimming value is valid, 0 = invalid, 1 = valid;
 mG: determines whether the green dimming value is valid, 0 = invalid, 1 = valid;
 mB: determines whether the blue dimming value is valid, 0 = invalid, 1 = valid;
 mW: Determines whether the white dimming value is valid, 0 = invalid, 1 = valid.

486	KNX Channel X-{{...}}	Red dimming value	1byte	C,T	5.001 percentage(0..100%)
491	KNX Channel X-{{...}}	Red brightness, status	1byte	C,W,T,U	5.001 percentage(0..100%)

These two communication objects are visible when 3x1byte for the RGB object type or 4x1byte for the RGBW object type is selected. Apply to control brightness of lamp, and also support colour temperature adjustment. Telegrams: 0...100%

Obj.486: Used for sending brightness value of the control R (red) channel to the bus.

Obj.491: Used for receiving brightness status of the R (red) channel from the bus.

487	KNX Channel X-{{...}}	Green dimming value	1byte	C,T	5.001 percentage(0..100%)
492	KNX Channel X-{{...}}	Green brightness, status	1byte	C,W,T,U	5.001 percentage(0..100%)

These two communication objects are visible when 3x1byte for the RGB object type or 4x1byte for the RGBW object type is selected. Apply to control brightness of lamp. Telegrams: 0...100%

Obj.487: Used for sending brightness value of the control G (green) channel to the bus.

Obj.492: Used for receiving brightness status of the G (green) channel from the bus.

488	KNX Channel X-{{...}}	Blue dimming value	1byte	C,T	5.001 percentage(0..100%)
493	KNX Channel X-{{...}}	Blue brightness, status	1byte	C,W,T,U	5.001 percentage(0..100%)

These two communication objects are visible when 3x1byte for the RGB object type or 4x1byte for the RGBW object type is selected. Apply to control brightness of lamp. Telegrams: 0...100%

Obj.488: Used for sending brightness value of the control B (blue) channel to the bus.

Obj.493: Used for receiving brightness status of the B (blue) channel from the bus.

489	KNX Channel X-{{...}}	White dimming value	1byte	C,T	5.001 percentage(0..100%)
494	KNX Channel X-{{...}}	White brightness, status	1byte	C,W,T,U	5.001 percentage(0..100%)

These two communication objects are visible when 4x1byte or 3byte+1byte for the RGB object type is selected. Apply to control brightness of lamp. Telegrams: 0...100%

Obj.489: Used for sending brightness value of the control W (white) channel to the bus.

Obj.494: Used for receiving brightness status of the W (white) channel from the bus.

489	KNX Channel X-{{...}}	Absolute colour	2byte	C,T	7.600 absolute colour
		temperature	1byte		temperature
		Percentage colour			5.001
		temperature			percentage(0..100%)

These two communication objects apply to colour temperature adjustment. Telegrams: 2000...7000 K

Under normal control, used for sending the control telegram of the colour temperature to the bus.					
494	KNX Channel X-{{...}}	Absolute colour temperature, status	2byte	C,W,T,U	7.600 absolute colour temperature
<p>The two communication objects apply to colour temperature adjustment. Telegrams: 2000...7000 K</p> <p>Under normal or directly control & (Brightness+Colour Temperature), used for receiving the control telegram of the colour temperature from bus.</p>					
494	KNX Channel X-{{...}}	Percentage colour temperature, status	1byte	C,W,T,U	5.001 percentage(0..100%)
<p>The two communication objects apply to colour temperature adjustment. Telegrams: 2000...7000 K</p> <p>Under normal control, used for sending the control telegram of the colour temperature to the bus.</p>					
495	KNX Channel X-{{...}}	Brightness value	1byte	C,T	5.001 percentage(0..100%)
497	KNX Channel X-{{...}}	Brightness, status	1byte	C,W,T,U	5.001 percentage(0..100%)
<p>These two communication objects apply to brightness control. Telegrams: 0...100%</p> <p>Obj.495: Under normal control, used for sending the dimming telegram of the brightness value to the bus, that is, sending the brightness value.</p> <p>Obj.497: Under normal or directly control & (Brightness+Colour Temperature), used for receiving the brightness status responded from the dimming actuator.</p>					
495	KNX Channel X-{{...}}	Warm white brightness	1byte	C,T	5.001 percentage(0..100%)
497	KNX Channel X-{{...}}	Warm white brightness, status	1byte	C,W,T,U	5.001 percentage(0..100%)

Under the directly control, these two communication objects apply to warm white brightness control. Telegrams: 0...100%

Obj.495: Under directly control, used for sending the warm white dimming telegram to the bus, that is, sending the warm white brightness value.

Obj.497: Under directly control & (Warm/Cool white brightness), used for receiving the warm white brightness status responded from the dimming actuator.

496	KNX Channel X-{{...}}	Cool white brightness	1byte	C,T	5.001 percentage(0..100%)
498	KNX Channel X-{{...}}	Cool white brightness, status	1byte	C,W,T,U	5.001 percentage(0..100%)

Under the directly control, these two communication objects apply to cool white brightness control. Telegrams: 0...100%

Obj.496: Under directly control, used for sending the cool white dimming telegram to the bus, that is, sending the cool brightness value.

Obj.498: Under directly control & (Warm/Cool white brightness), used for receiving the cool white brightness status responded from the dimming actuator.

485	KNX Channel X-{{...}}	Switch	1bit	C,T	1.001 switch
490	KNX Channel X-{{...}}	Switch, status	1bit	C,W,T,U	1.001 switch

This communication object apply to control light switches. Telegrams:

1—switch on the light

0—switch off the light

Obj.485: Used for sending On/Off telegrams to the bus, to control the light on/off.

Obj.490: Used for receiving On/Off status responded from other bus devices.

Table 6.10.3 “Colour and colour temperature control”communication object

6.10.4 “Curtain and Blind” Communication object

485	KNX Channel 1-...	Open/Close	1 bit	C - W T -	open/close	低
486	KNX Channel 1-...	Stop	1 bit	C - W T -	step	低
487	KNX Channel 1-...	Curtain position	1 byte	C - - T -	percentage (0..100%)	低
490	KNX Channel 1-...	Curtain position, status	1 byte	C - W T U	percentage (0..100%)	低

Curtain position

485	KNX Channel 1-...	Up/Down	1 bit	C - W T -	up/down	低
486	KNX Channel 1-...	Stop	1 bit	C - W T -	step	低
487	KNX Channel 1-...	Blind position	1 byte	C - - T -	percentage (0..100%)	低
490	KNX Channel 1-...	Blind position, status	1 byte	C - W T U	percentage (0..100%)	低

Roller blind position

485	KNX Channel 1-...	Up/Down	1 bit	C - W T -	up/down	低
486	KNX Channel 1-...	Stop/Slat adj.	1 bit	C - W T -	step	低
487	KNX Channel 1-...	Blind position	1 byte	C - - T -	percentage (0..100%)	低
488	KNX Channel 1-...	Slat position	1 byte	C - - T -	percentage (0..100%)	低
490	KNX Channel 1-...	Blind position, status	1 byte	C - W T U	percentage (0..100%)	低
491	KNX Channel 1-...	Slat position, status	1 byte	C - W T U	percentage (0..100%)	低

Venetian blind position and slat

485	KNX Channel 1-...	Open/Close	1 bit	C - W T -	open/close	低
486	KNX Channel 1-...	Stop	1 bit	C - W T -	step	低

Curtain step/move

485	KNX Channel 1-...	Up/Down	1 bit	C - W T -	up/down	低
486	KNX Channel 1-...	Stop	1 bit	C - W T -	step	低

Roller blind step/move

Fig.6.10.4 “Curtain and blind” communication object

NO.	Name	Object Function	Data Type	Flag	DPT
485	KNX Channel X-{{...}}	Open/Close	1bit	C,W,T	1.009 open/close
486	KNX Channel X-{{...}}	Stop	1bit	C,W,T	1.007 step
487	KNX Channel X-{{...}}	Curtain position	1byte	C,T	5.001 percentage(0..100%)
490	KNX Channel X-{{...}}	Curtain position, status	1byte	C,W,T,U	5.001 percentage(0..100%)

Curtain position: apply to open and close curtain. Support to open, close, stop, position adjustment and position status feedback.

Obj.485: Used for sending the telegram to the bus, to control curtain open/close. Telegrams:

1—Close the curtain

0—Open the curtain

Obj.486: Used for sending the telegram to the bus, to stop curtain movement. Telegrams:

1—Stop

Obj.487: Used for sending a telegram to control the position of the curtain to the bus. Telegrams: 0...100%

Obj.490: Used for receiving a curtain position status in response to the window curtain actuator on the bus. Telegrams: 0...100%

485	KNX Channel X-{{...}}	Up/Down	1bit	C,W,T	1.008 up/down
486	KNX Channel X-{{...}}	Stop	1bit	C,W,T	1.007 step
487	KNX Channel X-{{...}}	Blind position	1byte	C,T	5.001 percentage(0..100%)
490	KNX Channel X-{{...}}	Blind position, status	1byte	C,W,T,U	5.001 percentage(0..100%)

Roller blind position: apply to a roller blind without slat. Support to up, down, stop, position adjustment and position status feedback.

Obj.485: Used for sending the telegram to the bus, to control blind up/down. Telegrams:

1—Move down

0—Move up

Obj.487: Used for sending a telegram to control the position of the roller blind to the bus. Telegrams: 0...100%

Obj.490: Used for receiving a roller blind position status in response to the roller blind actuator on the bus. Telegrams: 0...100%

Obj.486 is the same as above.

485	KNX Channel X-{{...}}	Up/Down	1bit	C,W,T	1.008 up/down
486	KNX Channel X-{{...}}	Stop/Slat adj.	1bit	C,W,T	1.007 step
487	KNX Channel X-{{...}}	Blind position	1byte	C,T	5.001 percentage(0..100%)
488	KNX Channel X-{{...}}	Slat position	1byte	C,T	5.001 percentage(0..100%)
490	KNX Channel X-{{...}}	Blind position, status	1byte	C,W,T,U	5.001 percentage(0..100%)
491	KNX Channel X-{{...}}	Slat position, status	1byte	C,W,T,U	5.001 percentage(0..100%)

Venetian blind position and slat: apply to a blind with slat. Support to up, down, stop, position and slat adjustment, position and slat status feedback.

Obj.485、 Obj.487 and Obj.490 are same as above.

Obj.486: Used for sending a telegram to the bus to stop the curtain movement or adjust the slat angle. Telegrams:

1——Stop/Slat adj. Down

0——Stop/Slat adj. Up

Obj.488: Used for sending a telegram to control the position of the blind to the bus. Telegrams: 0...100%

Obj.491: Used for receiving a blind position status in response to the blind actuator on the bus. Telegrams: 0...100%

485	KNX Channel X-{{...}}	Open/Close	1bit	C, W,T	1.009 open/close
486	KNX Channel X-{{...}}	Stop	1bit	C, W,T	1.007 step
<p>Curtain step/move: these two communication objects apply to open and close curtain. Support to open, close, stop.</p> <p>Obj.485: Used for sending the telegram to the bus, to control curtain open/close. Telegrams:</p> <p style="padding-left: 40px;">1—Close the curtain</p> <p style="padding-left: 40px;">0—Open the curtain</p> <p>Obj.486: Used for sending the telegram to the bus, to stop curtain movement. Telegrams:</p> <p style="padding-left: 40px;">1—Stop</p>					
485	KNX Channel X-{{...}}	Up/Down	1bit	C, W,T	1.008 up/down
486	KNX Channel X-{{...}}	Stop	1bit	C, W,T	1.007 step
<p>Roller blind step/move: these two communication objects apply to roller blind. Support to up, down, stop.</p> <p>Obj.485: Used for sending the telegram to the bus, to control blind up/down. Telegrams:</p> <p style="padding-left: 40px;">1—Move down</p> <p style="padding-left: 40px;">0—Move up</p> <p>Obj.486 is the same as above.</p>					

Table 6.10.4 "Curtain and blind" communication object

6.10.5 "Air conditioner control" Communication object

Number ^	Name	Object Function	Description	Group Address	Length	C	R	W	T	U	Data Type	Priority
483	KNX Channel 1-...	Device online, status			1 bit	C	-	W	T	U	switch	Low
484	KNX Channel 1-...	Locking object			1 bit	C	-	W	-	-	enable	Low
485	KNX Channel 1-...	Power on/off			1 bit	C	-	-	T	-	switch	Low
486	KNX Channel 1-...	Current setpoint adjustment			2 bytes	C	-	-	T	-	temperature (°C)	Low
488	KNX Channel 1-...	Fan speed			1 byte	C	-	-	T	-	percentage (0.100%)	Low
491	KNX Channel 1-...	Control mode			1 byte	C	-	-	T	-	HVAC control mode	Low
492	KNX Channel 1-...	Power on/off, status			1 bit	C	-	W	T	U	switch	Low
493	KNX Channel 1-...	External temperature sensor			2 bytes	C	-	W	T	U	temperature (°C)	Low
494	KNX Channel 1-...	Current temperature setpoint, status			2 bytes	C	-	W	T	U	temperature (°C)	Low
496	KNX Channel 1-...	Fan speed, status			1 byte	C	-	W	T	U	percentage (0.100%)	Low
498	KNX Channel 1-...	Control mode, status			1 byte	C	-	W	T	U	HVAC control mode	Low
500	KNX Channel 1-...	Timer			1 bit	C	-	W	-	-	enable	Low

Air conditioner

485	KNX Channel 1-...	Power on/off			1 bit	C	-	-	T	-	switch	低
486	KNX Channel 1-...	Current setpoint adjustment			1 byte	C	-	-	T	-	counter pulses (0..255)	低
488	KNX Channel 1-...	Fan speed			1 byte	C	-	-	T	-	percentage (0.100%)	低
489	KNX Channel 1-...	Vanes swing (1-swing,0-stop)			1 bit	C	-	-	T	-	start/stop	低
491	KNX Channel 1-...	Control mode			1 byte	C	-	-	T	-	HVAC control mode	低
492	KNX Channel 1-...	Power on/off, status			1 bit	C	-	W	T	U	switch	低
493	KNX Channel 1-...	External temperature sensor			2 bytes	C	-	W	T	U	temperature (°C)	低
494	KNX Channel 1-...	Current temperature setpoint, status			1 byte	C	-	W	T	U	counter pulses (0..255)	低
496	KNX Channel 1-...	Fan speed, status			1 byte	C	-	W	T	U	percentage (0.100%)	低
497	KNX Channel 1-...	Vanes swing (1-swing,0-stop), status			1 bit	C	-	W	T	U	start/stop	低
498	KNX Channel 1-...	Control mode, status			1 byte	C	-	W	T	U	HVAC control mode	低
500	KNX Channel 1-...	Timer			1 bit	C	-	W	-	-	enable	低

Air conditioner(with swing)

Fig.6.10.5 "Air conditioner control"communication object

NO.	Name	Object Function	Data Type	Flag	DPT
485	KNX Channel X-{{...}}	Power on/off	1bit	C,T	1.001 switch
The communication object is used to send the power on/off telegram of air condition, to control air condition power on/off on the KNX bus.					
486	KNX Channel X-{{...}}	Current setpoint adjustment	2byte 1byte	C,T	9.001 temperature 5.010 counter pulses
The communication object is used to adjust setpoint temperature via the bus, and send telegram value to the bus.					

<p>Note: the object type is set by parameters, 2byte is suitable for KNX standard, 1byte is KNX non-standard, usually suitable for some customized control classes, the telegram value is the actual temperature value, such as 17 °C telegram value is 17 (decimal number).</p>					
488	KNX Channel X-{{...}}	Fan speed	1byte	C,T	5.001 percentage 5.100 fan stage
<p>The communication object is used to send control telegram of each fan speed to the bus. Telegram value is determined by parameter setting datatype.</p>					
489	KNX Channel X-{{...}}	Vanes swing (1-swing,0-stop)	1bit	C,T	1.010 start/stop
<p>This communication object is visible when "Air conditioner (with swing)" is selected.Used to send telegram controlling vanes swing to the bus. Telegrams:</p>					
491	KNX Channel X-{{...}}	Control mode	1byte	C,T	20.105 HVAC control mode
<p>The communication object is used to send control telegram of each air condition mode to the bus. Different telegram means different control mode. 0-Auto, 1- Heating, 3-Cooling, 9-Fan, 14-Dehumidity, other reserved.</p>					
492	KNX Channel X-{{...}}	Power on/off, status	1bit	C,W ,T,U	1.001 switch
<p>The communication object is used to receive the power on/off telegram of air condition from the bus, and feedback to screen display. Telegrams:</p> <p style="text-align: center;">1—On</p> <p style="text-align: center;">0—Off</p>					
493	KNX Channel X-{{...}}	External temperature sensor	2byte	C,W ,T,U	9.001 temperature
<p>The communication object is used to receive the room temperature from the bus, and send read request cyclically, and feedback to screen display.</p>					

494	KNX Channel X-{{...}}	Current temperature setpoint, status	2byte 1byte	C,W ,T,U	9.001 temperature 5.010 counter pulses
The communication object is used to receive the current setpoint temperature from the bus, and feedback to screen display.					
496	KNX Channel X-{{...}}	Fan speed, status	1byte	C,W ,T,U	5.001 percentage 5.100 fan stage
The communication object is used to receive the current fan speed from the bus, and feedback to screen display. Telegram value is determined by parameter setting datatype.					
497	KNX Channel X-{{...}}	Vanes swing (1-swing,0-stop), status	1bit	C,W ,T,U	1.010 start/stop
This communication object is visible when "Air conditioner (with swing)" is selected. Used to receive vanes swing status from the bus. Telegrams: 1—Swing 0—Stop					
498	KNX Channel X-{{...}}	Control mode, status	1byte	C,W ,T,U	20.105 HVAC control mode
The communication object is used to receive the current control mode from the bus, and feedback to screen display. Different telegram means different control mode. 0-Auto, 1- Heating, 3-Cooling, 9-Fan, 14-Dehumidity, other reserved.					
500	KNX Channel X-{{...}}	Timer	1bit	C,W	1.003 enable
The communication object is visible when timer function enabled. Used to turn on/off the timing via the bus. Telegrams: 1-On 2-Off					

Table 6.10.5 "Air conditioner control" communication object

6.10.6 “Room temperature unit control” Communication object

Number ^	Name	Object Function	Description	Group Address	Length	C	R	W	T	U	Data Type	Priority
483	KNX Channel 1-...	Device online, status			1 bit	C	-	W	T	U	switch	Low
484	KNX Channel 1-...	Locking object			1 bit	C	-	W	-	-	enable	Low
486	KNX Channel 1-...	Current setpoint adjustment			2 bytes	C	-	-	T	-	temperature (°C)	Low
487	KNX Channel 1-...	Current setpoint adjustment(1bit)			1 bit	C	-	-	T	-	step	Low
490	KNX Channel 1-...	Heating/Cooling mode			1 bit	C	-	-	T	-	cooling/heating	Low
493	KNX Channel 1-...	External temperature sensor			2 bytes	C	-	W	T	U	temperature (°C)	Low
494	KNX Channel 1-...	Current setpoint adjustment, status			2 bytes	C	-	W	T	U	temperature (°C)	Low
495	KNX Channel 1-...	Current setpoint display, status			2 bytes	C	-	W	T	U	temperature (°C)	Low
498	KNX Channel 1-...	Heating/Cooling mode, status			1 bit	C	-	W	T	U	cooling/heating	Low
500	KNX Channel 1-...	Timer			1 bit	C	-	W	-	-	enable	Low

Room temperature unit

Number ^	Name	Object Function	Description	Group Address	Length	C	R	W	T	U	Data Type	Priority
483	KNX Channel 1-...	Device online, status			1 bit	C	-	W	T	U	switch	Low
484	KNX Channel 1-...	Locking object			1 bit	C	-	W	-	-	enable	Low
485	KNX Channel 1-...	Power on/off			1 bit	C	-	-	T	-	switch	Low
486	KNX Channel 1-...	Current setpoint adjustment			2 bytes	C	-	-	T	-	temperature (°C)	Low
487	KNX Channel 1-...	Current setpoint adjustment(1bit)			1 bit	C	-	-	T	-	step	Low
490	KNX Channel 1-...	Heating/Cooling mode			1 bit	C	-	-	T	-	cooling/heating	Low
492	KNX Channel 1-...	Power on/off, status			1 bit	C	-	W	-	-	switch	Low
493	KNX Channel 1-...	External temperature sensor			2 bytes	C	-	W	T	U	temperature (°C)	Low
494	KNX Channel 1-...	Current setpoint adjustment, status			2 bytes	C	-	W	T	U	temperature (°C)	Low
495	KNX Channel 1-...	Current setpoint display, status			2 bytes	C	-	W	T	U	temperature (°C)	Low
498	KNX Channel 1-...	Heating/Cooling mode, status			1 bit	C	-	W	T	U	cooling/heating	Low
500	KNX Channel 1-...	Timer			1 bit	C	-	W	-	-	enable	Low

Room temperature unit(with on/off)

Number ^	Name	Object Function	Description	Group Address	Length	C	R	W	T	U	Data Type	Priority
483	KNX Channel 1-...	Device online, status			1 bit	C	-	W	T	U	switch	Low
484	KNX Channel 1-...	Locking object			1 bit	C	-	W	-	-	enable	Low
486	KNX Channel 1-...	Current setpoint adjustment			2 bytes	C	-	-	T	-	temperature (°C)	Low
487	KNX Channel 1-...	Current setpoint adjustment(1bit)			1 bit	C	-	-	T	-	step	Low
490	KNX Channel 1-...	Heating/Cooling mode			1 bit	C	-	-	T	-	cooling/heating	Low
491	KNX Channel 1-...	Operation mode			1 byte	C	-	-	T	-	HVAC mode	Low
493	KNX Channel 1-...	External temperature sensor			2 bytes	C	-	W	T	U	temperature (°C)	Low
494	KNX Channel 1-...	Current setpoint adjustment, status			2 bytes	C	-	W	T	U	temperature (°C)	Low
495	KNX Channel 1-...	Current setpoint display, status			2 bytes	C	-	W	T	U	temperature (°C)	Low
498	KNX Channel 1-...	Heating/Cooling mode, status			1 bit	C	-	W	T	U	cooling/heating	Low
499	KNX Channel 1-...	Operation mode, status			1 byte	C	-	W	T	U	HVAC mode	Low
500	KNX Channel 1-...	Timer			1 bit	C	-	W	-	-	enable	Low

Room temperature unit(with operation mode)

Number ^	Name	Object Function	Description	Group Address	Length	C	R	W	T	U	Data Type	Priority
483	KNX Channel 1-...	Device online, status			1 bit	C	-	W	T	U	switch	Low
484	KNX Channel 1-...	Locking object			1 bit	C	-	W	-	-	enable	Low
485	KNX Channel 1-...	Power on/off			1 bit	C	-	-	T	-	switch	Low
486	KNX Channel 1-...	Current setpoint adjustment			2 bytes	C	-	-	T	-	temperature (°C)	Low
487	KNX Channel 1-...	Current setpoint adjustment(1bit)			1 bit	C	-	-	T	-	step	Low
490	KNX Channel 1-...	Heating/Cooling mode			1 bit	C	-	-	T	-	cooling/heating	Low
491	KNX Channel 1-...	Operation mode			1 byte	C	-	-	T	-	HVAC mode	Low
492	KNX Channel 1-...	Power on/off, status			1 bit	C	-	W	-	-	switch	Low
493	KNX Channel 1-...	External temperature sensor			2 bytes	C	-	W	T	U	temperature (°C)	Low
494	KNX Channel 1-...	Current setpoint adjustment, status			2 bytes	C	-	W	T	U	temperature (°C)	Low
495	KNX Channel 1-...	Current setpoint display, status			2 bytes	C	-	W	T	U	temperature (°C)	Low
498	KNX Channel 1-...	Heating/Cooling mode, status			1 bit	C	-	W	T	U	cooling/heating	Low
499	KNX Channel 1-...	Operation mode, status			1 byte	C	-	W	T	U	HVAC mode	Low
500	KNX Channel 1-...	Timer			1 bit	C	-	W	-	-	enable	Low

Room temperature unit(with on/off & operation mode)

Number ^	Name	Object Function	Description	Group Address	Length	C	R	W	T	U	Data Type	Priority
483	KNX Channel 1-...	Device online, status			1 bit	C	-	W	T	U	switch	Low
484	KNX Channel 1-...	Locking object			1 bit	C	-	W	-	-	enable	Low
486	KNX Channel 1-...	Current setpoint adjustment			2 bytes	C	-	-	T	-	temperature (°C)	Low
487	KNX Channel 1-...	Current setpoint adjustment(1bit)			1 bit	C	-	-	T	-	step	Low
488	KNX Channel 1-...	Fan speed			1 byte	C	-	-	T	-	percentage (0..100%)	Low
490	KNX Channel 1-...	Heating/Cooling mode			1 bit	C	-	-	T	-	cooling/heating	Low
491	KNX Channel 1-...	Operation mode			1 byte	C	-	-	T	-	HVAC mode	Low
493	KNX Channel 1-...	External temperature sensor			2 bytes	C	-	W	T	U	temperature (°C)	Low
494	KNX Channel 1-...	Current setpoint adjustment, status			2 bytes	C	-	W	T	U	temperature (°C)	Low
495	KNX Channel 1-...	Current setpoint display, status			2 bytes	C	-	W	T	U	temperature (°C)	Low
496	KNX Channel 1-...	Fan speed, status			1 byte	C	-	W	T	U	percentage (0..100%)	Low
498	KNX Channel 1-...	Heating/Cooling mode, status			1 bit	C	-	W	T	U	cooling/heating	Low
499	KNX Channel 1-...	Operation mode, status			1 byte	C	-	W	T	U	HVAC mode	Low
500	KNX Channel 1-...	Timer			1 bit	C	-	W	-	-	enable	Low

Room temperature unit(with operation mode & fan speed)

Number ^	Name	Object Function	Description	Group Address	Length	C	R	W	T	U	Data Type	Priority
483	KNX Channel 1-...	Device online, status			1 bit	C	-	W	T	U	switch	Low
484	KNX Channel 1-...	Locking object			1 bit	C	-	W	-	-	enable	Low
485	KNX Channel 1-...	Power on/off			1 bit	C	-	-	T	-	switch	Low
486	KNX Channel 1-...	Current setpoint adjustment			2 bytes	C	-	-	T	-	temperature (°C)	Low
487	KNX Channel 1-...	Current setpoint adjustment(1bit)			1 bit	C	-	-	T	-	step	Low
488	KNX Channel 1-...	Fan speed			1 byte	C	-	-	T	-	percentage (0..100%)	Low
490	KNX Channel 1-...	Heating/Cooling mode			1 bit	C	-	-	T	-	cooling/heating	Low
491	KNX Channel 1-...	Operation mode			1 byte	C	-	-	T	-	HVAC mode	Low
492	KNX Channel 1-...	Power on/off, status			1 bit	C	-	W	-	-	switch	Low
493	KNX Channel 1-...	External temperature sensor			2 bytes	C	-	W	T	U	temperature (°C)	Low
494	KNX Channel 1-...	Current setpoint adjustment, status			2 bytes	C	-	W	T	U	temperature (°C)	Low
495	KNX Channel 1-...	Current setpoint display, status			2 bytes	C	-	W	T	U	temperature (°C)	Low
496	KNX Channel 1-...	Fan speed, status			1 byte	C	-	W	T	U	percentage (0..100%)	Low
498	KNX Channel 1-...	Heating/Cooling mode, status			1 bit	C	-	W	T	U	cooling/heating	Low
499	KNX Channel 1-...	Operation mode, status			1 byte	C	-	W	T	U	HVAC mode	Low
500	KNX Channel 1-...	Timer			1 bit	C	-	W	-	-	enable	Low

Room temperature unit(with on/off & operation mode & fan speed)

Fig.6.10.6 "Room temperature unit control" communication object

NO.	Name	Object Function	Data Type	Flag	DPT
485	KNX Channel X-{{...}}	Power on/off	1bit	C,T	1.001 switch
<p>The communication object is used to send the power on/off telegram of RTC, to control RTC power on/off on the KNX bus.</p> <p>The system needs to return to the status before voltage failure when voltage recovery, and send status request of function point: control mode, operation mode, fan speed, setpoint temperature, external temperature sensor.</p>					
486	KNX Channel X-{{...}}	Current setpoint adjustment	2byte	C,T	9.001 temperature
<p>The communication object is used to send the power on/off telegram of RTC, to control RTC power on/off on the KNX bus.</p> <p>The system needs to return to the status before voltage failure when voltage recovery, and send status request of function point: control mode, operation mode, fan speed, setpoint temperature, external temperature sensor.</p>					
487	KNX Channel X-{{...}}	Current setpoint adjustment(1bit)	1bit	C,T	1.007 step
<p>The communication object is visible when object datatype of setpoint temperature adjustment is 1 bit. Through the screen to adjust setpoint temperature, 1 bit object suitable for relatively adjusts, and sent telegram value to the bus.</p> <p style="text-align: center;">1——Increase setpoint</p> <p style="text-align: center;">0——Decrease setpoint</p>					
488	KNX Channel X-{{...}}	Fan speed	1byte	C,T	5.001 percentage 5.100 fan stage
<p>The communication object is used to send control telegram of each fan speed to the bus. Telegram value is determined by parameter setting datatype.</p>					

489	KNX Channel X-{{...}}	Fan automatic operation	1bit	C,T	1.003 enable
<p>The communication object is used to send control telegram of fan automatic operation to the bus.</p> <p>Telegrams:</p> <p style="padding-left: 40px;">1—Activate auto</p> <p style="padding-left: 40px;">0—Cancel auto</p>					
490	KNX Channel X-{{...}}	Heating/Cooling mode	1bit	C,T	1.100 cooling/heating
<p>The communication object is used to send telegram for switching cooling and heating functions to the bus. Telegrams:</p> <p style="padding-left: 40px;">1—Heating</p> <p style="padding-left: 40px;">0—Cooling</p>					
491	KNX Channel X-{{...}}	Operation mode	1byte	C,T	20.102 HVAC mode
<p>The communication object is used to send the telegram of the room operation mode to the bus.</p> <p>Different telegram means different control mode:</p> <p style="padding-left: 40px;">1-Comfort, 2-Standby, 3-Economy, 4-Protection, other reserved.</p>					
492	KNX Channel X-{{...}}	Power on/off, status	1bit	C,W	1.001 switch
<p>The communication object is used to receive the power on/off telegram of RTC from the bus, and feedback to screen display. Telegrams:</p> <p style="padding-left: 40px;">1—On</p> <p style="padding-left: 40px;">0—Off</p>					
493	KNX Channel X-{{...}}	External temperature sensor	2byte	C,W, T,U	9.001 temperature
<p>The communication object is visible when the external sensor is selected.Used to receive the room temperature from the bus, and send read request cyclically, and feedback to screen display.</p>					

494	KNX Channel X-{{...}}	Current setpoint adjustment, status	2byte	C,W, T,U	9.001 temperature
The communication object is used to receive the current setpoint temperature from the bus, and feedback to screen display.					
495	KNX Channel X-{{...}}	Current setpoint display, status	2byte	C,W, T,U	9.001 temperature
The communication object is visible when Setpoint temperature is selected for the parameter "Interface display temperature". Used to receive the current setpoint temperature and to display it on the screen.					
496	KNX Channel X-{{...}}	Fan speed, status	1byte	C,W, T,U	5.001 percentage 5.100 fan stage
The communication object is used to receive the current fan speed from the bus, and feedback to screen display. Telegram value is determined by parameter setting datatype.					
497	KNX Channel X-{{...}}	Fan automatic operation, status	1bit	C,W, T,U	1.003 enable
The communication object is used to receive feedback status of fan automatic operation from the bus. Telegrams: 1—Automatic 0—Cancel automatic					
498	KNX Channel X-{{...}}	Heating/Cooling mode, status	1bit	C,W, T,U	1.100 cooling/heating
The communication object is used to receive the heating and cooling status from the bus, and feedback to screen display. Telegrams: 1 —Heating 0 —Cooling					

499	KNX Channel X-{{...}}	Operation mode, status	1byte	C,W, T,U	20.102 mode	HVAC
<p>The communication object is used to receive the telegram of RTC operation mode from the bus. Different telegram means different control mode: 1-Comfort, 2-Standby, 3-Economy, 4-Protection, other reserved.</p>						
500	KNX Channel X-{{...}}	Timer	1bit	C,W	1.003 enable	
<p>The communication object is visible when timer function enabled. Used to turn on/off the timing via the bus.</p>						

Table 6.10.6 "Room temperature control" communication object

6.10.7 “Ventilation system control” Communication object

Number ^	Name	Object Function	Description	Group Address	Length	C	R	W	T	U	Data Type	Priority
483	KNX Channel 1-...	Device online, status			1 bit	C	-	W	T	U	switch	Low
484	KNX Channel 1-...	Locking object			1 bit	C	-	W	-	-	enable	Low
485	KNX Channel 1-...	Power on/off			1 bit	C	-	-	T	-	switch	Low
486	KNX Channel 1-...	Filter timer counter			2 bytes	C	-	-	T	-	time (h)	Low
487	KNX Channel 1-...	Filter alarm			1 bit	C	-	-	T	-	alarm	Low
488	KNX Channel 1-...	Fan speed			1 byte	C	-	-	T	-	percentage (0..100%)	Low
490	KNX Channel 1-...	Heat recovery			1 bit	C	-	-	T	-	enable	Low
492	KNX Channel 1-...	Power on/off, status			1 bit	C	-	W	-	-	switch	Low
493	KNX Channel 1-...	Filter timer counter change			2 bytes	C	-	W	-	-	time (h)	Low
496	KNX Channel 1-...	Fan speed, status			1 byte	C	-	W	-	-	percentage (0..100%)	Low
498	KNX Channel 1-...	Heat recovery, status			1 bit	C	-	W	-	-	enable	Low
499	KNX Channel 1-...	Filter timer reset			1 bit	C	-	W	-	-	reset	Low

Ventilation system

Number ^	Name	Object Function	Description	Group Address	Length	C	R	W	T	U	Data Type	Priority
483	KNX Channel 1-...	Device online, status			1 bit	C	-	W	T	U	switch	Low
484	KNX Channel 1-...	Locking object			1 bit	C	-	W	-	-	enable	Low
485	KNX Channel 1-...	Power on/off			1 bit	C	-	-	T	-	switch	Low
486	KNX Channel 1-...	Filter timer counter			2 bytes	C	-	-	T	-	time (h)	Low
487	KNX Channel 1-...	Filter alarm			1 bit	C	-	-	T	-	alarm	Low
488	KNX Channel 1-...	Fan speed			1 byte	C	-	-	T	-	percentage (0..100%)	Low
489	KNX Channel 1-...	Fan automatic operation			1 bit	C	-	-	T	-	enable	Low
490	KNX Channel 1-...	Heat recovery			1 bit	C	-	-	T	-	enable	Low
492	KNX Channel 1-...	Power on/off, status			1 bit	C	-	W	-	-	switch	Low
493	KNX Channel 1-...	Filter timer counter change			2 bytes	C	-	W	-	-	time (h)	Low
494	KNX Channel 1-...	PM 2.5 value			2 bytes	C	-	W	T	U	pulses	Low
496	KNX Channel 1-...	Fan speed, status			1 byte	C	-	W	-	-	percentage (0..100%)	Low
497	KNX Channel 1-...	Fan automatic operation, status			1 bit	C	-	W	-	-	enable	Low
498	KNX Channel 1-...	Heat recovery, status			1 bit	C	-	W	-	-	enable	Low
499	KNX Channel 1-...	Filter timer reset			1 bit	C	-	W	-	-	reset	Low

Ventilation system(with auto fan speed)

Fig.6.10.7”Ventilation system control”communication object

NO.	Name	Object Function	Data Type	Flag	DPT
485	KNX Channel X-{{...}}	Power on/off	1bit	C,T	1.001 switch
<p>The communication object is used to send the power on/off telegram of ventilation to KNX bus.</p> <p>Telegrams:</p> <p style="padding-left: 40px;">1—On</p> <p style="padding-left: 40px;">0—Off</p>					
486	KNX Channel X-{{...}}	Filter timer counter	2byte	C,T	7.007 time(h)
<p>The communication object is used to count the length of the filter. When the count value changes, it can be sent to the bus. The unit of filter time counter is in hours.</p>					
487	KNX Channel X-{{...}}	Filter alarm	1bit	C,T	1.005 alarm
<p>When the filter is used for longer than the set value, the communication object issues an alarm to remind the user to replace the filter. Telegram value:</p> <p style="padding-left: 40px;">1—Alarm</p> <p style="padding-left: 40px;">1— No alarm</p>					
488	KNX Channel X-{{...}}	Fan speed	1byte	C,T	5.001 percentage 5.100 fan stage
<p>该通讯对象用于发送各档风速的控制报文到总线上。报文值由 Parameter 设置的数据 Data Type 决定</p>					
489	KNX Channel X-{{...}}	Fan automatic operation	1bit	C,T	1.003 enable
<p>The communication object is visible when Ventilation system (with auto fan speed) is selected.</p> <p>Used to enable the automatic operation of ventilation system.</p> <p>After the device is reset or programmed, the automatic operation is not enabled by default. Turn off the machine and manually adjust the fan speed. The scene can exit the automatic operation.</p> <p>There is no parameter definition, default 1 - active, 0 - inactive.</p>					

490	KNX Channel X-{{...}}	Heat recovery	1bit	C,T	1.003 enable
<p>The communication object is visible when the "Heat recovery function" parameter is enabled.Used to send the control command of on/off ventilation system heat recovery, and the status feedback value can also be received. Telegram values:</p> <p style="text-align: center;">1—On</p> <p style="text-align: center;">0—Off</p>					
492	KNX Channel X-{{...}}	Power on/off, status	1bit	C,W	1.001 switch
<p>The communication object is used to receive the power on/off telegram of ventilation from the bus.</p>					
493	KNX Channel X-{{...}}	Filter timer counter change	2byte	C,W	7.007 time(h)
<p>The communication object is visible when the"Filter timer counter" parameter is enabled.Used to modify the time length of the filter usage by the bus.</p>					
494	KNX Channel X-{{...}}	CO2 value	2byte	C,W, T,U	7.001 pulse 9.030 concentration(ug/m3) 9.008 parts/million(ppm)
<p>This communication object is visible when Ventilation system (with auto fan speed) is selected.The data type of the object is set by the parameter.</p> <p>The communication object is used to receive the input of the CO2 value and get the corresponding value from the bus to be updated to the display in ppm. Range: 0~4000ppm</p> <p>If the control value of the automatic operation is CO2, the ventilation system can be set to automatically adjust the fan speed according to the concentration of CO2.</p>					

494	KNX Channel X-{{...}}	VOC value	2byte	C,W, T,U	7.001 pulse 9.030 concentration(ug/m3) 9.008 parts/million(ppm)
<p>This communication object is visible when Ventilation system (with auto fan speed) is selected. The data type of the object is set by the parameter.</p> <p>The communication object is used to receive the input of the VOC value and get the corresponding value from the bus to be updated to the display in ppm. Range: 0~4000ppm</p> <p>If the control value of the automatic operation is VOC, the ventilation system can be set to automatically adjust the fan speed according to the concentration of VOC.</p>					
494	KNX Channel X-{{...}}	PM 2.5 value	2byte	C,W, T,U	7.001 pulse 9.030 concentration(ug/m3) 9.008 parts/million(ppm)
<p>This communication object is visible when Ventilation system (with auto fan speed) is selected. The data type of the object is set by the parameter.</p> <p>The communication object is used to receive the input of PM2.5 value and get the corresponding value from the bus to be updated to display in ug/m³. Range: 0~999ug/m³</p> <p>If the control value of the automatic operation is PM2.5, the ventilation system can be set to automatically adjust the fan speed according to the concentration of PM2.5.</p>					
496	KNX Channel X-{{...}}	Fan speed, status	1byte	C,W	5.001 percentage 5.100 fan stage
<p>The communication object is used to receive the status feedback of the fan speed. The specific telegram value corresponding to each fan speed is defined by the parameter.</p>					
497	KNX Channel X-{{...}}	Fan automatic operation,	1bit	C,W	1.003 enable

		status			
<p>This communication object is visible when Ventilation system (with auto fan speed) is selected.</p> <p>选择 Ventilation system(with auto fan speed).Used to receive status feedback from automatic fan speed control to the screen.</p>					
498	KNX Channel X-{{...}}	Heat recovery, status	1bit	C,W	1.003 enable
<p>The communication object is visible if the parameter "Heat recovery function" is enabled.Used to receive the status feedback of heat recovery, and is updated to screen display.</p>					
499	KNX Channel X-{{...}}	Filter timer reset	1bit	C,W	1.015 reset
<p>The communication object is visible if the parameter "Filter timer counter" is enabled.Used to reset the filter time, and after the filter is reset, the filter time is used to start counting again. Telegram value:</p> <p style="text-align: center;">1—Reset</p>					

Table 6.10.7"Ventilation system control"communication object

6.10.8 “Audio control” Communication object

Number ^	Name	Object Function	Description	Group Address	Length	C	R	W	T	U	Data Type	Priority
483	KNX Channel 1-...	Device online, status			1 bit	C	-	W	T	U	switch	Low
484	KNX Channel 1-...	Locking object			1 bit	C	-	W	-	-	enable	Low
486	KNX Channel 1-...	Play=1/Pause=0			1 bit	C	-	-	T	-	start/stop	Low
488	KNX Channel 1-...	Next track=1/Previous track=0			1 bit	C	-	-	T	-	step	Low
490	KNX Channel 1-...	Volume+=1/Volume-=0			1 bit	C	-	-	T	-	step	Low
491	KNX Channel 1-...	Mute			1 bit	C	-	-	T	-	enable	Low
493	KNX Channel 1-...	Absolute volume			1 byte	C	-	-	T	-	percentage (0..100%)	Low
495	KNX Channel 1-...	Play=1/Pause=0, status			1 bit	C	-	W	T	U	start/stop	Low
497	KNX Channel 1-...	Volume, status			1 byte	C	-	W	T	U	percentage (0..100%)	Low
498	KNX Channel 1-...	Mute, status			1 bit	C	-	W	T	U	enable	Low

Audio control

Number ^	Name	Object Function	Description	Group Address	Length	C	R	W	T	U	Data Type	Priority
483	KNX Channel 1-...	Device online, status			1 bit	C	-	W	T	U	switch	Low
484	KNX Channel 1-...	Locking object			1 bit	C	-	W	-	-	enable	Low
485	KNX Channel 1-...	Power on/off			1 bit	C	-	-	T	-	switch	Low
486	KNX Channel 1-...	Play=1/Pause=0			1 bit	C	-	-	T	-	start/stop	Low
488	KNX Channel 1-...	Next track=1/Previous track=0			1 bit	C	-	-	T	-	step	Low
490	KNX Channel 1-...	Volume+=1/Volume-=0			1 bit	C	-	-	T	-	step	Low
491	KNX Channel 1-...	Mute			1 bit	C	-	-	T	-	enable	Low
494	KNX Channel 1-...	Power on/off, status			1 bit	C	-	W	-	-	switch	Low
495	KNX Channel 1-...	Play=1/Pause=0, status			1 bit	C	-	W	T	U	start/stop	Low
498	KNX Channel 1-...	Mute, status			1 bit	C	-	W	T	U	enable	Low

Audio control(with on/off)

Number ^	Name	Object Function	Description	Group Address	Length	C	R	W	T	U	Data Type	Priority
483	KNX Channel 1-...	Device online, status			1 bit	C	-	W	T	U	switch	Low
484	KNX Channel 1-...	Locking object			1 bit	C	-	W	-	-	enable	Low
486	KNX Channel 1-...	Play			1 bit	C	-	-	T	-	enable	Low
487	KNX Channel 1-...	Pause			1 bit	C	-	-	T	-	enable	Low
488	KNX Channel 1-...	Next track			1 bit	C	-	-	T	-	enable	Low
489	KNX Channel 1-...	Previous track			1 bit	C	-	-	T	-	enable	Low
490	KNX Channel 1-...	Volume+=1/Volume-=0			1 bit	C	-	-	T	-	step	Low
491	KNX Channel 1-...	Mute			1 bit	C	-	-	T	-	enable	Low
493	KNX Channel 1-...	Play mode			1 byte	C	-	-	T	-	counter pulses (0..255)	Low
495	KNX Channel 1-...	Play, status			1 bit	C	-	W	T	U	enable	Low
496	KNX Channel 1-...	Pause, status			1 bit	C	-	W	T	U	enable	Low
498	KNX Channel 1-...	Mute, status			1 bit	C	-	W	T	U	enable	Low
499	KNX Channel 1-...	Play mode, status			1 byte	C	-	W	T	U	counter pulses (0..255)	Low

Audio control(play mode)

Number ^	Name	Object Function	Description	Group Address	Length	C	R	W	T	U	Data Type	Priority
483	KNX Channel 1-...	Device online, status			1 bit	C	-	W	T	U	switch	Low
484	KNX Channel 1-...	Locking object			1 bit	C	-	W	-	-	enable	Low
486	KNX Channel 1-...	Play			1 bit	C	-	-	T	-	enable	Low
487	KNX Channel 1-...	Pause			1 bit	C	-	-	T	-	enable	Low
488	KNX Channel 1-...	Next track			1 bit	C	-	-	T	-	enable	Low
489	KNX Channel 1-...	Previous track			1 bit	C	-	-	T	-	enable	Low
490	KNX Channel 1-...	Volume+=1/Volume-=0			1 bit	C	-	-	T	-	step	Low
491	KNX Channel 1-...	Mute			1 bit	C	-	-	T	-	enable	Low
493	KNX Channel 1-...	Absolute volume			1 byte	C	-	-	T	-	percentage (0..100%)	Low
495	KNX Channel 1-...	Play, status			1 bit	C	-	W	T	U	enable	Low
496	KNX Channel 1-...	Pause, status			1 bit	C	-	W	T	U	enable	Low
497	KNX Channel 1-...	Volume, status			1 byte	C	-	W	T	U	percentage (0..100%)	Low
498	KNX Channel 1-...	Mute, status			1 bit	C	-	W	T	U	enable	Low
500	KNX Channel 1-...	Track name			14 bytes	C	-	W	T	U	Character String (ISO 8...	Low
501	KNX Channel 1-...	Album name			14 bytes	C	-	W	T	U	Character String (ISO 8...	Low
502	KNX Channel 1-...	Artist name			14 bytes	C	-	W	T	U	Character String (ISO 8...	Low

Audio control(track information)

Number ^	Name	Object Function	Description	Group Address	Length	C	R	W	T	U	Data Type	Priority
483	KNX Channel 1-...	Device online, status			1 bit	C	-	W	T	U	switch	Low
484	KNX Channel 1-...	Locking object			1 bit	C	-	W	-	-	enable	Low
486	KNX Channel 1-...	Play			1 bit	C	-	-	T	-	enable	Low
487	KNX Channel 1-...	Pause			1 bit	C	-	-	T	-	enable	Low
488	KNX Channel 1-...	Next track			1 bit	C	-	-	T	-	enable	Low
489	KNX Channel 1-...	Previous track			1 bit	C	-	-	T	-	enable	Low
490	KNX Channel 1-...	Volume+=1/Volume-=0			1 bit	C	-	-	T	-	step	Low
491	KNX Channel 1-...	Mute			1 bit	C	-	-	T	-	enable	Low
492	KNX Channel 1-...	Next playlist=1/Previous playlist=0			1 bit	C	-	-	T	-	step	Low
493	KNX Channel 1-...	Absolute volume			1 byte	C	-	-	T	-	percentage (0..100%)	Low
495	KNX Channel 1-...	Play, status			1 bit	C	-	W	T	U	enable	Low
496	KNX Channel 1-...	Pause, status			1 bit	C	-	W	T	U	enable	Low
497	KNX Channel 1-...	Volume, status			1 byte	C	-	W	T	U	percentage (0..100%)	Low
498	KNX Channel 1-...	Mute, status			1 bit	C	-	W	T	U	enable	Low
500	KNX Channel 1-...	Track name			14 bytes	C	-	W	T	U	Character String (ISO 8...	Low
501	KNX Channel 1-...	Album name			14 bytes	C	-	W	T	U	Character String (ISO 8...	Low
502	KNX Channel 1-...	Artist name			14 bytes	C	-	W	T	U	Character String (ISO 8...	Low
503	KNX Channel 1-...	Playlist name			14 bytes	C	-	W	T	U	Character String (ISO 8...	Low

Audio control(track information+playlist)

Fig.6.10.8 "Audio control"communication object

NO.	Name	Object Function	Data Type	Flag	DPT
485	KNX Channel X-{{...}}	Power on/off	1bit	C,T	1.001 switch
<p>The communication object is visible when power on/off is enabled. Used to send the telegram to the bus. Telegrams:</p> <p style="text-align: center;">1—On</p> <p style="text-align: center;">0—Off</p>					
486	KNX Channel X-{{...}}	Play=1/Pause=0 Play	1bit	C,T	1.010 start/stop
<p>The communication object is visible when control play/pause with one object. Used to play/stop the music in the audio module. Telegrams:</p> <p style="text-align: center;">1—Play music</p> <p style="text-align: center;">0—Pause playing music</p>					
486	KNX Channel X-{{...}}	Play	1bit	C,T	1.003 enable
<p>The communication object is visible when control play/pause with two separate objects. Used to play the music in the audio module. Telegram :</p> <p style="text-align: center;">1—Play music</p>					
487	KNX Channel X-{{...}}	Pause	1bit	C,T	1.003 enable
<p>The communication object is visible when control play/pause with two separate objects. Used to stop the music in the audio module. Telegram:</p> <p style="text-align: center;">1—Pause playing music</p>					
488	KNX Channel X-{{...}}	Next track=1/Previous track=0	1bit	C,T	1.007 step
<p>The communication object is visible when control next track/previous track with one object. Used to switch the playing track of the audio module, to switch the previous track/the next track. Telegrams:</p> <p style="text-align: center;">1—Play the next track</p>					

0—Play the previous track					
488	KNX Channel X-{{...}}	Next track	1bit	C,T	1.003 enable
The communication object is visible when control next track/previous track with two separate objects. Used to switch the playing track of the audio module, to switch the next track. Telegram 1—switch the next track					
489	KNX Channel X-{{...}}	Previous track	1bit	C,T	1.003 enable
The communication object is visible when control next track/previous track with two separate objects. Used to switch the playing track of the audio module, to switch the previous track. Telegram: 1—switch the previous track					
490	KNX Channel X-{{...}}	Volume+=1/Volume-=0	1bit	C,T	1.007 step
When 1bit, the communication object is used to adjust volume of the audio module. Telegrams: 1—Increase volume 0—Decrease volume					
493	KNX Channel X-{{...}}	Absolute volume	1byte	C,T	5.001 percentage 5.004 percentage
When 1byte, the communication object is used to adjust volume of the audio module. Telegrams value is according to different object types: 0..100 / 0..255					
491	KNX Channel X-{{...}}	Mute	1bit	C,T	1.003 enable
The communication object is visible when mute is enabled. Used to control mute of audio module via the screen. Telegrams: 1—Mute 0—Cancel mute					
492	KNX Channel X-{{...}}	Next playlist=1/Previous playlist=0	1bit	C,T	1.007 step

<p>The communication object is visible when control next track/previous track with one object. Used to switch the playing list of the audio module. Telegrams:</p> <p style="padding-left: 40px;">1—Play the next list</p> <p style="padding-left: 40px;">0—Play the previous list</p>					
493	KNX Channel X-{{...}}	Play mode	1byte	C,T	5.010 counter pulses
<p>The communication object is used to send control telegram of the audio module play mode, different mode telegrams are preset by parameters.</p>					
494	KNX Channel X-{{...}}	Power on/off, status	1bit	C,W, T,U	1.001 switch
<p>The communication object is visible when power on/off is enabled. Used to receive the status feedback of on/off in audio module from bus.</p>					
495	KNX Channel X-{{...}}	Play=1/Pause=0, status	1bit	C,W, T,U	1.010 start/stop
<p>The communication object is used to receive the status feedback of play/pause in audio module from bus, and feed back to screen display.</p>					
495	KNX Channel X-{{...}}	Play, status	1bit	C,W, T,U	1.003 enable
<p>The communication object is visible when control play/pause with two separate objects. Used to receive the status feedback of play in audio module from bus, and feed back to screen display. Telegrams:</p> <p style="padding-left: 40px;">1—Play music</p>					
496	KNX Channel X-{{...}}	Pause, status	1bit	C,W, T,U	1.003 enable
<p>The communication object is visible when control play/pause with two separate objects. Used to receive the status feedback of pause in audio module from bus, and feed back to screen</p>					

display.Telegrams:					
1—Pause music					
497	KNX Channel X-{{...}}	Volume, status	1byte	C,W, T,U	5.001 percentage 5.004 percentage
<p>When 1byte, the communication object is used to receive the volume status in audio module, and feed back to screen display.</p> <p>Telegrams value is according to different object types: 0..100 / 0..255</p>					
498	KNX Channel X-{{...}}	Mute, status	1bit	C,W, T,U	1.003 enable
<p>The communication object is visible when mute is enabled. Used to receive the mute status of the audio module from the bus, and feed back to screen display.</p>					
499	KNX Channel X-{{...}}	Play mode, status	1byte	C,W, T,U	5.010 counter pulses
<p>The communication object is used to receive the status feedback of play mode in the audio module, the receiving telegrams should be preset by parameters before the display status on the screen can be updated.</p>					
500	KNX Channel X-{{...}}	Track name	14byte	C,W, T,U	16.001 character string (ISO 8859-1)
<p>The communication object is used to receive the track name via the bus, and display on the screen.</p>					
501	KNX Channel X-{{...}}	Album name	14byte	C,W, T,U	16.001 character string (ISO 8859-1)
<p>The communication object is used to receive the album name via the bus, and display on the screen.</p>					
502	KNX Channel X-{{...}}	Artist name	14byte	C,W, T,U	16.001 character string (ISO 8859-1)

The communication object is used to receive the artist name via the bus, and display on the screen.					
503	KNX Channel X-{{...}}	Playlist name	14byte	C,W, T,U	16.001 character string (ISO 8859-1)
The communication object is used to receive the playlist name via the bus, and display on the screen.					

Table 10.6.8 "Audio control" communication object

6.10.9 “Energy metering value display”Communication object

Number ^	Name	Object Function	Description	Group Address	Length	C	R	W	T	U	Data Type	Priority
483	KNX Channel 1-...	Device online, status			1 bit	C	-	W	T	U	switch	Low
487	KNX Channel 1-...	Power value			2 bytes	C	-	W	T	U	power (kW)	Low
488	KNX Channel 1-...	Energy value			4 bytes	C	-	W	T	U	active energy (kWh)	Low

Energy metering(power & energy)

Number ^	Name	Object Function	Description	Group Address	Length	C	R	W	T	U	Data Type	Priority
483	KNX Channel 1-...	Device online, status			1 bit	C	-	W	T	U	switch	Low
485	KNX Channel 1-...	Current value			2 bytes	C	-	W	T	U	current (mA)	Low
487	KNX Channel 1-...	Power value			2 bytes	C	-	W	T	U	power (kW)	Low
488	KNX Channel 1-...	Energy value			4 bytes	C	-	W	T	U	active energy (kWh)	Low

Energy metering(power & energy & current)

Number ^	Name	Object Function	Description	Group Address	Length	C	R	W	T	U	Data Type	Priority
483	KNX Channel 1-...	Device online, status			1 bit	C	-	W	T	U	switch	Low
485	KNX Channel 1-...	Current value			2 bytes	C	-	W	T	U	current (mA)	Low
486	KNX Channel 1-...	Voltage value			4 bytes	C	-	W	T	U	electric potential (V)	Low
487	KNX Channel 1-...	Power value			2 bytes	C	-	W	T	U	power (kW)	Low
488	KNX Channel 1-...	Energy value			4 bytes	C	-	W	T	U	active energy (kWh)	Low

Energy metering(power & energy & current & voltage)

Fig.6.10.9 “Energy metering value display”communication object

NO.	Name	Object Function	Data Type	Flag	DPT
485	KNX Channel X-{{...}}	Current value	2byte	C,W,T,U	7.012 current(mA)
<p>The communication object is used to receive the current value from the bus and update it to the screen display.</p> <p>The display range is 0 ~ 65535 mA, and the resolution is 1 mA.</p>					
485	KNX Channel X-{{...}}	Current value	2byte	C,W,T,U	9.021 current(mA)
<p>The communication object is used to receive the current value from the bus and update it to the screen display.</p> <p>The display range is -670760~670760mA, and the resolution is 0.01mA.</p>					
485	KNX Channel X-{{...}}	Current value	4byte	C,W,T,U	14.019 electric current(A)
<p>The communication object is used to receive the current value from the bus and update it to the screen display.</p>					

The display range is -99999999.9~99999999.9A, and the resolution is 0.1A.					
486	KNX Channel X-{{...}}	Voltage value	2byte	C,W,T,U	9.020 voltage(mV)
<p>The communication object is used to receive voltage values from the bus and update them to the screen display.</p> <p>The display range is -670760mV~670760mV, and the resolution is 0.1mV.</p>					
486	KNX Channel X-{{...}}	Voltage value	4byte	C,W,T,U	14.027 electric potential(V)
<p>The communication object is used to receive voltage values from the bus and update them to the screen display.</p> <p>The display range is: -99999999.9~99999999.9V, and the resolution is 0.1V.</p>					
487	KNX Channel X-{{...}}	Power value	2byte	C,W,T,U	9.024 power(kW)
<p>The communication object is used to receive the power values from the bus and update them to the screen display.</p> <p>The display range is: -670760~670760kW, and the resolution is 0.01kW.</p>					
487	KNX Channel X-{{...}}	Power value	4byte	C,W,T,U	14.056 power(W)
<p>The communication object is used to receive the power values from the bus and update them to the screen display.</p> <p>The display range is: -99999999.9 ~ 99999999.9W, and the resolution is 0.1W.</p>					
488	KNX Channel X-{{...}}	Energy value	4byte	C,W,T,U	13.010 active energy(Wh)
<p>The communication object is used to receive the electrical values from the bus and update them to the screen display.</p> <p>The display range is: -2147483648~2147483647Wh, and the resolution is 1Wh.</p>					
488	KNX Channel X-{{...}}	Energy value	4byte	C,W,T,U	13.013 active energy(kWh)
<p>The communication object is used to receive the electrical values from the bus and update them to the screen display.</p> <p>The display range is: -2147483648~2147483647kWh, and the resolution is 1kWh.</p>					

Table 10.6.9 “Energy metering value display” communication object

6.10.10 "Sensor" Communication object

Number ^	Name	Object Function	Description	Group Address	Length	C	R	W	T	U	Data Type	Priority
483	KNX Channel 1-...	Device online, status			1 bit	C	-	W	T	U	switch	Low
485	KNX Channel 1-...	Temperature value			2 bytes	C	-	W	T	U	temperature (°C)	Low
486	KNX Channel 1-...	Low temperature alarm			1 bit	C	R	-	T	-	alarm	Low
487	KNX Channel 1-...	High temperature alarm			1 bit	C	R	-	T	-	alarm	Low

Temperature sensor

Number ^	Name	Object Function	Description	Group Address	Length	C	R	W	T	U	Data Type	Priority
483	KNX Channel 1-...	Device online, status			1 bit	C	-	W	T	U	switch	Low
485	KNX Channel 1-...	Humidity value			2 bytes	C	-	W	T	U	humidity (%)	Low
486	KNX Channel 1-...	Low humidity alarm			1 bit	C	R	-	T	-	alarm	Low
487	KNX Channel 1-...	High humidity alarm			1 bit	C	R	-	T	-	alarm	Low

Humidity sensor

Number ^	Name	Object Function	Description	Group Address	Length	C	R	W	T	U	Data Type	Priority
483	KNX Channel 1-...	Device online, status			1 bit	C	-	W	T	U	switch	Low
485	KNX Channel 1-...	PM2.5 value			2 bytes	C	-	W	T	U	pulses	Low
486	KNX Channel 1-...	PM2.5 alarm			1 bit	C	R	-	T	-	alarm	Low

PM2.5 sensor

Number ^	Name	Object Function	Description	Group Address	Length	C	R	W	T	U	Data Type	Priority
483	KNX Channel 1-...	Device online, status			1 bit	C	-	W	T	U	switch	Low
485	KNX Channel 1-...	PM10 value			2 bytes	C	-	W	T	U	pulses	Low
486	KNX Channel 1-...	PM10 alarm			1 bit	C	R	-	T	-	alarm	Low

PM10 sensor

Number ^	Name	Object Function	Description	Group Address	Length	C	R	W	T	U	Data Type	Priority
483	KNX Channel 1-...	Device online, status			1 bit	C	-	W	T	U	switch	Low
485	KNX Channel 1-...	VOC value			2 bytes	C	-	W	T	U	pulses	Low
486	KNX Channel 1-...	VOC alarm			1 bit	C	R	-	T	-	alarm	Low

VOC sensor

Number ^	Name	Object Function	Description	Group Address	Length	C	R	W	T	U	Data Type	Priority
483	KNX Channel 1-...	Device online, status			1 bit	C	-	W	T	U	switch	Low
485	KNX Channel 1-...	AQI value			2 bytes	C	-	W	T	U	pulses	Low
486	KNX Channel 1-...	AQI alarm			1 bit	C	R	-	T	-	alarm	Low

AQI sensor

Number ^	Name	Object Function	Description	Group Address	Length	C	R	W	T	U	Data Type	Priority
483	KNX Channel 1-...	Device online, status			1 bit	C	-	W	T	U	switch	Low
485	KNX Channel 1-...	CO2 value			2 bytes	C	-	W	T	U	parts/million (ppm)	Low
486	KNX Channel 1-...	CO2 alarm			1 bit	C	R	-	T	-	alarm	Low

CO2 sensor

Number ^	Name	Object Function	Description	Group Address	Length	C	R	W	T	U	Data Type	Priority
483	KNX Channel 1-...	Device online, status			1 bit	C	-	W	T	U	switch	Low
485	KNX Channel 1-...	Brightness value(lux)			2 bytes	C	-	W	T	U	lux (Lux)	Low

Brightness sensor

Number ^	Name	Object Function	Description	Group Address	Length	C	R	W	T	U	Data Type	Priority
483	KNX Channel 1-...	Device online, status			1 bit	C	-	W	T	U	switch	Low
485	KNX Channel 1-...	Wind speed			2 bytes	C	-	W	T	U	speed (m/s)	Low
486	KNX Channel 1-...	Wind alarm			1 bit	C	R	-	T	-	alarm	Low

Wind sensor

Number ^	Name	Object Function	Description	Group Address	Length	C	R	W	T	U	Data Type	Priority
483	KNX Channel 1-...	Device online, status			1 bit	C	-	W	T	U	switch	Low
485	KNX Channel 1-...	I/O signal			1 bit	C	-	W	T	U	switch	Low

I/O sensor

Fig.6.10.10 "Sensor" communication object

NO.	Name	Object Function	Data Type	Flag	DPT
485	KNX Channel X-{{...}}	Temperature value	2byte	C,W,T,U	9.001 temperature
485	KNX Channel X-{{...}}	Humidity value	2byte	C,W,T,U	9.007 humidity
485	KNX Channel X-{{...}}	PM2.5 value	2byte	C,W,T,U	7.001 pulse 9.030 concentration(ug/m3)
485	KNX Channel X-{{...}}	PM10 value	2byte	C,W,T,U	7.001 pulse 9.030 concentration(ug/m3)
485	KNX Channel X-{{...}}	VOC value	2byte	C,W,T,U	7.001 pulse 9.030 concentration(ug/m3)
485	KNX Channel X-{{...}}	AQI value	2byte	C,W,T,U	7.001 pulses
485	KNX Channel X-{{...}}	CO2 value	2byte	C,W,T,U	7.001 pulse 9.008 parts/million(ppm)
485	KNX Channel X-{{...}}	Brightness value(lux)	2byte	C,W,T,U	7.013 brightness(lux) 9.004 lux(lux)
485	KNX Channel X-{{...}}	Wind speed	2byte	C,W,T,U	9.005 speed

					9.028 wind speed
485	KNX Channel X-{{...}}	I/O signal	1bit	C,W,T,U	1.001 switch
<p>These communication objects are used to receive air quality information from the bus and update it to the on-screen display. The screen can display settings for temperature, humidity, PM2.5, PM10, VOC, AQI, CO2, brightness, wind speed and I/O signal values.</p> <p>The data type of the object is set by the parameter. All objects send read requests to the bus on restart.</p>					
486	KNX Channel X-{{...}}	Low temperature alarm	1bit	C,R,T	1.005 alarm
<p>The communication object is used for the low temperature alarm object to send an alarm signal to the bus when the temperature falls below a low threshold. The threshold value is defined by the parameter. Telegrams:</p> <p style="text-align: center;">1—Low temperature alarm</p> <p style="text-align: center;">0—No alarm</p>					
487	KNX Channel X-{{...}}	High temperature alarm	1bit	C,R,T	1.005 alarm
<p>This communication object is used for the high temperature alarm object to send an alarm signal to the bus when the temperature g is above a threshold value. The threshold value is defined by the parameter. Telegrams:</p> <p style="text-align: center;">1—High temperature alarm</p> <p style="text-align: center;">0—No alarm</p>					
486	KNX Channel X-{{...}}	Low humidity alarm	1bit	C,R,T	1.005 alarm
<p>This communication object is used for the low humidity alarm object to send an alarm signal to the bus when the humidity falls below a threshold value. The threshold value is defined by the parameter.</p> <p>Telegrams: 1—Low humidity</p>					

0--No alarm					
487	KNX Channel X-{{...}}	High humidity alarm	1bit	C,R,T	1.005 alarm
<p>This communication object is used for the high humidity alarm object to send an alarm signal to the bus when the humidity is above a threshold value. The threshold value is defined by the parameter.</p> <p>Telegrams: 1--High humidity</p> <p style="padding-left: 100px;">0--No alarm</p>					
486	KNX Channel X-{{...}}	PM2.5 alarm	1bit	C,R,T	1.005 alarm
486	KNX Channel X-{{...}}	PM10 alarm	1bit	C,R,T	1.005 alarm
486	KNX Channel X-{{...}}	AQI alarm	1bit	C,R,T	1.005 alarm
486	KNX Channel X-{{...}}	CO2 alarm	1bit	C,R,T	1.005 alarm
486	KNX Channel X-{{...}}	VOC alarm	1bit	C,R,T	1.005 alarm
486	KNX Channel X-{{...}}	Wind alarm	1bit	C,R,T	1.005 alarm
<p>These communication objects are used when PM2.5/PM10/AQI/CO2/VOC/Wind exceeds the alarm value, and the PM2.5/PM10/AQI/CO2/VOC/Wind alarm object sends an alarm signal to the bus. Telegrams:</p> <p style="padding-left: 100px;">1--Alarm</p> <p style="padding-left: 100px;">0--No alarm</p>					

Table 6.10.10 "Sensor"communication object

6.10.11 "Value sender" Communication object

Number ^	Name	Object Function	Description	Group Address	Length	C	R	W	T	U	Data Type	Priority
484	KNX Channel 1-...	Locking object			1 bit	C	-	W	-	-	enable	Low
485	KNX Channel 1-...	Send 1bit value			1 bit	C	-	W	T	-	switch	Low
487	KNX Channel 1-...	Send 1bit value, long			1 bit	C	-	W	T	-	switch	Low

1bit value[ON/OFF]

Number ^	Name	Object Function	Description	Group Address	Length	C	R	W	T	U	Data Type	Priority
484	KNX Channel 1-...	Locking object			1 bit	C	-	W	-	-	enable	Low
485	KNX Channel 1-...	Send 2bit value			2 bit	C	-	W	T	-	switch control	Low
487	KNX Channel 1-...	Send 2bit value, long			2 bit	C	-	W	T	-	switch control	Low

2bit value[0...3]

Number ^	Name	Object Function	Description	Group Address	Length	C	R	W	T	U	Data Type	Priority
484	KNX Channel 1-...	Locking object			1 bit	C	-	W	-	-	enable	Low
485	KNX Channel 1-...	Send 4bit value			4 bit	C	-	W	T	-	dimming control	Low
487	KNX Channel 1-...	Send 4bit value, long			4 bit	C	-	W	T	-	dimming control	Low

4bit value[0...15]

Number ^	Name	Object Function	Description	Group Address	Length	C	R	W	T	U	Data Type	Priority
484	KNX Channel 1-...	Locking object			1 bit	C	-	W	-	-	enable	Low
485	KNX Channel 1-...	Send 1byte value			1 byte	C	-	W	T	-	counter pulses (0..255)	Low
487	KNX Channel 1-...	Send 1byte value, long			1 byte	C	-	W	T	-	counter pulses (0..255)	Low

1byte value[0...255]

Number ^	Name	Object Function	Description	Group Address	Length	C	R	W	T	U	Data Type	Priority
484	KNX Channel 1-...	Locking object			1 bit	C	-	W	-	-	enable	Low
485	KNX Channel 1-...	Send 2byte value			2 bytes	C	-	W	T	-	pulses	Low
487	KNX Channel 1-...	Send 2byte value, long			2 bytes	C	-	W	T	-	pulses	Low

2byte value[0...65535]

Number ^	Name	Object Function	Description	Group Address	Length	C	R	W	T	U	Data Type	Priority
484	KNX Channel 1-...	Locking object			1 bit	C	-	W	-	-	enable	Low
485	KNX Channel 1-...	Send 2byte float value			2 bytes	C	-	W	T	-	2-byte float value	Low
487	KNX Channel 1-...	Send 2byte float value, long			2 bytes	C	-	W	T	-	2-byte float value	Low

2byte float value

Number ^	Name	Object Function	Description	Group Address	Length	C	R	W	T	U	Data Type	Priority
484	KNX Channel 1-...	Locking object			1 bit	C	-	W	-	-	enable	Low
485	KNX Channel 1-...	Send 4byte value			4 bytes	C	-	W	T	-	counter pulses (unsign...)	Low
487	KNX Channel 1-...	Send 4byte value, long			4 bytes	C	-	W	T	-	counter pulses (unsign...)	Low

4byte value[0...4294967295]

Number ^	Name	Object Function	Description	Group Address	Length	C	R	W	T	U	Data Type	Priority
484	KNX Channel 1-...	Locking object			1 bit	C	-	W	-	-	enable	Low
485	KNX Channel 1-...	Send 4byte float value			4 bytes	C	-	W	T	-	4-byte float value	Low
487	KNX Channel 1-...	Send 4byte float value, long			4 bytes	C	-	W	T	-	4-byte float value	Low

4byte float value

Fig.6.10.11 "Value sender" communication object

NO.	Name	Object Function	Data Type	Flag	DPT
485	KNX Channel X-{{...}}	Send 1bit value	1bit	C,T,W	1.001 switch
485	KNX Channel X-{{...}}	Send 2bit value	2bit	C,T,W	2.001 switch control
485	KNX Channel X-{{...}}	Send 4bit value	4bit	C,T,W	3.007 dimming
485	KNX Channel X-{{...}}	Send 1byte value	1byte	C,T,W	5.010 counter pulses
485	KNX Channel X-{{...}}	Send 2byte value	2byte	C,T,W	7.001 pulses
485	KNX Channel X-{{...}}	Send 2byte float value	2byte	C,T,W	9.x float value
485	KNX Channel X-{{...}}	Send 4byte value	4byte	C,T,W	12.001 counter pulses
485	KNX Channel X-{{...}}	Send 4byte float value	4byte	C,T,W	14.x float value
<p>The communication object is used to send the preset output value of the parameter, and if the long press.</p> <p>operation is distinguished from the short press operation, only the output value of the short press operation is sent. The object type and value range are determined by the data type set by the parameter.</p>					
487	KNX Channel X-{{...}}	Send 1bit value, long	1bit	C,T,W	1.001 switch
487	KNX Channel X-{{...}}	Send 2bit value, long	2bit	C,T,W	2.001 switch control
487	KNX Channel X-{{...}}	Send 4bit value, long	4bit	C,T,W	3.007 dimming
487	KNX Channel X-{{...}}	Send 1byte value, long	1byte	C,T,W	5.010 counter pulses
487	KNX Channel X-{{...}}	Send 2byte value, long	2byte	C,T,W	7.001 pulses
487	KNX Channel X-{{...}}	Send 2byte float value, long	2byte	C,T,W	9.x float value
487	KNX Channel X-{{...}}	Send 4byte value, long	4byte	C,T,W	12.001 counter pulses
487	KNX Channel X-{{...}}	Send 4byte float value, long	4byte	C,T,W	14.x float value
<p>The communication object is visible when the long press operation is distinguished from the short press operation, used to send the output value when long operation.</p>					

Table 6.10.11 "Value sender" communication object

6.11 “KNX Scene” Communication object

Number ^	Name	Object Function	Description	Group Address	Length	C	R	W	T	U	Data Type	Priority
3003	Scene 1-...	Scene			1 byte	C	-	W	T	-	scene control	Low

Fig.6.11 “KNX Scene”communication object

NO.	Name	Object Function	Data Type	Flag	DPT
3003/.../3032	Scene X-{{...}}	Scene control	1byte	C,T,W	18.001 scene control
<p>The communication object is visible when scene function enabled. Used to recall/storage scene via bus.</p>					

表 6.11 “KNX Scene”communication object

6.12 “Extension function” Communication object

3033	Extension function	Screen locking	1 bit	C	-	W	-	-	enable	低
3034	Extension function	Screen on/off	1 bit	C	-	W	-	-	switch	低
3035	Extension function	Wake-up screen trigger, scene NO.	1 byte	C	-	-	T	-	scene number	低
3038	Extension function	Night mode	1 bit	C	R	-	T	-	day/night	低
3039	Extension function	Summer time status	1 bit	C	-	-	T	-	enable	低
3040	Extension function	Dis/En Proximity function	1 bit	C	-	W	-	-	enable	低
3041	Extension function	Proximity input	1 bit	C	-	W	-	-	switch	低
3042	Extension function	Proximity output	1 bit	C	-	-	T	-	switch	低

Fig.6.12 “Extension function, Screensaver”communication object

NO.	Name	Object Function	Data Type	Flag	DPT
3033	Extension function	Screen locking	1bit	C,W	1.003 enable
<p>The communication object is used to lock the screen. After screen locked, the operation on the screen will not be responded, but can still receive the bus telegram. Telegrams:</p> <p>0 --- Lock</p> <p>1 --- Unlock</p>					
3034	Extension function	Screen on/off	1bit	C,W	1.001 switch
<p>The communication object is used to control the screen on/off. Telegrams:</p> <p>0 --- OFF</p> <p>1 --- ON</p>					
3035	Extension function	Wake-up screen trigger, 1bit value/1byte value/scene NO.	1bit 1byte	C,T	1.001 switch 5.010 counter pulses 5.001 percentage 17.001 scene number
<p>The communication objects are visible when wake-up password function is enabled and output value is selected. The range of value is determined by the selected data type.</p>					
3038	Extension function	Night mode	1bit	C,R,T	1.024 day/night

				C,W,T ,U	
<p>The communication object is used to send day/night status to the bus. The telegram is defined by the parameter. Telegram :</p> <p>The object flag is C,W,T,U when the day/night status is switched according to the object, receive the telegram value via bus to switch;</p> <p>The object flag is C,R,T when the day/night status is switched according to the time point or sunrise and sunset time, can not receive the telegram value via bus to switch.</p>					
3039	Extension function	Summer time status	1bit	C,T	1.003 enable
<p>The communication object is used to send the status telegrams of the summer time to the bus. Telegrams:</p> <p style="padding-left: 40px;">1 — Summer time enable</p> <p style="padding-left: 40px;">0 — Summer time disable</p>					
3040	Extension function	Dis/En Proximity function	1bit	C,W	1.003 enable
<p>The communication object is used to enable/disable proximity function.</p>					
3041	Extension function	Proximity input	1bit	C,W	1.001 switch
<p>The communication object is visible when proximity function is triggered by the object. Receive the telegram value from bus:</p> <p style="padding-left: 40px;">1—Trigger proximity function</p> <p style="padding-left: 40px;">0—Leaving (No proximity)</p>					
3042	Extension function	Proximity output	1bit	C,T	1.001 switch

			1byte		5.010 counter pulses 17.001 scene number 5.001 percentage
<p>The communication object is determined by the parameter "Object type of output value".</p> <p>When a person is detected approaching the sensing area, the object can send a specified value (1 byte) or ON (1 bit) to the bus.</p> <p>The range of values is determined by the selected data type.</p>					

Table 6.12 "Extension function, Screensaver" communication object