

User Manual

Indoor Station



**H Series Digital System Indoor Monitor
User Manual_V1.1
H-IS07S**

Attentions

1、 Please keep devices away from strong magnetic field , high temperature , wet environment ;



2、 Please do not fall the devices to the ground or make them get hard impact ;



3、 Please do not use wet cloth or volatile reagent to wipe the devices ;



4、 Please do not disassemble the devices.

Content

Chapter 1 Function Review	1
Chapter 2 Product Introduction	2
2.1 Product Appearance	2
2.2 Product Dimension	3
2.3 Parameters	3
2.4 Interface Description	4
Chapter 3 Basic Function	5
3.1 Standby Interface	5
3.2 Call in	6
3.3 Information	7
3.4 Call	8
3.5 Surveillance	9
3.6 Alarm System Setting	11
3.7 Arm for presence/Leaving	12
Chapter 4 System Setting	13
4.1 Time Setting	13
4.2 Camera Setting	13
4.3 Call Divert Setting	14
4.4 Password Setting	14
4.5 Ringtone Setting	15
4.6 Display Setting	17
4.7 Language Setting	17
4.8 Configuration Setting	18
4.9 Screen Clean	19
Chapter 5 Smart Home	20
5.1 Scene	20
5.2 Light	20
5.3 AC	21
5.4 Floor Heating	21
5.5 Fresh Air	22
5.6 Switch	22
5.7 Curtain	22
5.8 Water Heater	23

5.9 Music	23
Chapter 6 Installation	24
6.1 Height Installation	24
6.2 Installation Illustration	25
Chapter 7 Defense Area Wiring	26
7.1 Defense Area Wiring Diagram	26
7.2 Defense area attribute description	27
7.3 Doorbell Function	27

Chapter 1 Function Review

This product, based on TCP/IP transmission protocol, is the main device for the H series video door phone system, it supports video phone, defense area setting and picture tweeting. Details of the device are as follows:

- **7" capacitive touch screen**
- **H-IS07S support 48V standard PoE power supply**
- **Support connection to doorbell and villa outdoor monitor**
- **Support extendable elevator-reserve service**
- **Support real time surveillance to outdoor/mini outdoor station, IP camera**
- **Support message receiving and sending from guard unit**
- **Support multi-indoor-monitor in apartment, synchronizing arm/disarm**
- **Support video phone between residents and visitors/guard unit**
- **Support intercom function between residents in the same community**
- **Support standard 7 defense areas alarm function**

Chapter 2 Product Introduction

2.1 Product Appearance

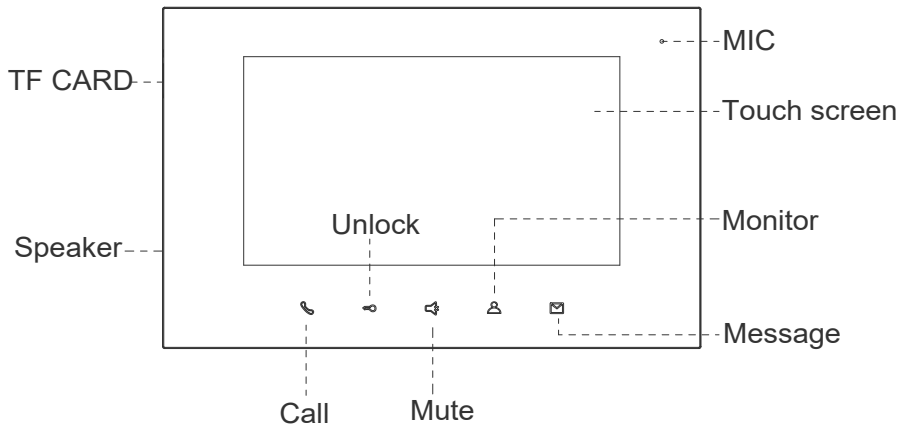
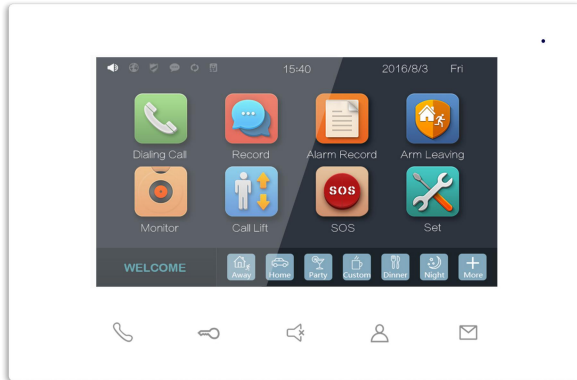

2.2 Product Dimension

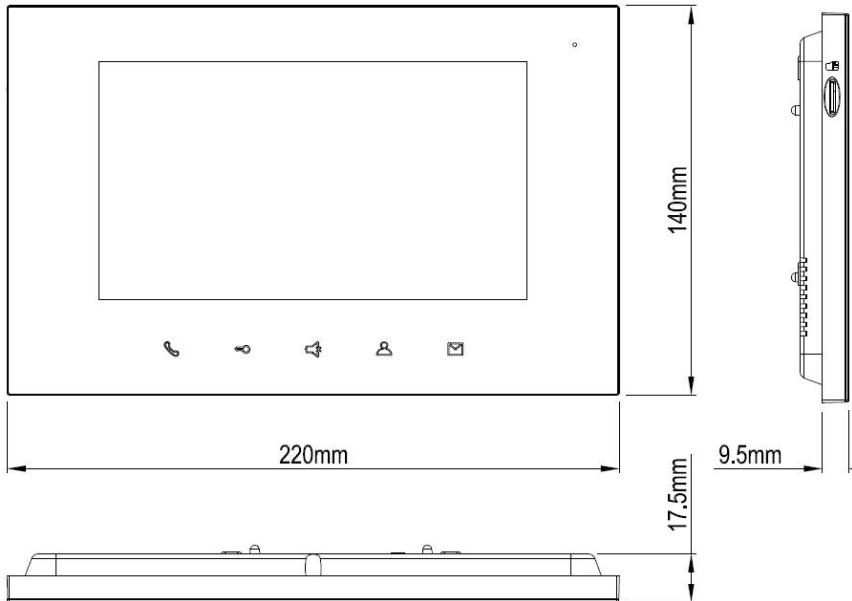

2.3 Parameters

Working Voltage: DC 24V

Quiescent Current: ≤ 80 mA

Working Current: ≤ 200 mA

LCD Display: 7 inch

Resolution: 800×480

Outline Dimension (L \times W \times D): $220 \times 140 \times 17.5$ mm

Working Temperature : $-10^{\circ}\text{C} \sim +55^{\circ}\text{C}$

Ring duration: 30 S Call duration: 120 S Monitor duration: 30 S

2.4 Interface Description

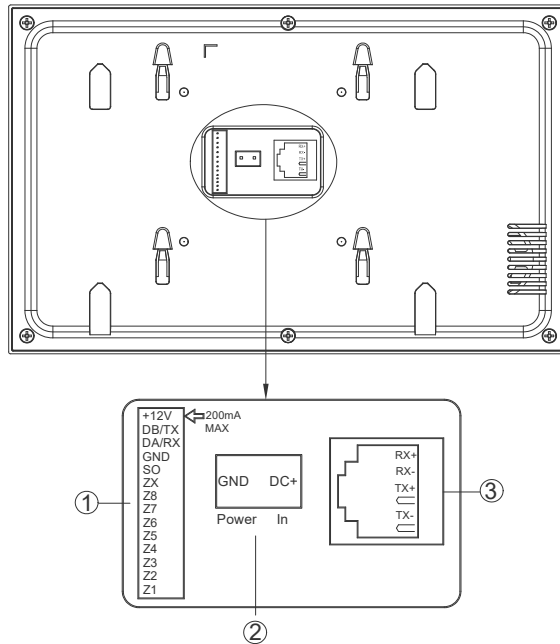

Number ①:

+12V、GND: Defense area interface(current output \leq 200mA).

DA/RX、DB/TX: (extension for defense zone and smart home function).

SO: alarm output interface.

Z8: Default doorbell.

Z7 to Z1: Standard interface for defense area, support normally-open / normally-close security module.

ZX: reserved interface.

Number ②:

Power input interface: DC 24 V.

Number ③:

H-IS07S Internet interface(Standard 48V PoE power supply).

Chapter 3 Basic Function

3.1 Standby Interface



Dialing Call

Click  ,entering the interface of intercom page, able to call management center、 other residents、 in-house other extensions.

Record

Click  ,to check notice from community, and to browse or delete the call log.

Alarm Record

Click  ,to check the alarm record, and set up every defense area.

Arm Leaving

Click  ,to input user password to perform the function of arming/ disarm defense area .

Monitor

Click  ,to monitor the outdoor station、 mini outdoor station、 gaate station and IP camera.

Call Lift

Click  , to call the elevator to the tenement floor.

SOS

Long press  for above 2 seconds, able to send SOS to management center.

Set

Click  , entering the interface of setting.

Scene Mode

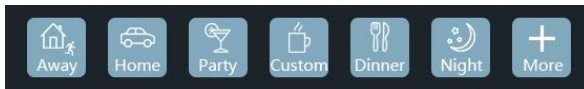

Support KNX devices to realize smart home scene mode setting.

3.2 Call in



Interface of Bell Rings

Basic workflow: Ring bell \Rightarrow Talk \Rightarrow Unlock \Rightarrow Call ended

Incoming Call:





- 1) Visitor can call indoor monitor through outdoor station, the bell of indoor monitor rings.
- 2) Resident Press  to answer the call.
- 3) During the call, resident can Press  to unlock the gate/door, 5s after unlock the call will be ended automatically.
- 4) Resident can press button  to end up the talking.

Image Capture:

- 1) During the call, resident can Press  to capture images.
- 2) The snapshot will be saved and can be browsed in the message records.



Snapshot

3.3 Information

Press  to enter information page to check messages received from guard unit.

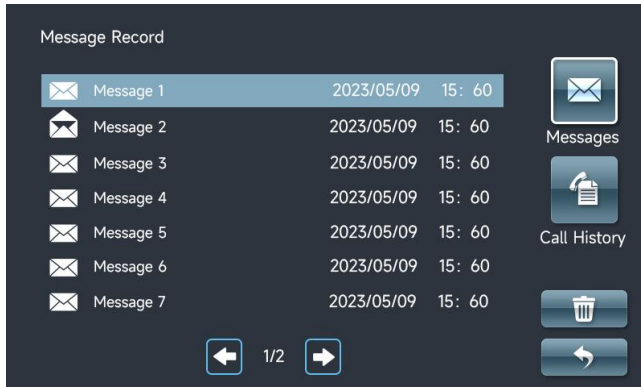

Interface of Message Browsed

Browse Message

Selecting one message and open it, the detailed information will be come out and it also can be deleted at this page.

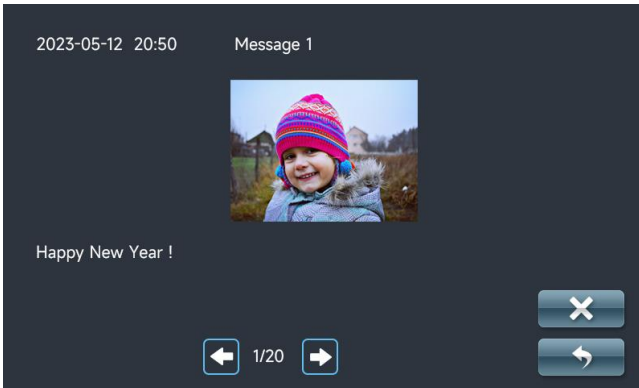

Interface of Detail Message

3.4 Call

Press  in stand-by page to enter calling page.

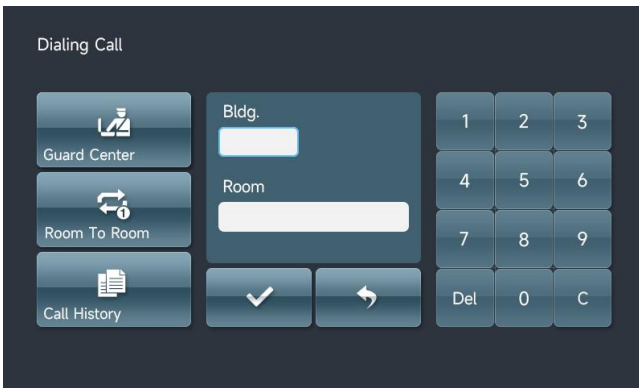



Calling Page with dial pads

Call Indoor Station

Basic workflow: Call ⇔ Bell rings ⇔ Talk ⇔ Intercom Completed

1) Call

Click  showing a list of indoor stations, to call other indoor stations of this house, or broadcast;

When call other residents, input the building number and room number, press  to confirm to call; If input room number only, the building number will be default as 0 by system.



- 2) The monitor will have ring back tone.
- 3) After answering by the called tenement, talk begins.
- 4) Press  to complete talking.

NOTE:

1. when talking to residents in the same unit, elevator can be reserved in pop-up.
2. during calling residents can choose to answer when there's a new call comes in.

Call Guard Unit

Steps: Call \rightleftarrows Talk \rightleftarrows Talk completed

- 1) Press  to call the management center.
- 2) Guard unit bell rings.
- 3) Talk with guard unit.
- 4) Resident press  to complete talking.

3.5 Surveillance



Monitoring page

The surveillance includes monitoring outdoor monitor, villa outdoor monitor, wall monitor and IP cameras.

Monitor and Unlock

**Basic workflow : choose monitoring facility ⇒ Monitoring ⇒ Unlock
⇒Monitoring completed**



- 1) Click  in the menu, choose monitoring facility.
- 2) Start monitoring.
- 3) During monitoring, tenement press  to open door for visitors.
- 4) Click , complete monitoring.

Image Capture in Surveillance

During surveillance, press  to capture images.

Notice: Snapshot photos will be saved in the call log.

Visitors Call In

Basic workflow: Monitor ⇒ **Talk** ⇒ **End up talking**

During monitor (mini outdoor station, outdoor station, gate station), resident press  to talk with visitors.

Community Surveillance

Press , to choose IP camera to start community monitoring.

3.6 Alarm System Setting

Press  in the menu, entering in the interface of alarm system.

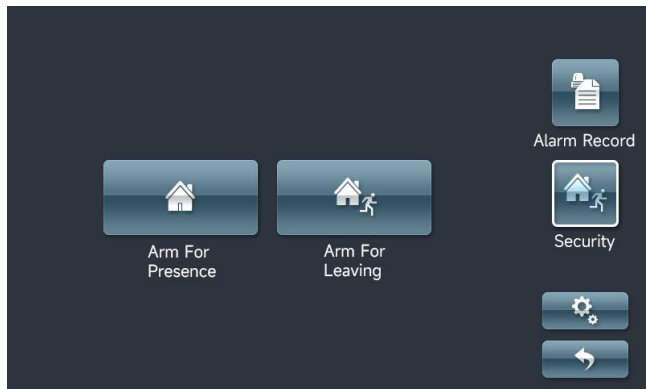

Interface of Alarm System

Click  to input user password to enter the interface of defense setting.
(Default user password: 666666)

NOTE:

1. under disarming, the page shows disarm icon to ensure the user to disarm when needed.
2. under arming, when user is threatened, he can input hijack password to disarm, a hijack message will be sent to guard unit to cause attention (hijack password needs to be set).

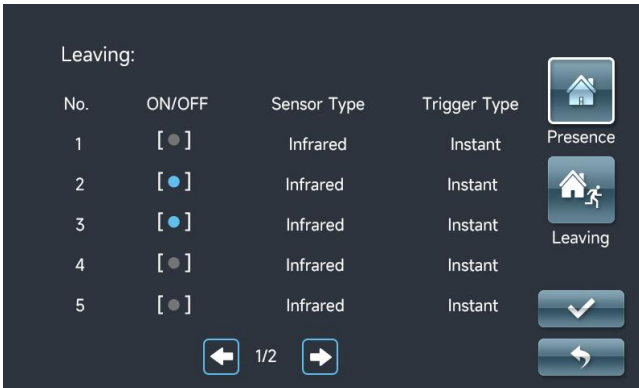

Interface of Defense Setting

Alarm System Setting

In the page of alarm system setting, residents can switch on/off each defense area, choose defense area type and trigger conditions, relevant defense areas types and trigger conditions please refer to Defense Area Wiring.

3.7 Arm for presence/Leaving

Press  to arm/disarm home.

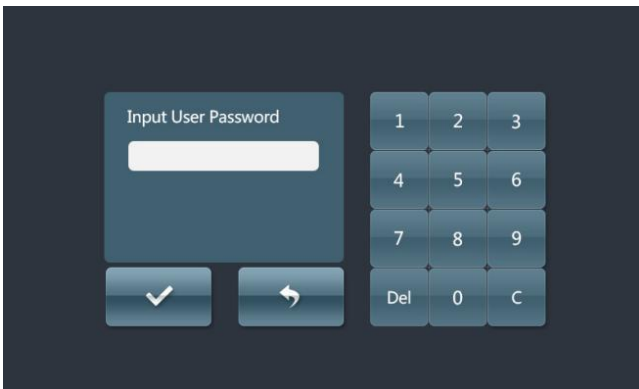

Interface of Password Input and Confirm

Under arming, the user can:

Disarm: input the password to disarm.

Under disarming, the user can:

Arm: input the password and enter arming delay, leave the area before the delay time's up.

Chapter 4 System Setting

4.1 Time Setting

Click  on the menu \Rightarrow Time Setting, entering in the interface of time setting, to set up time and date for the station.

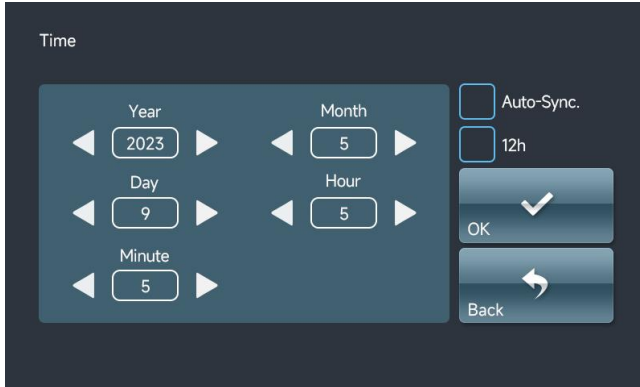

Interface of Time Setting

Open time auto-sync function: Time will be auto-synchronized with the PC time once tick this option.

4.2 Camera Setting

Click  on the menu \Rightarrow Camera Setting, entering in the camera setting interface.

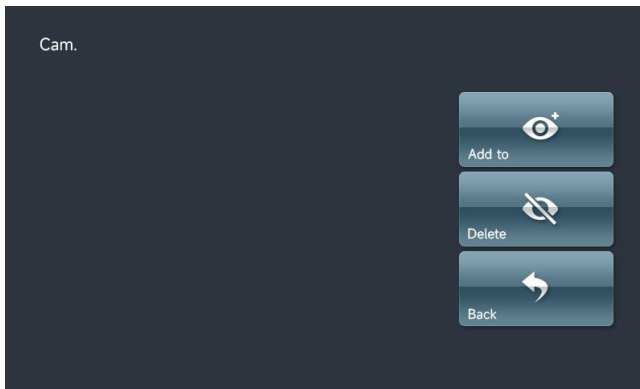

Interface of Camera Setting

To add or delete cameras for this monitor which are setting in the system. Need to input the camera code when add camera.

4.3 Call Divert Setting

Click  on the menu \Rightarrow Call Diverting , entering in the interface of call forwarding setting.

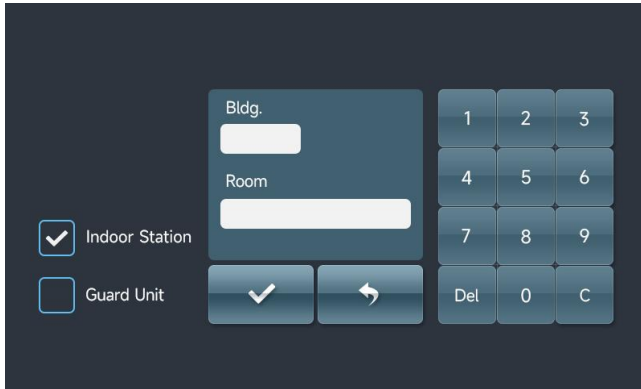

Interface of Call Transfer Setting

- 1) Tick a target facility.
- 2) If it is indoor station, need to input the target room number.

Notice: If choose monitoring station, no need to input code.

4.4 Password Setting

Click  on the menu \Rightarrow Password Setting , entering in the interface of password setting.



Interface of Password Setting

User Password

Input current password (user password or anti-hijack password) \Rightarrow Input new password \Rightarrow Confirm new password.

Anti-hijack Password

Input (user password or current password) \Rightarrow Input anti-Hijack password \Rightarrow Input Anti-Hijack password for the second time.

Need to input user password before process hijack pasHijack

(Notice: hijack password cannot be the same as user password).

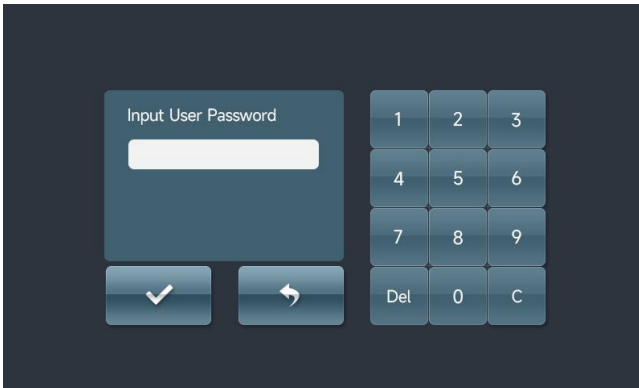

Interface of Hijack Password Setting

4.5 Ringtone Setting

Click  in the menu \Rightarrow Ring tone setting, entering in the interface of ringtone setting.

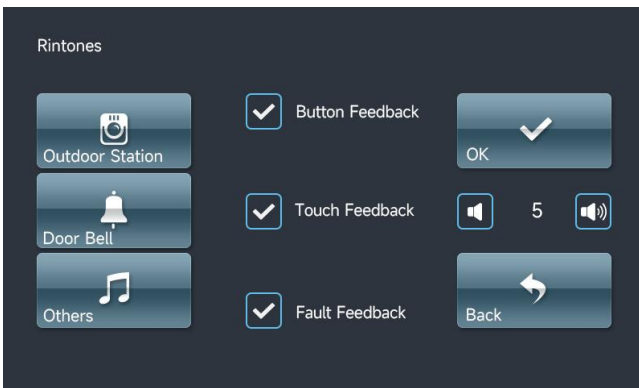

Interface of Ring tone Setting

Volume setting

- 1) Adjust ringtone volume.
- 2) Set up button Feedback、Touch Feedback and Failures Feedback for the sound.

Ring tone selection

Choose the ringtone from the list for each device.

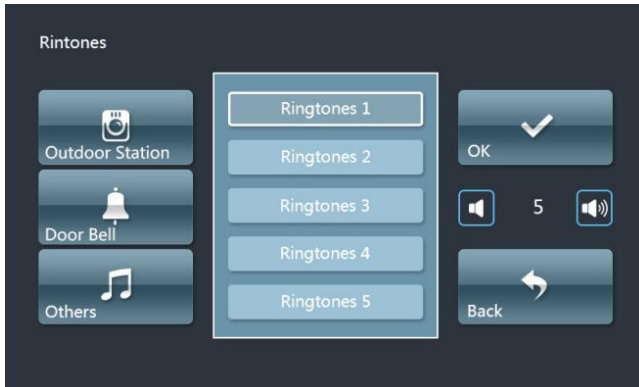

The list of setting ring tones

Options for the incoming call ring tone for every devices.

Notice: Other ringtones in the list mean the ringtone for indoor station, mini outdoor station and management center unit.

4.6 Display Setting

Click  in the menu, \Rightarrow Display setting, entering in the interface of display setting.

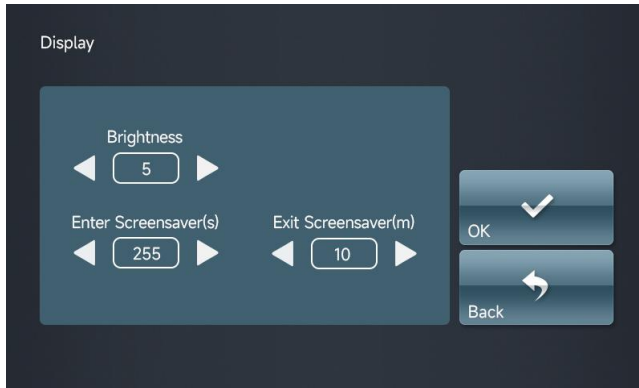

Interface of Display Setting

- 1) Adjustment of the brightness.
- 2) Setting the time for entering and exiting the Screen saver.

4.7 Language Setting

Click  in the menu \Rightarrow language setting, entering in the interface of language setting.

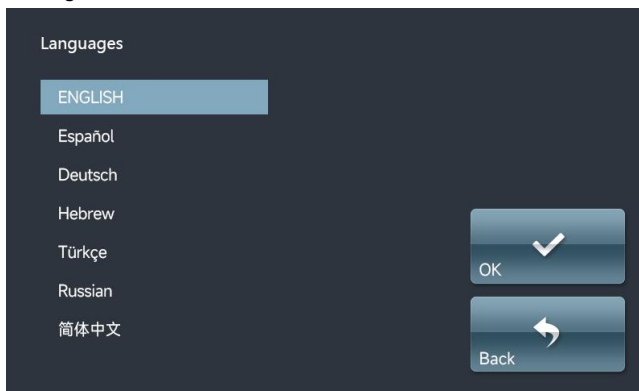

Interface of Language Setting

Language setting should be set up at initial start-up.

4.8 Configuration Setting

Click  in the menu \Rightarrow configuration setting \Rightarrow input configuration password, entering in the interface of configuration setting.

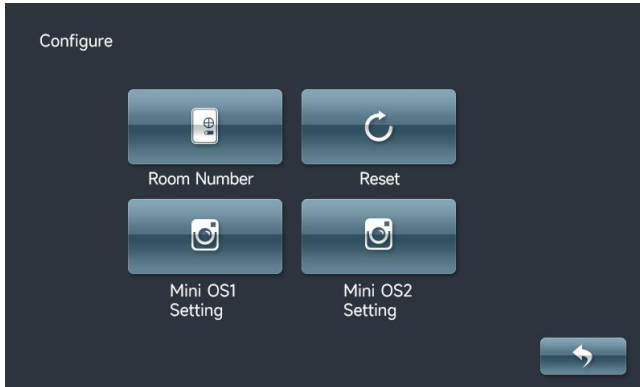

Interface of Configuration Setting

Room No. Setting

Set up room number for this monitor.

Configuration Password: it's used to set the number of indoor monitor, mini outdoor station and to enable factory reset. Default project password is 801801.

Mini Outdoor Station setting

- 1) Enter setting stay for secondary outdoor station.
- 2) Add the station number : Set up \Rightarrow Configuration Setting \Rightarrow Choose mini outdoor station 1setting (or mini outdoor station 2 setting) \Rightarrow Choose the mini outdoor station.
- 3) Confirm via video whether the setting matched target mini outdoor station or not.

NOTE: 1. A list of max. 5 mini outdoor stations will be shown in waiting page.
2. Long press 2s, and short press the button to enter setting page.

Factory Reset



Click Factory Reset button and confirm to reset.

NOTE:

1. Reset after powered for 30s, the device will be reset to factory version.
2. Reset within powered for 30s, the device will be reset to factory version, meanwhile all the history will be CLEANED.

4.9 Screen Clean

When cleaning the screen, in case of wrong operation, lock the screen for the time being.

Click  in the menu \Rightarrow , pop-up window come out for counting down from 60, during this 60s there are no function for touch screen and keys(Except Unlock key), the Unlock key can cancel the screen locking.

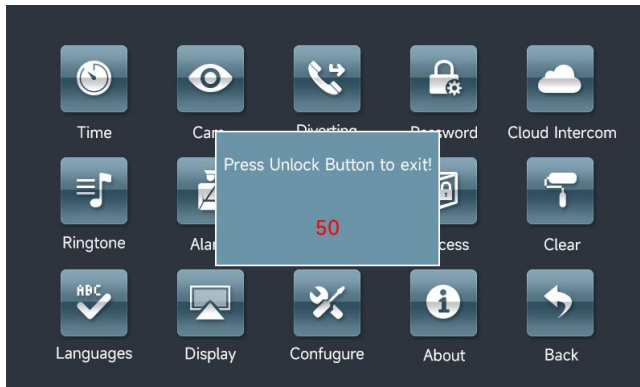

Pop-up interface

- ### NOTE:
1. Use soft and non-fuzzy cloths to clean.
 2. Use a little of glass cleaner will help.

Chapter 5 Smart Home

Click  to enter the smart home control interface.



5.1 Scene

Each indoor extension can be configured with up to 8 scenarios. Click the icons of Scene 1 to Scene 8 to switch directly to the corresponding scenario.

[Note] The scene mode can be configured as independent mode or mutually exclusive mode, and the default is mutually exclusive mode.

Mutually exclusive mode, that is, only one scene can be opened at the same time, and other scenes are closed; independent mode, that is, each scene is independent and does not affect each other, and the user can open multiple scene modes at the same time. If the user needs to configure context independence.

Or modify the scene name to edit the smart home configuration file config.xml. After editing, it can be imported to the indoor unit through the configuration tool to achieve.

5.2 Light

On the smart home control interface, click the light icon to turn on/off the corresponding lighting device. Each indoor extension can be configured with up to 32 lighting devices. Long press the light icon to pop up the light setting interface, which can be set to turn on/off the lighting device and adjust the brightness of the light.

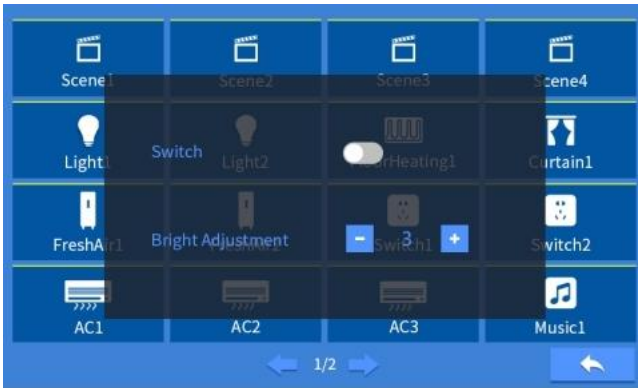

5.3 AC

On the smart home control interface, click the AC icon to turn on/off the corresponding air conditioner. Each indoor extension can be configured with up to 10 air conditioners. Long press the AC icon to pop up the AC setting interface, which can be set to turn on/off the air conditioner, as well as set the mode, wind speed, and temperature.



5.4 Floor Heating

On the smart home control interface, click the floor heating icon to turn on/off the corresponding floor heating equipment, and each indoor extension can be configured with up to 10 floor heating equipment. Press and hold the floor heating icon to pop up the floor heating setting interface, which can be set to turn on/off the local heating equipment, as well as set the wind speed and temperature.



5.5 Fresh Air

On the smart home control interface, click the fresh air icon to turn on/off the corresponding fresh air device. Each indoor extension can be configured with up to 10 fresh air devices. Press and hold the fresh air icon to pop up the fresh air setting interface, which can be set to turn on/off the fresh air device, as well as set the mode and wind speed



5.6 Switch

On the smart home control interface, click the switch icon to turn on/off the corresponding switch device. Each indoor extension can be configured with up to 10 switch devices.

5.7 Curtain

On the smart home control interface, click the curtain icon to turn on/off the corresponding curtain device, and each indoor extension can be configured with up to

10 curtain devices. Press and hold the curtain icon to pop up the curtain setting interface, which can be set to turn on/off the curtain device and control the suspension of the curtain.



5.8 Water Heater

On the smart home control interface, click the water heater icon to turn on/off the corresponding water heater device, and each indoor extension can be configured with up to 10 water heater devices.

5.9 Music

On the smart home control interface, click the music icon to turn on/off the corresponding music device. Each indoor extension can be configured with up to 10 music devices. Long press the music icon to pop up the music setting interface, which can be set to turn on/off the music device, as well as play mode, volume and other settings.



Chapter 6 Installation

6.1 Height Installation

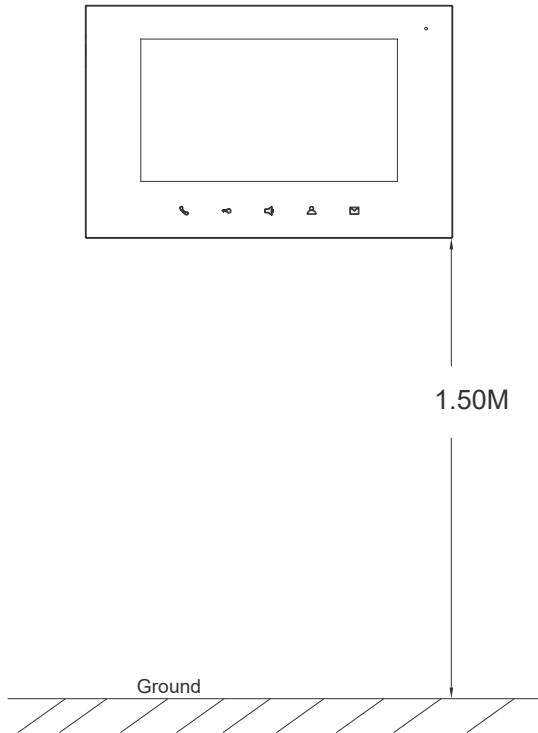

Recommend height: 1.5M

6.2 Installation Illustration

①

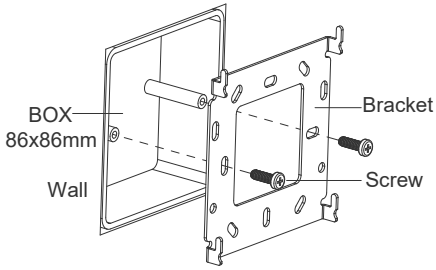

Step 1:

Drive the screws on the bracket with the holes on the 86 box.

Fasten the screws to fix the bracket.

②

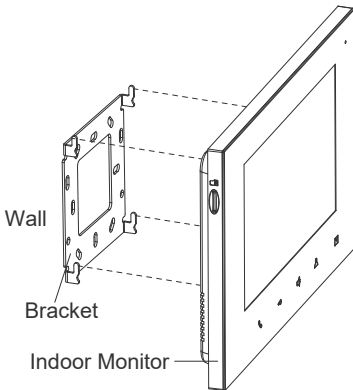

Step 2:

After finishing the wiring of the indoor station, aim the slot behind the indoor station to the hook of the bracket(②).

After aiming correctly, move downward a little to make the indoor station well fastened on bracket.(③)

Finish installation(④)

③

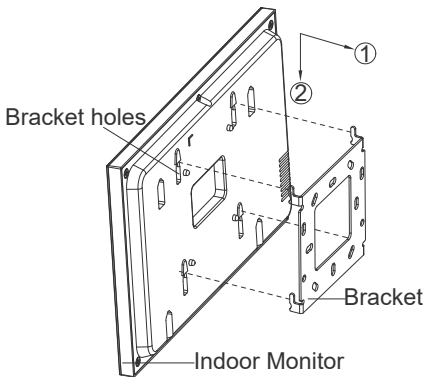

Aligning at the bracket

④

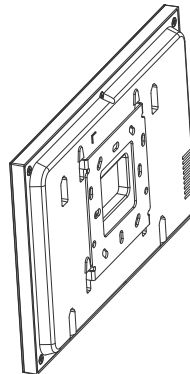

Card in the bracket

Chapter 7 Defense Area Wiring

7.1 Defense Area Wiring Diagram

7.1.1 Single Security Detector Wiring

Indoor monitor Z1 to Z7 wiring:

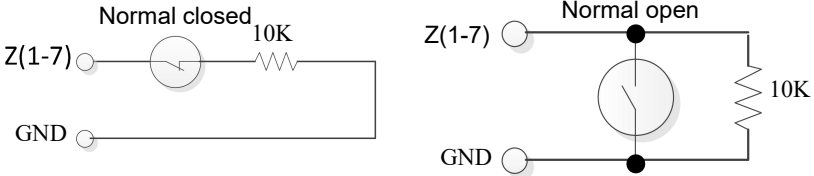

Indoor monitor Z8 wiring:



7.1.2 Multi Security Detectors Wiring

Indoor monitor Z1 to Z7 wiring:

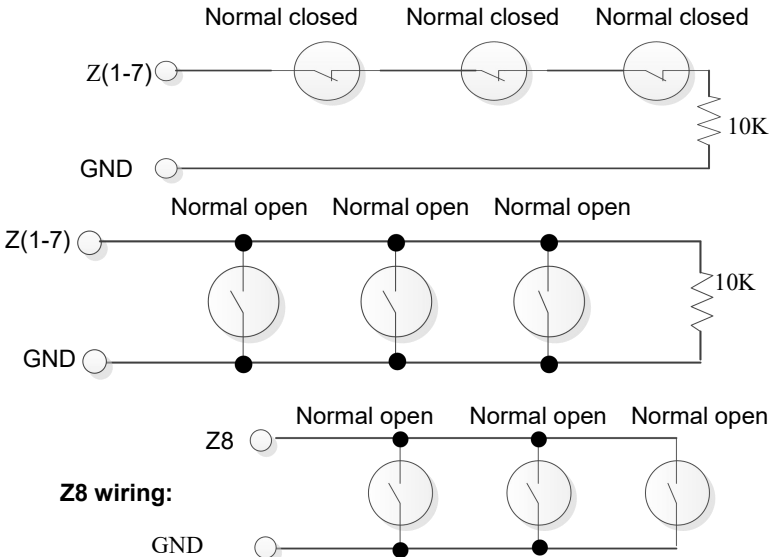

NOTE: Unused defense area interfaces could be closed in the Alarm System Setting, or it can be blocked by 10K resistance.

7.2 Defense area attribute description

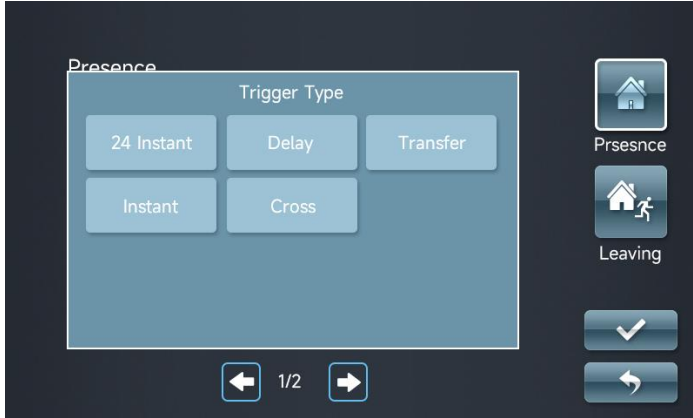

Trigger types interface

24 hours Instant: This defense area will detect as soon as the system is power on, and it will not be influenced by arming/disarming. Once this defense area is triggered, the alarm warning will be sent out immediately.

Delay alarm: After this defense area is armed, once it triggers, then enter the counting down of alarm delay. Users can disarm the defense during the counting down. Otherwise it will send out alarm warning when time is up.

Transferring delay: This defense area is related to the operation of delay defense area. After arming, once this defense area triggers before the delay defense area, it will alarm immediately. If the delay defense area triggers firstly, then enter the counting down of alarm. Users can disarm during the counting down. Otherwise it will alarm immediately when time is up.

Instant alarm: After this defense area is armed, once it triggers, the alarm warning will be sent out immediately.

Cross warning: Two defense areas need to be matched up to trigger this function. After arming, once one of the cross defense areas is triggered, within 5 seconds another cross defense area is triggered, alarm warning will be sent out immediately. Otherwise alarm warning reserved.

7.3 Doorbell Function

Doorbell function can be set by Alarm Setting \rightleftarrows Defense Area Setting \rightleftarrows Detector Type. After the setting, when the defense area detects doorbell input, the doorbell rings immediately.

