

## Outdoor Station

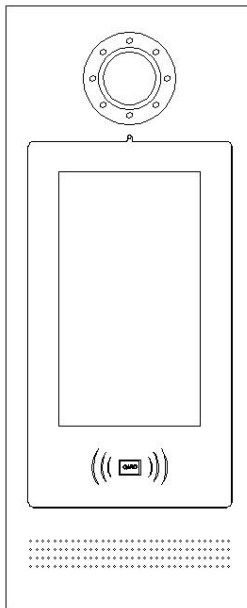

**T - series 7 inch Touch Screen Outdoor Station  
User Manual\_V1.0**

**T-OS11E**

# Attentions

1、 Please keep devices away from strong magnetic field , high temperature , wet environment ;



2、 Please do not fall the devices to the ground or make them get hard impact ;



3、 Please do not use wet cloth or volatile reagent to wipe the devices ;



4、 Please do not disassemble the devices.

# Content

<b>UNIT 1 OVERVIEW</b> .....	<b>1</b>
1.1 FUNCTIONS AND CHARACTERISTICS .....	1
1.2 PARAMETERS .....	1
<b>UNIT 2 APPEARANCE AND INTERFACE</b> .....	<b>2</b>
2.1 APPEARANCE .....	2
2.2 DIMENSION .....	3
2.3 INTERFACE INTRODUCTION .....	4
<b>UNIT 3 INSTALLATION</b> .....	<b>5</b>
3.1 INSTALLATION HEIGHT .....	5
3.2 INSTALLATION STEPS .....	6
3.3 SYSTEM WIRING .....	7
3.4 DOOR LOCK WIRING DIAGRAM .....	9
<b>UNIT 4 OPERATION INSTRUCTIONS</b> .....	<b>11</b>
4.1 CALL BY KEYPAD MODE .....	11
4.2 NAME LIST BY KEYPAD MODE .....	11
4.3 CALL BY RESIDENTIAL LIST MODE .....	12
4.4 CALL GUARD UNIT .....	13
4.5 UNLOCK .....	13
<b>UNIT 5 SETTINGS</b> .....	<b>15</b>
5.1 SETTING LOGINE INTERFAC .....	15
5.2 MAIN SETTING INTERFACE .....	16
<b>UNIT 6 SYSTEM SETTINGS</b> .....	<b>16</b>
6.1 RINGTONE SETTING .....	17
6.2 LANGUAGE SETTING .....	17
6.3 PIN SETTING .....	18
6.4 UNLOCK TIME SETTING .....	18
6.5 ADD SETTING .....	18
6.6 CARD MANAGEMENT .....	19
<b>UNIT 7 CONFIGURATION SETTING</b> .....	<b>21</b>
7.1 CALL MODE SETTING .....	21
7.2 ALARM SETTING .....	22
7.3 DOOR STATUS DETECTION .....	22
7.4 FACTORY TESTING .....	22
7.5 CONFIGURATION PASSWORD .....	24
7.6 DEVICE INFORMATION .....	24

# Unit 1 Overview

This product is an Outdoor Station of 2-Wire analog video door phone system, it makes communication with Indoor Monitor via 2-core cable in the system, the Outdoor Station also supports access control with IC card.

## 1.1 Functions and Characteristics

- Support video intercom and unlocking
- Support real-time monitoring
- Door status detection, and unlock state timeout alarm
- Support tamper alarm
- Support IC Card
- Support connecting external camera

## 1.2 Parameters

### Working Parameter

Working Voltage: DC 24~32V

Static Current:  $\leq 90\text{mA}$  (DC 30V)

Working Temperature:  $-25^{\circ}\text{C}\sim 55^{\circ}\text{C}$

Working Current:  $\leq 400\text{mA}$  (DC 30V)

Storage Temperature:  $-40^{\circ}\text{C}\sim 70^{\circ}\text{C}$

Dimension(W/H/D): 363×148.5×47mm

### Camera

Type: CMOS

Resolution: 30W

View Angle: Diagonal  $70^{\circ}\times 50^{\circ}$

Min. Illumination: 0.1 lux

Focal Length: 2.5mm

Fill-in Light: white

Adjustable Angle: up/down/left/right  $10^{\circ}$

# Unit 2 Appearance and Interface

## 2.1 Appearance



Residential List Mode



Keypad Mode

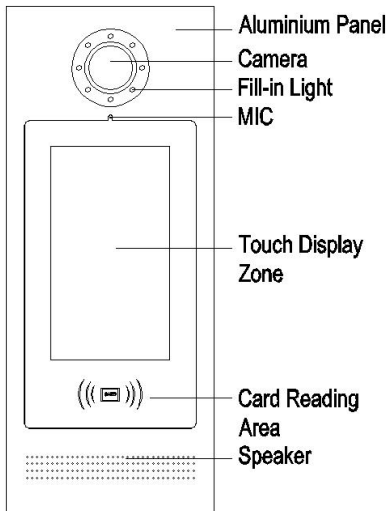

Front View

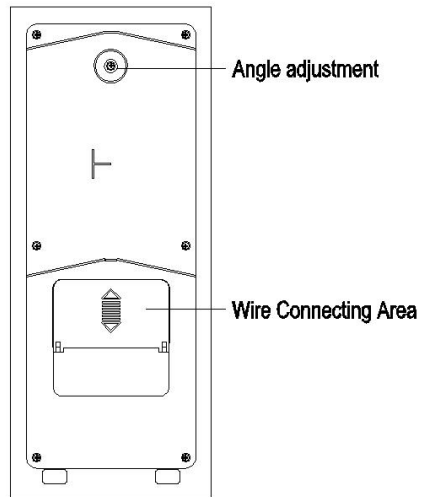

Rear View

## 2.2 Dimension

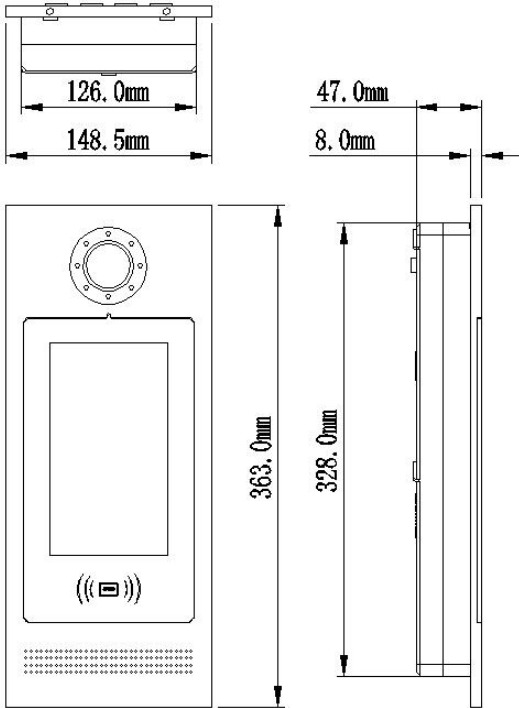

## 2.3 Interface Introduction

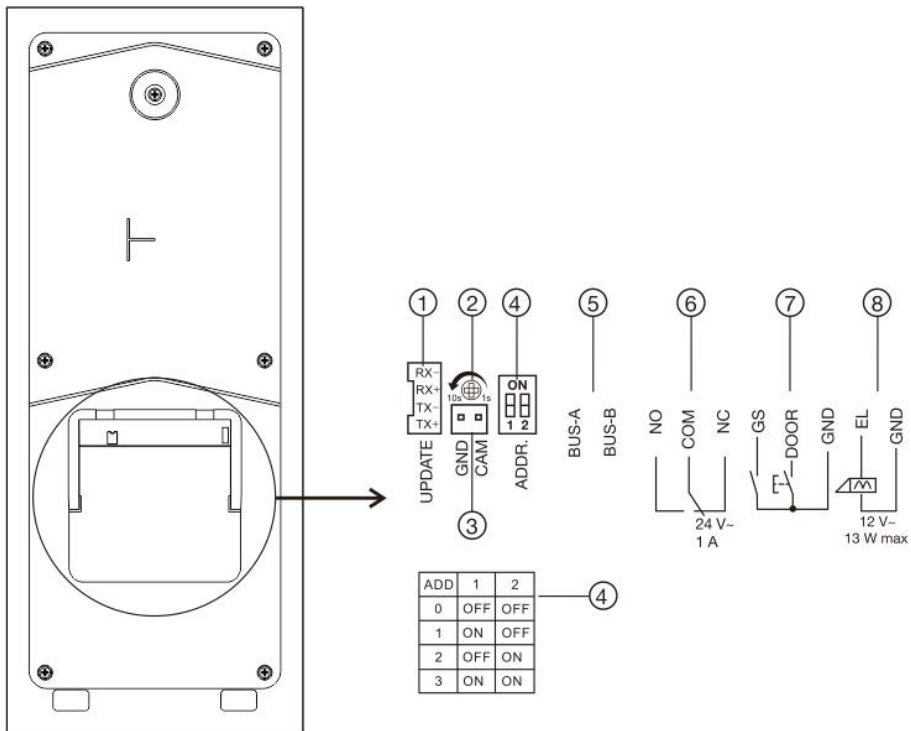

- ① Network(update) Interface (1: TX+ , 2: TX-, 3: RX+, 4: RX-);
- ② Unlock time adjustment: please check “6.4 unlock time setting”;
- ③ External camera;
- ④ Outdoor station address (ADD) setting, please check “6.5 ADD setting”;
- ⑤ BUS-A, BUS-B: 2-Wire BUS interface;
- ⑥ NO, COM, NC: Normally open pin, Common pin, Normally closed pin;
- ⑦ GS: Door status detection;  
DOOR SW: Door unlocking switch;  
GND: Common ground;
- ⑧ EL: Electric control lock;  
GND: Common ground.

# Unit 3 Installation

## 3.1 Installation Height

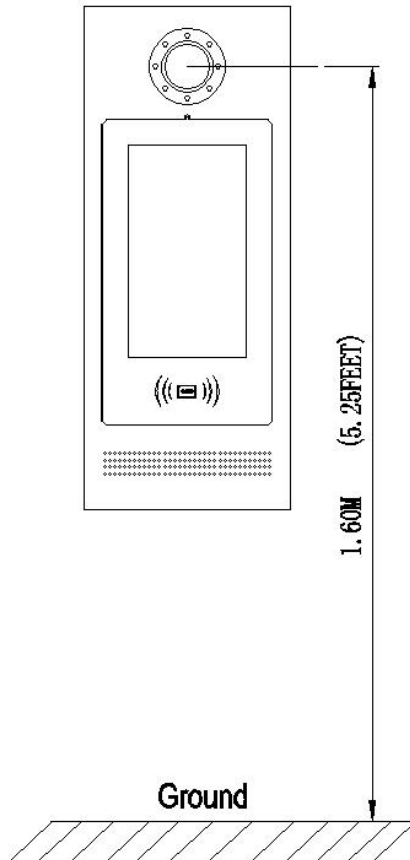

**Suggested height for installation: camera is 1.6m above the ground**

### 3.2 Installation Steps

Step 1: Put the embedded box into the preformed groove (as Pic.2). After getting the cable out through the opening, fasten the box with screws or by cement.

Dimensions of embedded box are as below:

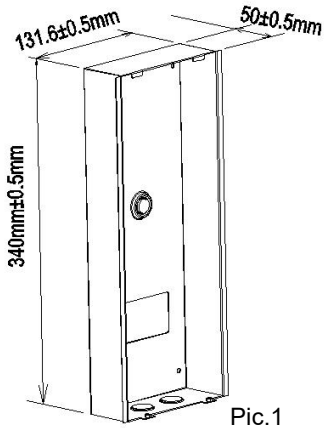

Pic.1

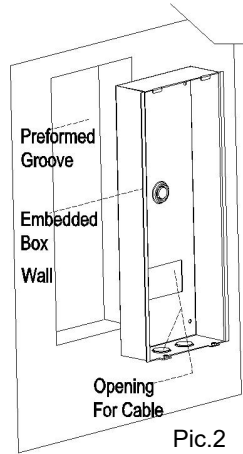

Pic.2

Step 2: After connecting the cable to the Outdoor Station (as Pic.3), match the snap slot of the Outdoor Station to the snap of embedded box and press the outdoor station into the box, then fasten the Outdoor Station to the box with screws (as Pic.4).

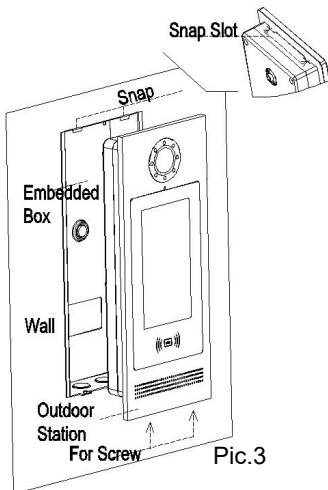

Pic.3

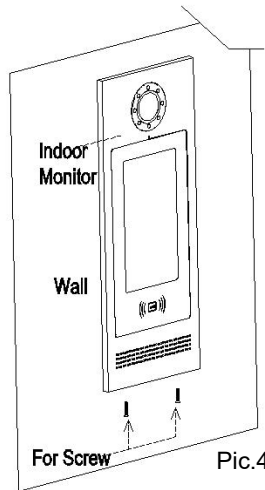

Pic.4

### 3.3 System Wiring

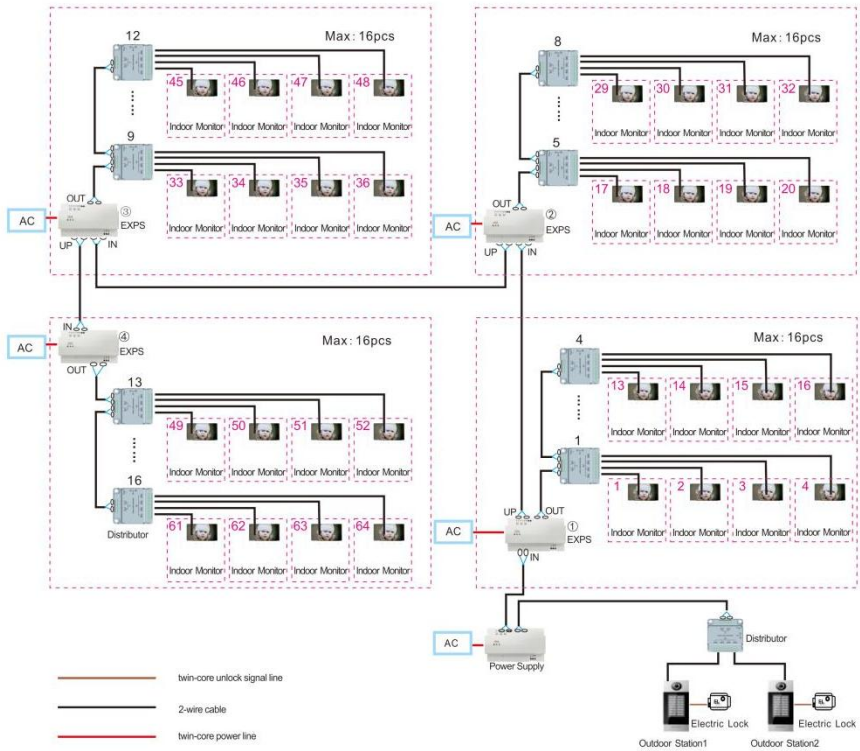

#### Remarks:

① System capacity: 1 System Power Supply + Outdoor Station(Max: 4) + Distributor(no limited) + Indoor Monitor(Max: 200 apartment) + Extended Power Supply(MAX: 16);

② Support multiple Indoor Monitors(Max. 4pcs) in 1 apartment, address of all the Indoor Monitors in one apartment should be same;

**Attention: In case of over current, only 1 Indoor Monitor can be set as master within 1 apartment. Detailed setting refer to the interface introduction of Indoor Monitor.**

③ In the case of having multiple Indoor Monitors in 1 apartment, all Indoor Monitors will ring when they are being called, but only the master Indoor Monitor screen will turn on. If one Indoor Monitor takes the call, the others will hangup automatically;

- ④ Restricted by the power consumption, the system only allows 2 Indoor Monitors turn on the screen (being operated) at the same time (intercom function is not affected);
- ⑤ Distributor is recommended for system wiring (star wiring topology), while Bus topology (hand In/ Out connection) is supported as well;
- ⑥ If the external electric lock needs to take power from Outdoor Station, then Outdoor Station itself must connect the power through the external power supply port, only in this way the power can be given from **lock mode interface**;
- ⑦ Wiring distance A is the Max. Length from Outdoor Station to Power Supply, wiring distance B is the total length from Power Supply to the last Indoor Monitor, wiring length of different types of cable are shown as below;

Specification	(A+B)length/m
RVV 2*0.75mm <sup>2</sup>	160

### 3.4 Door Lock Wiring diagram

- Electrical door lock wiring

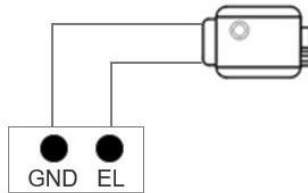

Electric door lock connection (12V)

**Note:** This wiring is non-polarized.

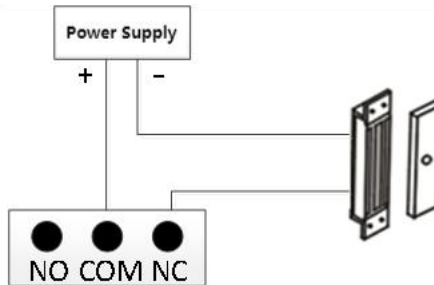

Wiring for normally closed type lock(Magnetic Lock)

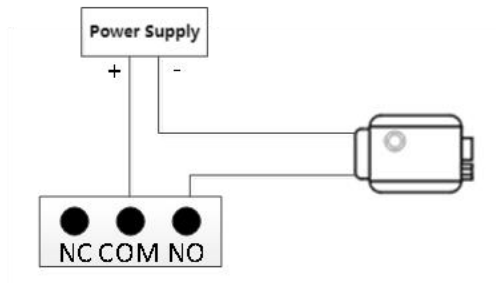

Wiring for normally open type lock(Electronic lock)

**Note:** **DO NOT** power up the door lock from the outdoor station.

- **Exit button unlock wiring**

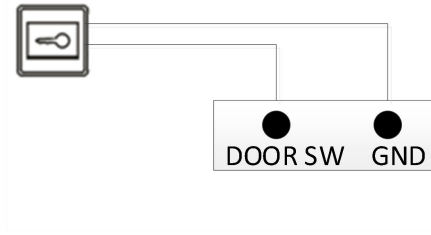

**Note:** This wiring is non-polarized.

- **Wiring for Door Status Alarm**

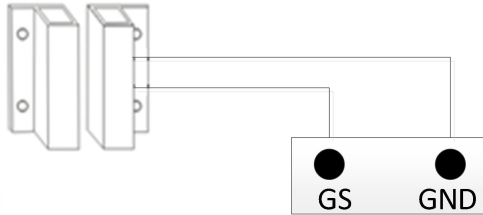



Normally closed type

**Note:** The door status alarm function can be switched off in two ways.

- ① Grounding GS port of the host.
- ② Enter "Door Status Alarm" and turn off the door status alarm switch.

# Unit 4 Operation Instructions

## 4.1 Call by Keypad Mode

In standby state of keypad mode, visitors can input apartment No. and then press  or  to make the call, and the device will enter calling interface with ringback.

If Indoor Monitor is offline, it will return to the standby interface with “Beep” rapidly in 3 times.

If Indoor Monitor is online, it will begin the calling count down and start to play the ringback.

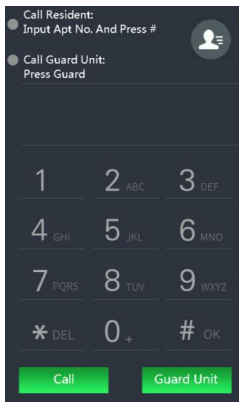

*Standby state of Keypad mode*

**Remark:** The device is using keypad mode as default, users can set the DIP Switch in the back to 0 position and input the correct password to enter configuration setting for mode change, detailed call mode setting please refer to page 18.

## 4.2 Name list by Keypad mode

In standby state of keypad mode, visitors can press  to the show the name list(list needs to be imported by PC configuration tool in advance ).

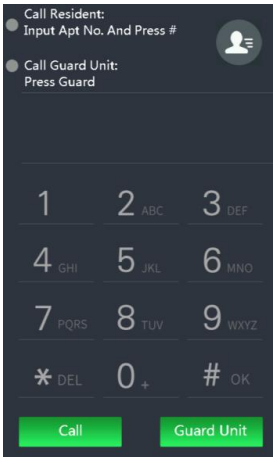



*Standby state of Keypad mode*

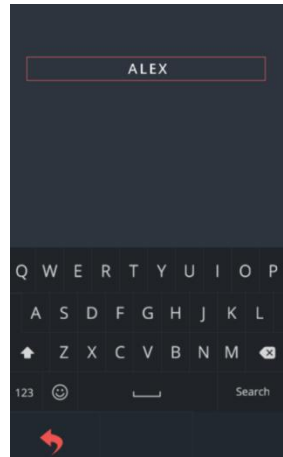

*Name list Interface*



*Name searching Interface*

Visitors can press the exact name in name list to make the call, or click the **input box** to search the resident's name, when the searching is done, click  or  to trigger the search, make the call by pressing the name.

If the device is online, it will begin the calling count down and start to play the ringback.

### 4.3 Call by Residential List Mode

In standby state of residential list mode, visitors can directly press the name tag(001~200) to make the call, and the device will enter calling interface with ringback. If no answer from the resident within 3s, it will return to standby state with 3 rapid "Beep".

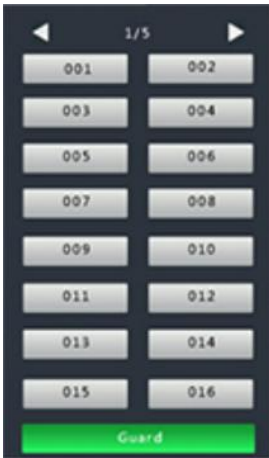

*Standby state of residential list mode*

## 4.4 Call Guard Unit

In standby mode, visitors can press **Guard Unit** to call Guard Unit.

## 4.5 Unlock

### 1) By Swiping Card

Swipe the registered card to the card reading area to unlock the door, and Outdoor Station will show “door opened”.

### 2) By Indoor Monitor

Residents can unlock the door from Indoor Monitor when Outdoor Station is calling or being monitored by Indoor Monitor, and Outdoor Station will show “door opened”.

### 3) By External Button

There is a interface for integration of external push button, when connected, a normal push button can be used to unlock the door.

### 4) By Public Password

If this function is activated, residents can press **#** and wait for 1s to enter public password interface.

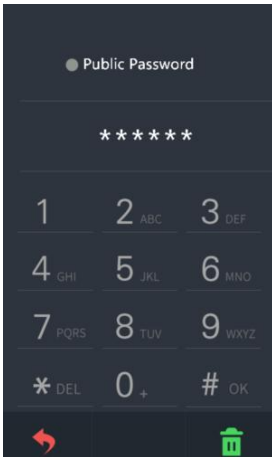

*Public Password Unlock Interface*

In public password interface, input public password and press **# OK** to unlock the door.

**Remark: 1. Default Setting for Public Password Unlock function: Deactivate**

**2. Default Public Password: 666666**

#### 5) By User Password

If User Password Unlock function is activated, residents can press **\* DEL # OK** and wait for 1S to enter public password interface.

In User Password interface, input Apartment No. and related password, then press **# OK** to unlock the door.

**Remark: User password needs to be imported by PC configuration tool, detailed setting refer to PC configuration tool instruction.**

#### 6) Two Door Locks

Lock one is the relay lock, lock two is the 12V electric lock;

The user can open the relay lock when using the swipe card, password and door unlock button.

When unlocking the intercom, Touch-tone indoor unit: press the "unlocking" icon to unlock the relay lock; Press the Info icon to unlock the 12V electric lock.

# Unit 5 Settings

## 5.1 Setting Login Interface

In standby mode, users can press **# OK** **\* DEL** to enter setting login interface.

Default configuration password: **801801**.

**Remark: Users can also enter setting login interface by swiping administrator card.**

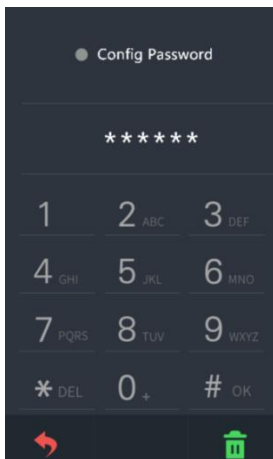

*Setting Login Interface*

## 5.2 Main Setting Interface

After inputting the correct configuration password and **# OK**, main setting interface is shown as below:

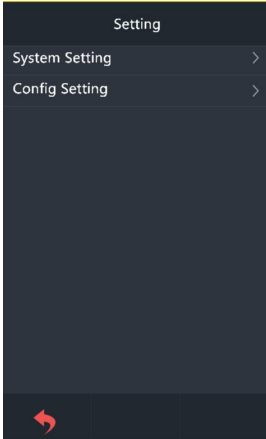

*Main Setting Interface*



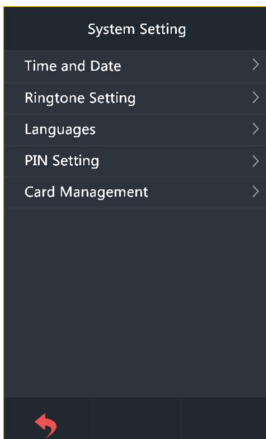

## Unit 6 System Settings

System setting includes Time Setting(reserved), Ringtone Setting, Languages, PIN and Card Management.



*System Setting Interface*

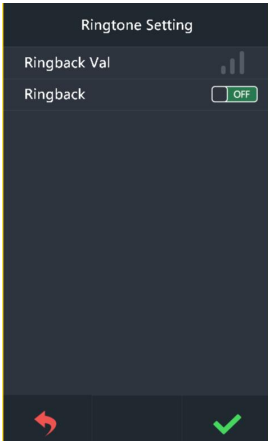

## 6.1 Ringtone Setting

Ringtone setting interface is shown as below, users can press  to adjust volume, press  to turn on / off mute function. After setting is done, press  to save and press  to return last page.



*Ringtone setting Interface*

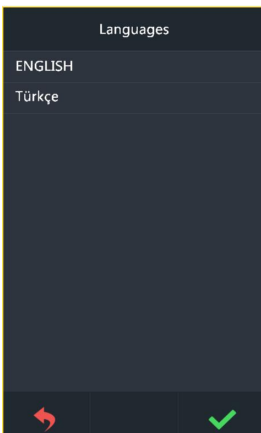

## 6.2 Language Setting

Language setting interface is shown as below, users can select the language and press  to confirm, press  to return last page.



*Language Setting Interface*

## 6.3 PIN Setting

Password setting includes: User Password, Public Password and Public Password Modification. Users can press  to turn on / off unlocked by user password or unlocked by public password. Press  to confirm or press  to return last page.

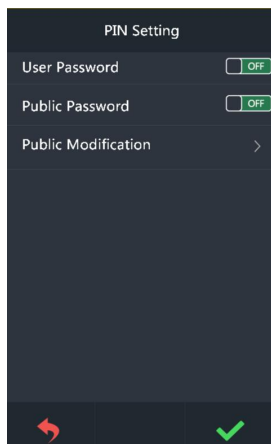

*PIN Setting Interface*

## 6.4 Unlock Time Setting

There is an adjustable potentiometer on the back side of the outdoor station(No.③), unlock time can be adjusted by ratio of 180°from 1 second to 10 seconds, lengthen in anticlockwise direction, shorten in clockwise direction.

## 6.5 ADD Setting

There is a DIP SWITCH at the back of the outdoor station(⑤), the method of setting is as below:

1	2	ADD
OFF	OFF	0
ON	OFF	1
OFF	ON	2
ON	ON	3



Note: It enters setting mode when ADD is 0.

## 6.6 Card Management

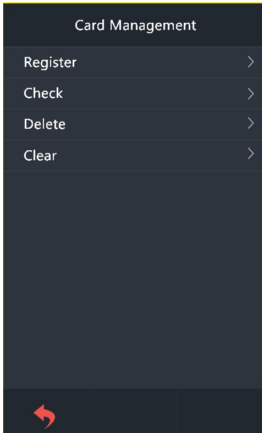
Card management includes register, check(card information), delete, clear(delete all).





*Card Management Interface*

Swipe a card or input the card number to register, after registering finished, press  to confirm, or press  to return last page. While inputting card number, users can press  to delete each number. The operation of card deletion is same as card registration.

**Remark: Capacity of registered card: 2000 cards maximum**

Users can enter “check(card information)” to check all card numbers and the quantity of registered cards.

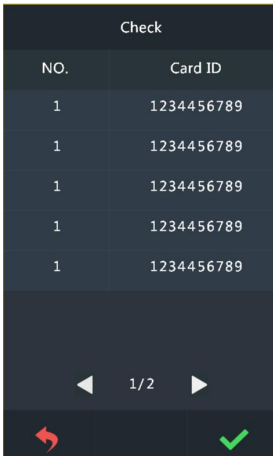

Press   to page up/down the card numbers.



NO.	Card ID
1	1234456789
1	1234456789
1	1234456789
1	1234456789
1	1234456789

*Card Information Interface*

If you choose **Clear**, a message will pop-up to confirm the operation (delete all), press

 to confirm the operation, or press  to return last page.

# Unit 7 Configuration Setting

Configuration setting includes Call Mode Setting, Alarm Setting, Factory Test, Configuration Setting, Company Info(reserved) and Device info. Users can press each icon to enter the relevant setting.

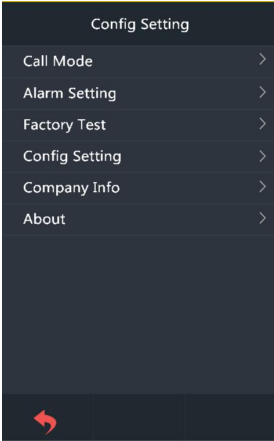

*Configuration Setting Interface*

## 7.1 Call Mode Setting

Call Mode Setting interface is shown as below, users can choose each of the dialing method by pressing their icon, then press  to confirm and the call mode is set.



*Call Mode Setting Interface*

## 7.2 Alarm Setting

Alarm setting interface is shown as below, users can press  to turn on/off anti demolition alarm. The alarm will ring when Outdoor Station is being disassembled by external force.

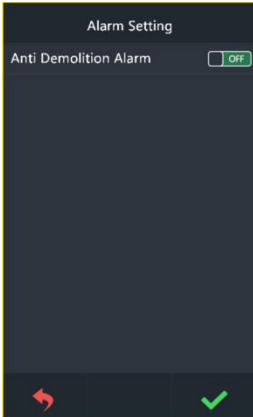

*Alarm Setting Interface*

## 7.3 Door Status Detection

With this function, there will be alarm warning if there's overtime door open status( more than 120 seconds).

## 7.4 Factory Testing

There are various testing programs on factory testing interface, most frequently used are "Reboot System " and "Reset To Factory".

When choosing "Reboot system", choose "confirm" on pop-up box to restart system.

When choosing “Reset To Factory”, choose “confirm” on pop-up box to restore the system as factory setting, using residential list mode, all settings (For example the device properties , volume etc.) will be restored as factory setting.

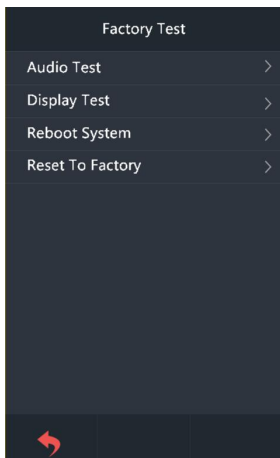

*Factory Test Interface*

**Remark:**

1. Resetting device within 60s after power on, all data will be erased (name list, card list, private unlock password);  
Resetting device after 60s since power on, it will only restore factory setting.
2. After resetting, the first registered card will be treated as Admin card.
3. After resetting, the default call mode will be residential list mode.

## 7.5 Configuration Password

To change the configuration password: input the current password, move to new password box for entering new password.

If entering the new password you input correctly twice, it will save the modification.

Password number limitation: 6 digits.

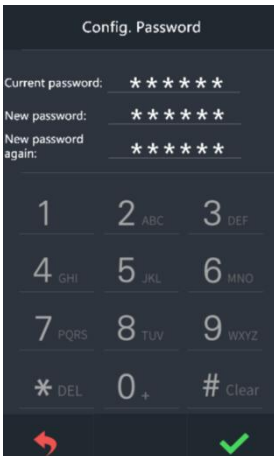

*Configuration Password Interface*

## 7.6 Device Information

In device information interface you can find the version of software and MCU.

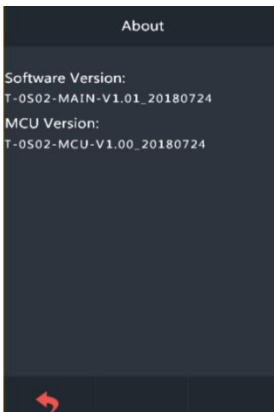

*Device Information Interface*