

Indoor Monitor

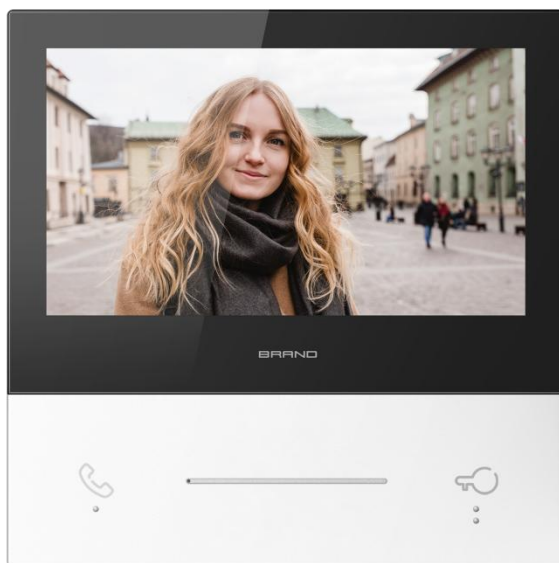

T Series 7" Indoor Monitor User Manual_V1.0

T-IS19

Attentions

1、 Please keep devices away from strong magnetic field , high temperature , wet environment ;



2、 Please do not fall the devices to the ground or make them get hard impact ;



3、 Please do not use wet cloth or volatile reagent to wipe the devices ;



4、 Please do not disassemble the devices.

Contents

Chapter 1 Functional Overview	2
Chapter 2 Product Introduction	3
2.1 Product Appearance	3
2.2 Product size	4
2.3 Interface Description	5
2.4 Specifications	6
Chapter 3 Basic Functions	7
3.1 Power on	7
3.2 Answering a call	7
3.2 Function details	8
3.2.1 Record	8
3.2.2 Wallpaper	10
3.2.3 Call	10
3.2.3 Voice Message	11
3.2.4 Monitor	12
3.2.5 DND	14
3.2.6 Bind	14
3.2.7 Setting	14
Chapter 4 Install	23
4.1 Installation height	23
4.2 Installation Instructions	24

Chapter 1 Functional Overview

This product is a two-wire embedded indoor monitor, which can be connected to the power supply and door station through two-core wires to form a two-wire analog video intercom system. The product functions are as follows:



- **Support visual intercom, remote unlock**
- **Support real-time monitoring of outdoor station**
- **Support multiple indoor monitors in one apartment**
- **Support indoor intercom and external intercom**
- **Support remote visual call, unlock and monitor to two-wire outdoor station via Tuya Smart APP**

Chapter 2 Product Introduction

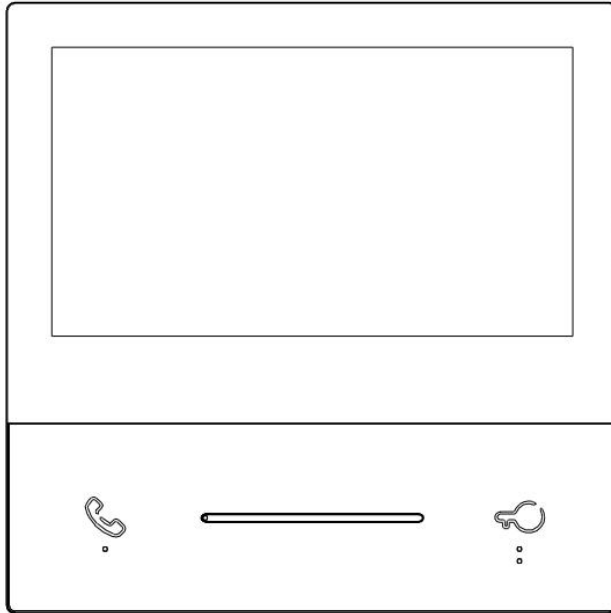
2.1 Product Appearance



Touch button description:

- (1)  : dial, answer, hang up ;
- (2)  : unlock.

2.2 Product size

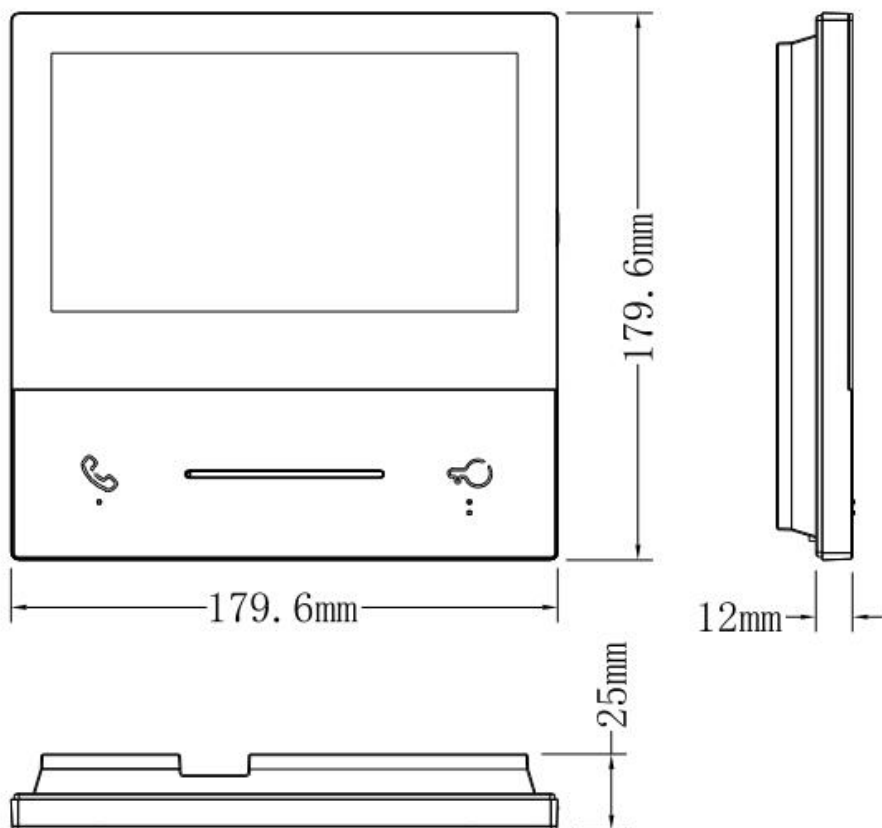

2.3 Interface Description

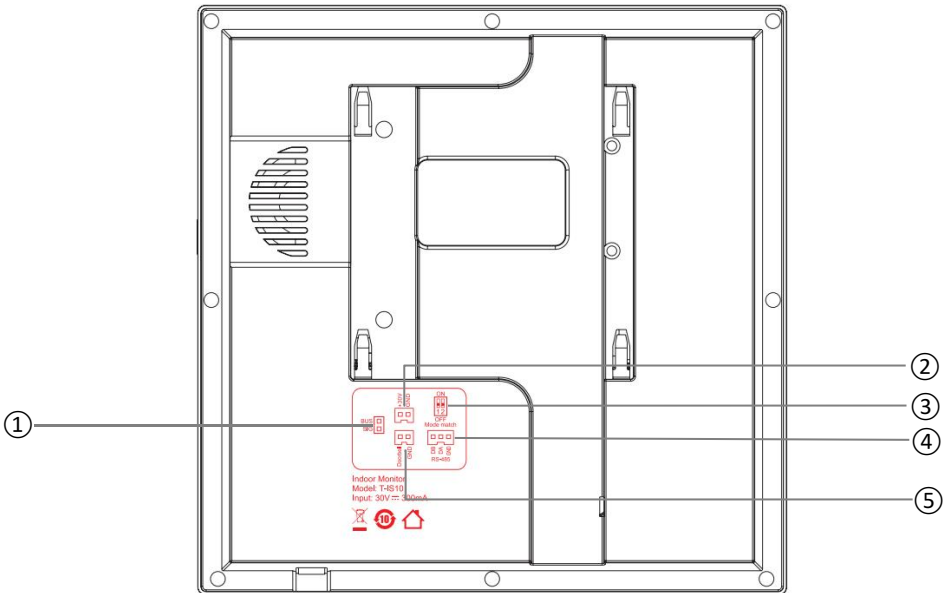

(1) No. ① : Two-wire bus interface ;

The positive and negative wiring has no polarity, and can be connected to the two-wire system at any BUA, BUSB or BUSB, BUSA.

(2) No. ② : Independent power supply interface (DC 21 ~ 32 V);

After the indoor unit is powered by DC, it switches to DC power and disconnects the bus power. If the device is powered by DC, when the device enters the system setting screen, the screen will light up directly without requesting the power supply; if the device is powered by bus, it must apply to the power supply for use. If the power supply allows, the screen will light up, and the system status light flashing indication is not allowed.

(3) No. ③ : Master and Slave selection/ Matching switch;

M/S master and slave dip switch, if one household has multiple extensions, to reduce the load of multiple indoor monitors on the bus, it is recommended that one household has one master device, and other indoor monitors should set as slave extension. When one household has multiple indoor units, when the indoor monitor receives a call, the master device will turn on the screen and ring at the

same time, while the slave extensions will only ring without turning on the screen. However, when the device is powered by DC, both the master and slave extensions will turn on the screen when there is a call.

(4) No. ④ : RS485 interface (reserved function).

RS485 interface, reserved function.

(5) No. ⑤ : Doorbell interface.

An external doorbell button is used to detect the doorbell input. When the doorbell is triggered, the indoor unit plays the doorbell tone.

2.4 Specifications

Working voltage: DC 12 ~ 30 V

Quiescent current: ≤ 90 mA (DC 30V)

Working current: ≤ 250 mA (DC 30V)

LCD Display: 7 inches

Resolution: 800×480

Dimensions (L × W × D): 179.6 × 179.6 × 12 mm

Working temperature: -10°C ~ +55°C

Storage temperature: -30 °C ~ + 70 °C

Chapter 3 Basic Functions

3.1 Power on



First power-on (using bus power supply +30V or independent power supply DC +12-30V) → click the screen to enter the language selection interface, select the corresponding language, click OK → enter the main interface.

3.2 Answering a call

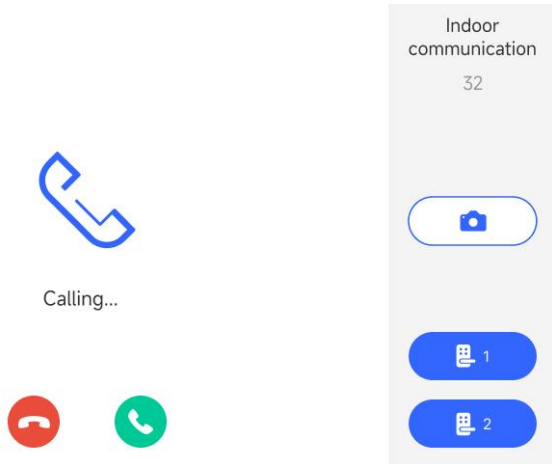
Basic process: Ringing ⇨ Call ⇨ Unlock ⇨ End call



When a call comes in:

- 1、 The visitor calls the indoor phone through the door phone, and the indoor monitor starts ringing ;
- 2、 Residents press  icon , you can start a conversation with the visitor ;
- 3、 During the call, the resident presses  to unlock the door for visitors. After unlocking, the monitor will automatically hang up after 5 seconds and return to the main interface .
- 4、 Residents press  to end the call.

5、 During the call, you can press  to take a snapshot of the visitor.

Notice:

(1) By default, the system automatically captures a visitor photo in the first 3 seconds of a call. You can also capture photos manually, and the captured photos will be saved in the call log.

(2) When the outdoor station is configured with 2 locks , you can click  to open lock 2 for the visitor.

(3) Supports cloud intercom and unlocking between the bound APP account and the 2 wire system devices.

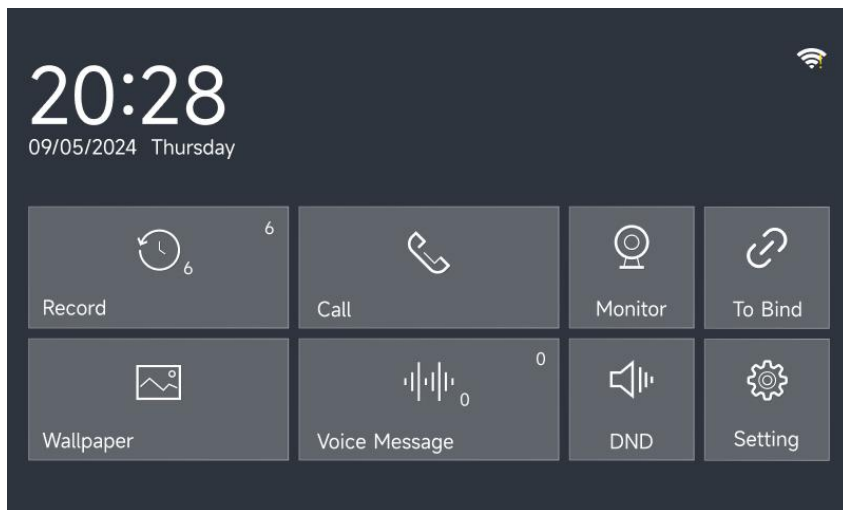

3.2 Function details



This indoor monitor mainly includes 8 functions: Record, Wallpaper, Call, Voice Message, Monitor, DND, Bind, and Setting. See the following detailed description.

3.2.1 Record

Record is used to store the call records of the indoor monitor. Click the icon on the main interface  to enter the call record interface, as shown below.

< Back	Record	Clean All
• Outdoor station1	 2023-12-28 11:06 >	
• Outdoor station1	2023-12-28 11:06 >	
Outdoor station1	 2023-12-28 11:06 >	
Outdoor station1	 2023-12-28 11:06 >	
Outdoor station1	2023-12-28 11:06 >	
Outdoor station1	2023-12-28 11:06 >	
Outdoor station1	2023-12-28 11:06 >	

1. Clear: Click the “Clean All” to clear all call records.

2. Delete: Select the record to be deleted, slide to the left to display the delete button to execute the deletion.

3. View: Users can view the recent 200 call records. Click a call record to view the snapshots or videos taken during the call. Click the Delete button to delete the call record.

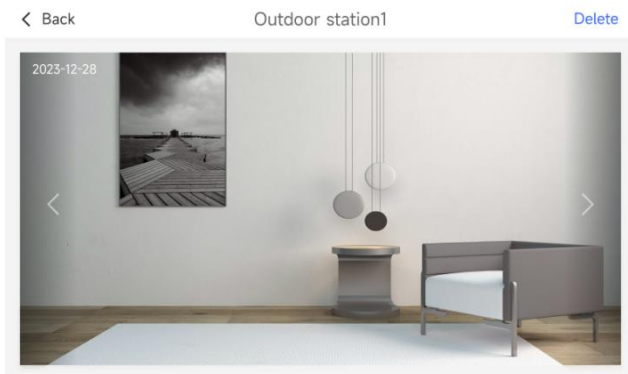

3.2.2 Wallpaper

Wallpaper is used to set the background wallpaper of the indoor monitor. Click the icon on the main interface  and the background selection interface will appear, as shown in the figure below.

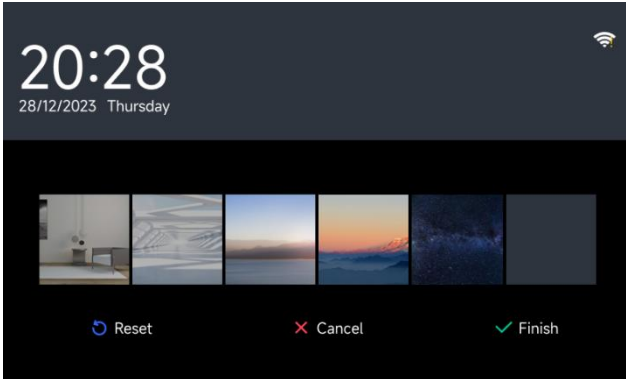

1. Click to select the background image you want to set, and click “Finish” to set the main interface to the background image.
2. Reset: reset to the default background image; Cancel: cancel and return to the main interface.

3.2.3 Call

Call is used for dial-up calls of external Intercom and internal intercom. Click the icon on the main interface  to enter the dial-up call interface, as shown in the figure below.

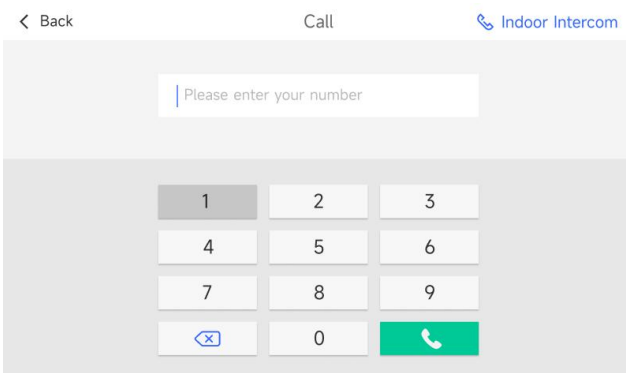

1. Intercom

Enter the correct room number (1-200) in the input box and click  the icon to call the indoor monitor of the corresponding room number.

2. Call Guard Unit

Enter 200 in the input box and click  the icon to call the guard unit.

3. Internal Intercom

Click the Indoor Intercom icon to call the indoor unit, as shown in the figure below.



Calling...

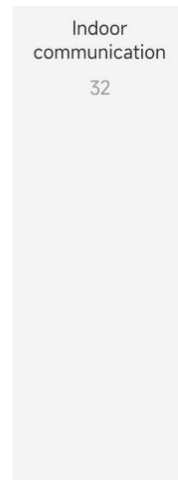

Click  to hang up the call.

3.2.3 Voice Message

Voice Message is used for users to record messages. Click the icon on the main interface  to enter the voice message interface, as shown in the figure below.

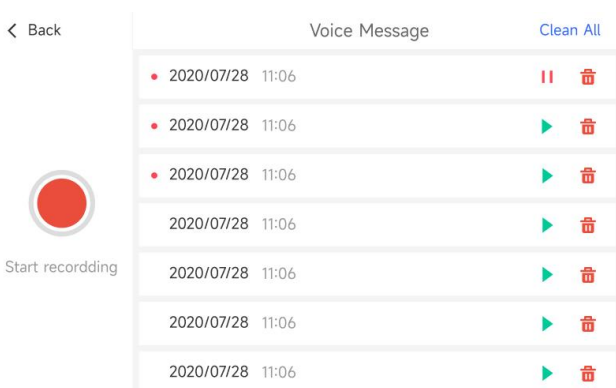

1. Leave a message

Click the red recording button on the left to start recording → click the red recording button again to end, in this way to record and generate a voice message.

(Note: The voice recording time is 30S, and the recording will automatically end when it exceeds 30S)

2. Play

Click the voice message play button on the right to play the voice message.

3. Clear:

Click the “Clean All” button to clear the current voice list.

4. Delete:

Select the message record to be deleted, slide it to the left to display the Delete button, and click it to delete the record.

Notice

Currently, you can record up to 30 voice messages. Once all 30 messages are left, the earliest message will be overwritten.

3.2.4 Monitor

Click the icon on the main interface  to enter the monitoring interface, where you can monitor the outdoor station, as shown in the figure below.

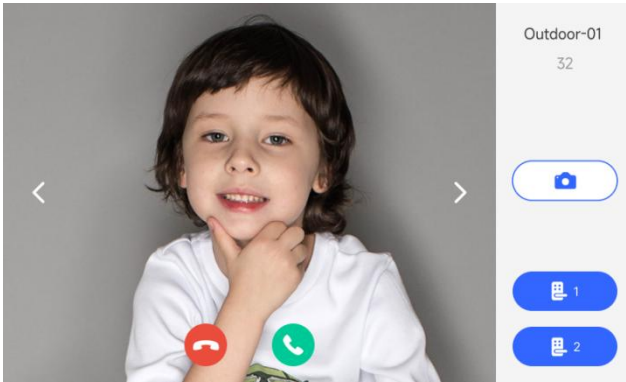

1. Monitor unlocking

(1) Basic process: switch left and right to select monitoring device \Rightarrow Monitoring \Rightarrow Unlocking \Rightarrow Ending call

(2) During the monitoring process, the resident clicks  to unlock the door for visitors.



(3) Click  to end monitoring.

2. Surveillance and capture

(1) During monitoring, click the icon , you can manually capture pictures.

3. Monitor calls

(1) Basic process: Monitoring \Rightarrow Call \Rightarrow Ending call

(2) During the monitoring of the outdoor station, residents can click the icon  to talk to the visitor and press  the button to end the call.

Notice:

(1) The captured picture will be saved in the call log.

(2) When the outdoor station is configured with 2 locks, you can click  to open lock 2 for the visitor.

4. Supports remote monitoring of 2 wire system outdoor station by bound App account. When the bound mobile phone APP remotely monitors the outdoor station, the indoor monitor of the main extension enters the cloud intercom

status and cannot be operated. Its indoor extension enters the standby state and cannot monitor the outdoor station.

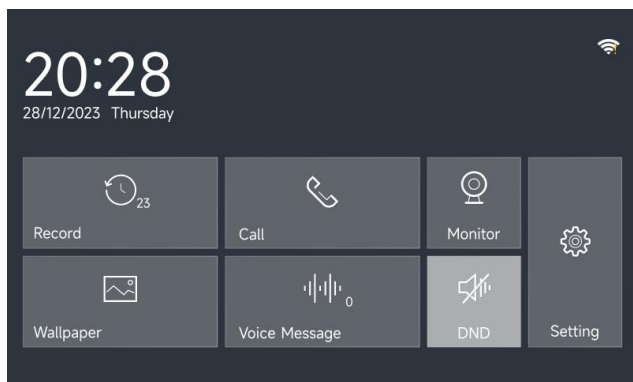

3.2.5 DND

Click the icon on the main interface  to turn on the Do Not Disturb function , as shown in the figure below.



Short press to mute the monitor itself, long press for 3s to mute all indoor devices.

3.2.6 Bind

Click  to jump to the cloud intercom binding setting interface, where you can perform cloud intercom binding operations; after successful binding,  the icon will be hidden on the main interface.

3.2.7 Setting

Click the icon on the main interface  to enter the setting interface, where you can set various parameters of the indoor unit, such as Display Setting, Warning Tone, etc.

1. Display Setting

Click the “Display Setting” on the left menu bar to enter the Display Setting interface.

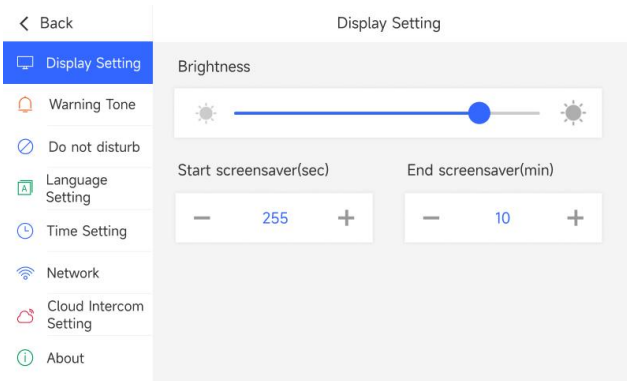

- (1) Brightness: Slide the slider to adjust the screen brightness;
- (2) Start screensaver(sec): Set the screen saver time, which can be set to 30-255 seconds.
- (3) End screensaver(min): Set the screen saver end time, which can be set from 1 to 10 minutes. After the screen saver time ends, the system enters the black screen standby state.

2. Warning Tone

Click the “Warning Tone” on the left menu bar to enter the Warning Tone interface.

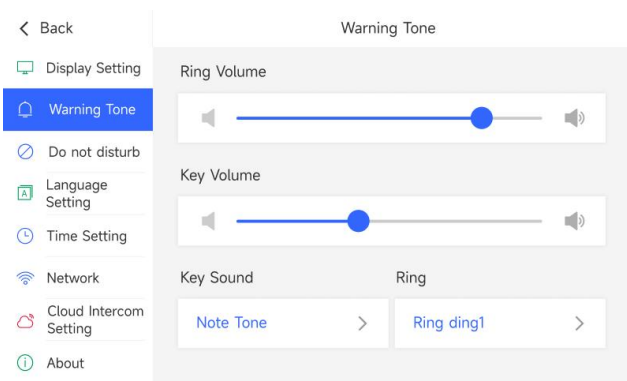

Ring 1 to 5

- (1) Ringing volume: Use the slider to adjust the ringing volume.
- (2) Key volume: Slide the slider to adjust the key volume.
- (3) Key sound: Select the key sound type.
- (4) Ring: Select the ringtone type.

3. Do not disturb

Click the Do not disturb item in the left menu bar to enter the Do not disturb interface.

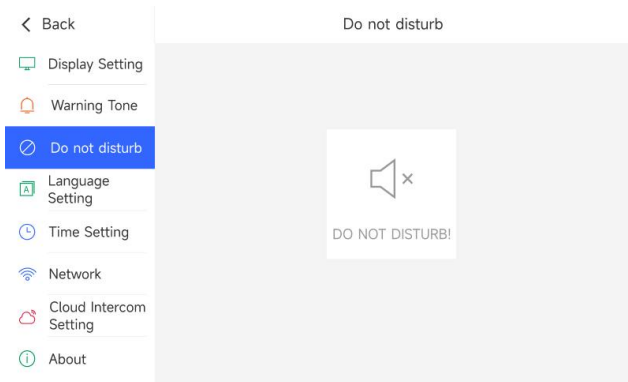

- (1) Do not disturb: Click the Do not disturb button to turn on the ringing mute function.
- (2) When one household has multiple indoor monitors, long press the Do not disturb icon to mute all phones simultaneously, short press the icon to mute the current device.

4. Language Setting

Click the “Language Setting” on the left menu bar to enter the Language Setting interface.

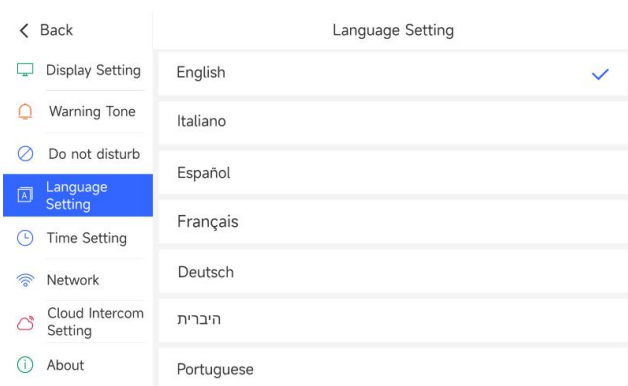

(1) Language Setting: You can choose English, Italian, Spanish, French, German, Hebrew, and Portuguese.

5. Network

Click the “Network” on the left menu bar to enter the Network interface.

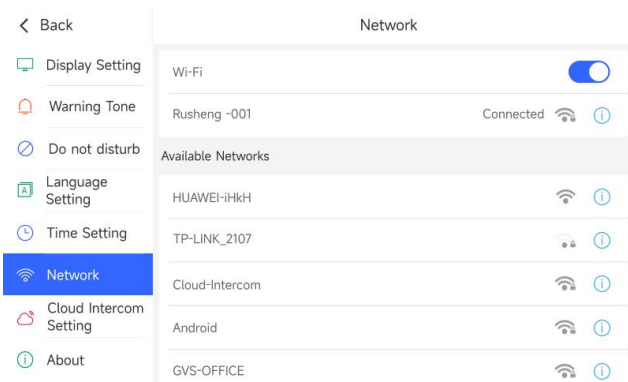

(1) Wi-Fi switch: You can choose to turn on/off WiFi.

(2) Available Networks: List of available WiFi networks. Click to select an available WiFi network to connect.

6. Cloud Intercom Setting

Cloud Intercom Setting is mainly used to bind and unbind the Cloud Intercom APP account. Click the Cloud Intercom Setting item in the left menu bar to enter the Cloud Intercom Setting interface.

If it has been bound, it will be displayed as follows:

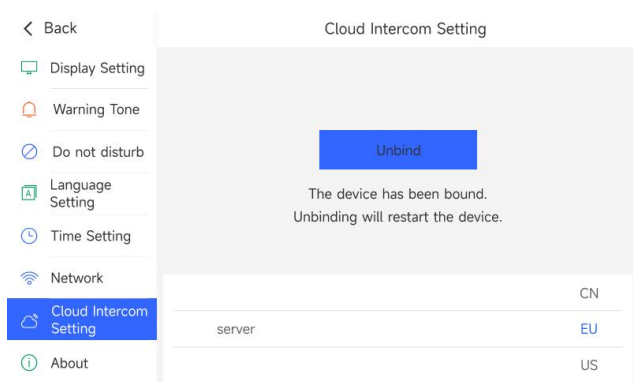

If not bound, the display is as follows:

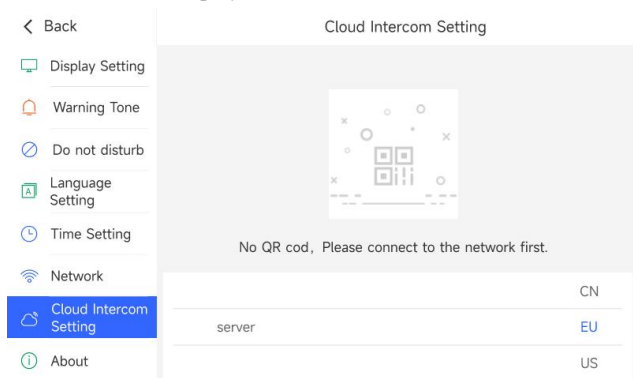

(1) Bind APP: Enter the Cloud Intercom page, open Tuya App or Smart Life to scan the QR code on the interface.

If you enter this page and it is not bound, the Tuya connection QR code will be displayed. If it prompts "No QR code", please check the device network and whether the WIFI connection can access the external network. The indoor unit QR code needs to be pulled from the server. Before APP binding, you can select the server. After binding, you cannot select the server again. You must unbind it before you can select it again.

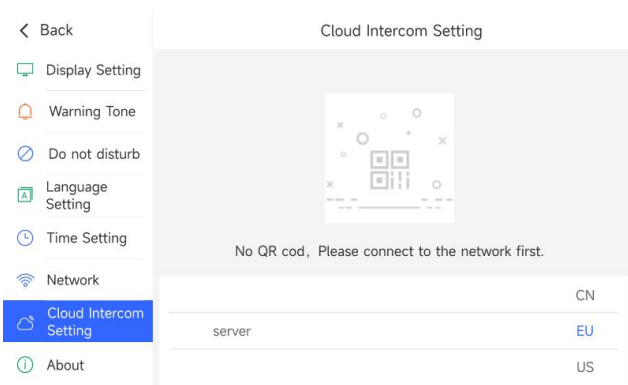

(2) Unbinding: Click Unbinding → A pop-up window will appear. Click the “Confirm” button to unbind the indoor monitor from the APP account and enter the unbound state. After unbinding, the indoor monitor will restart, and the APP will also unbind the indoor monitor.

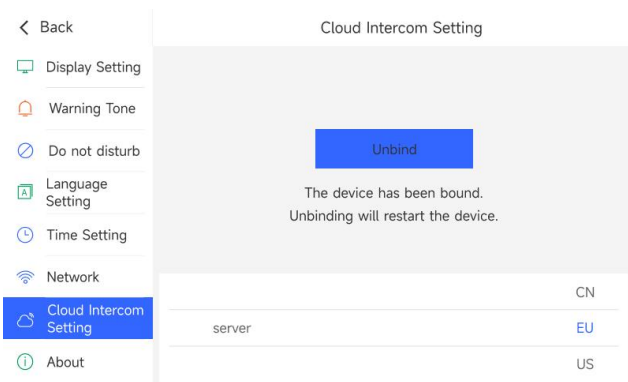

7. About

About is mainly used to view the device's Software Version, MCU Version, Cloud intercom, Room number, Gateway, MAC, Center Server and SIP Server. Click the “About” in the left menu bar to enter the About interface.

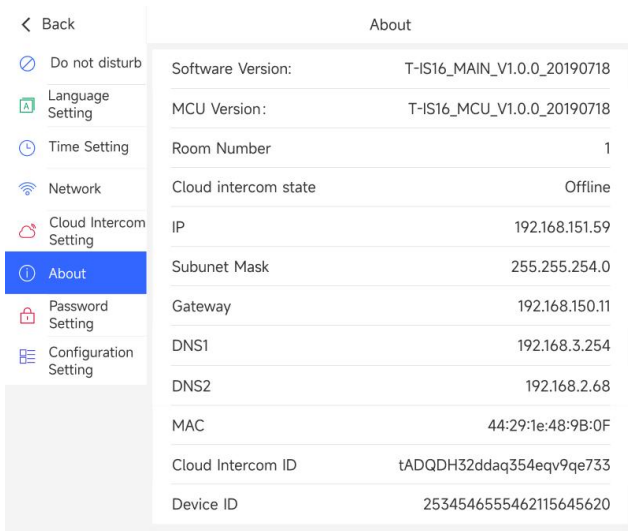

8. Password Setting

Password Setting is mainly used to reset the user password. Click the “Password Setting” in the left menu bar to enter the Password Setting interface.

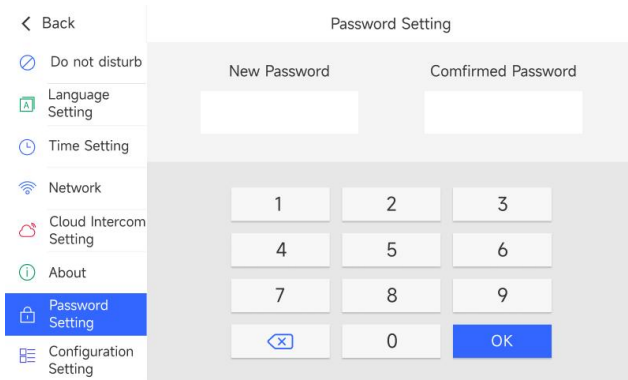

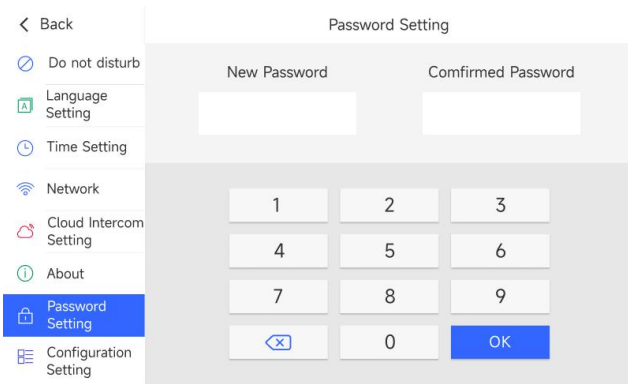

Reset user password process:

Enter the project password and click the OK button. When the password is correct, jump to the user password setting interface, enter the new password and confirm the new password, and click the OK button.

9. Configuration Setting

Configuration Setting Enter the project password (801801) to enter the project setting, and enter the user password (Default user password 666666) to enter the user setting.

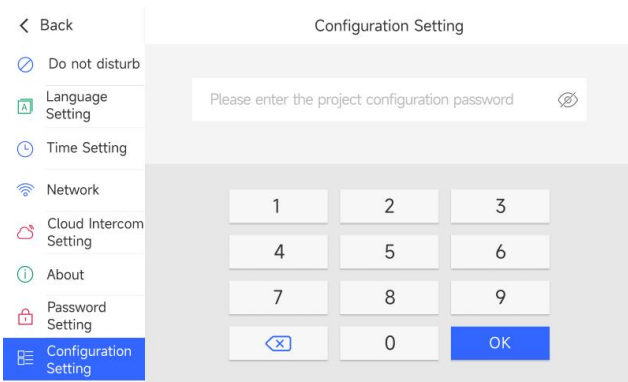

- Enter the project password 801801 to enter the project settings interface.

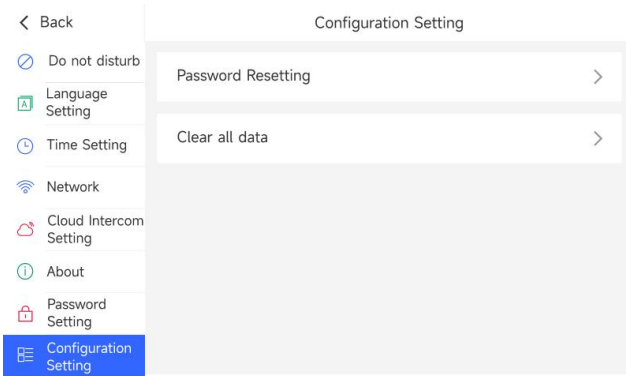

- (1) Password Resetting: Reset the user password to the initial user password 666666.
- (2) Clear all data: Clear all data, including passwords, images, videos, etc.

- Enter the user password (the initial password is 666666) to enter the user settings interface.

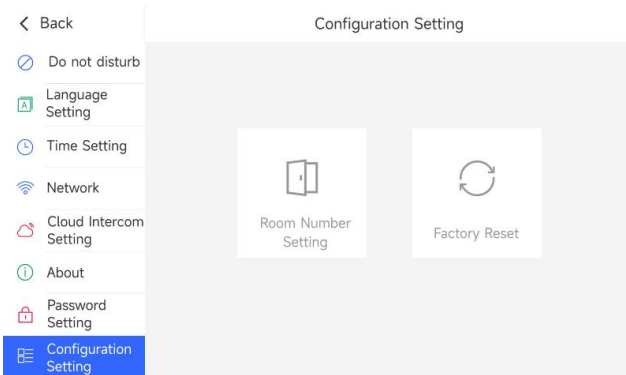

- (1) Room Number Setting: Set the room number, room number address range: 1~200.
- (2) Factory Reset: Restore factory settings. After restoration, all setting values are set to default values.

Chapter 4 Install

4.1 Installation height

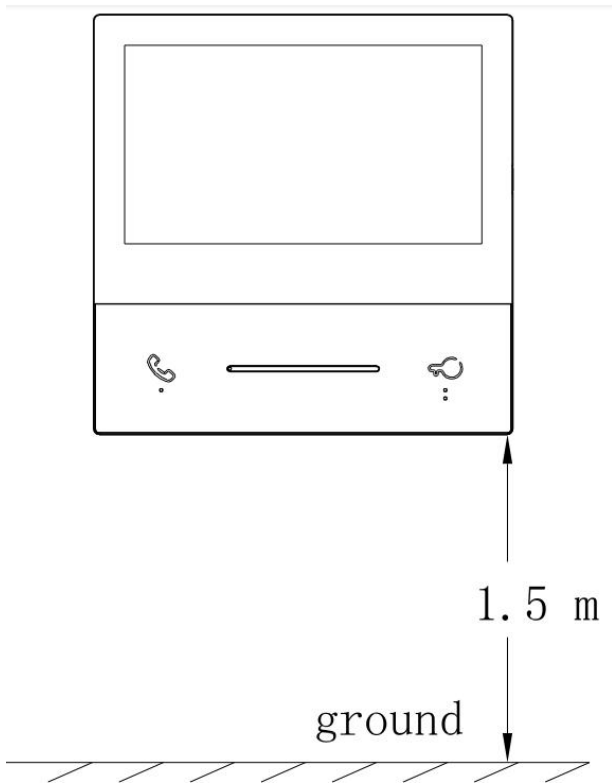

4.2 Installation Instructions

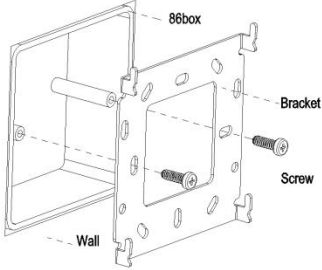
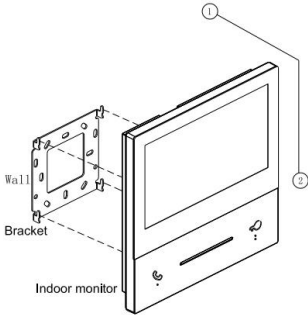
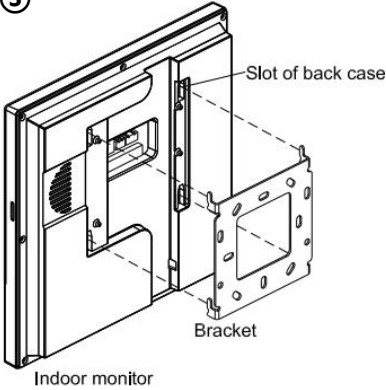
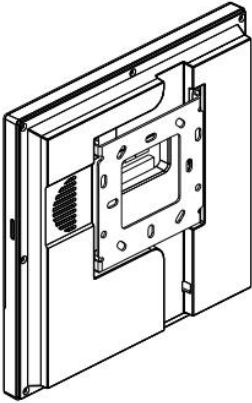
<p>①</p>  <p>86box</p> <p>Bracket</p> <p>Screw</p> <p>Wall</p>	<p>Step 1:</p> <p>Drive the screws on the bracket with the holes on the 86 box.</p> <p>Fasten the screws to fix the bracket</p>
<p>②</p>  <p>Wall</p> <p>Bracket</p> <p>Indoor monitor</p>	<p>Step 2:</p> <p>After finishing the wiring of the Indoor Monitor, align the slot behind the Indoor Monitor to the hook of the bracket.</p> <p>After aligning correctly, move downward a little to make the Indoor Monitor well fastened on bracket.</p>
<p>③</p>  <p>Slot of back case</p> <p>Bracket</p> <p>Indoor monitor</p>	<p>④</p>  <p>With the bracket installed</p>